

## EInet LTC

### Power Factor Controller

Rev. 1.3

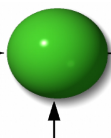

**CONTROL APPLICATIONS Ltd.**

**Supervision & control system**

Tel: +972-3-6474998 Fax: +972-3-6474598 24a Habarzel St. Tel-Aviv, 69710, Israel

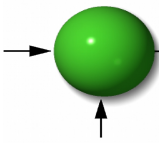

## **Table of Contents**

<b>CHAPTER 1 – Electrical Wiring .....</b>	<b>3</b>
<b>1.1 Electrical connections .....</b>	<b>3</b>
<b>1.2 Electrical Wiring Diagrams.....</b>	<b>5</b>
<b>1.3 Indication Leds. ....</b>	<b>7</b>
<b>1.4 Test Capacitors Screen.....</b>	<b>8</b>
<b>CHAPTER 2 – Power Factor Controller .....</b>	<b>10</b>
<b>2.1 General Information. ....</b>	<b>10</b>
<b>2.2 Controller’s Data Screen.....</b>	<b>12</b>
<b>CHAPTER 3 – Power Factor Controller Settings.....</b>	<b>13</b>
<b>3.1 Transformers Ratio. ....</b>	<b>13</b>
<b>3.2 Vital Setting. ....</b>	<b>16</b>
<b>3.3 Non-vital setting .....</b>	<b>21</b>
<b>3.4 Working range settings .....</b>	<b>23</b>

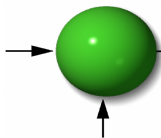

## **CHAPTER 1 – Electrical Wiring**

### **1.1 Electrical connections**

All Connections, except those to the CT core of the *EI*Net LTC Power Factor Controller are made via terminal connector plugs. Recommended max tightening torque for the connector screws is 0.5 Nm.

The CT cores of the *EI*Net LTC Power Factor Controller are located externally on the rear of the instrument and the lead from the leg of the external Current Transformer must pass through in the correct direction.

#### **NOTE!**

Ensure all the connections to the leads of the current transformer wiring are secure and there is no mechanical strain on the wire. The cross section of the leads to the Current transformer must be compatible with the power of the current transformer.

We recommend a power transformer with at least 3VA and the length of the wiring of the transformer should not exceed 5m.

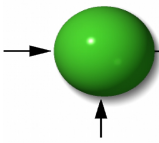

1. Insert the lead from side “K” of the Current Transformers of Line 1 through the hole marked "I1" – "K" of the *ElNet* LTC Power Factor Controller.
2. Repeat the procedure for Line 2 and Line 3 ("I2""I3"/"K").
3. Connect the rest of the connections to the *ElNet* LTC Power Factor Controller by means of terminal connector plugs. All Rear Panel connections are according to the wiring diagram (See Figures 1.1) and are easy to follow.

**WARNING!**

Never allow an open circuit between "K" & "L" of the Current Transformers.

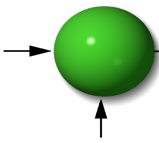

## 1.2 Electrical Wiring Diagrams

### Notice!

The distance between the external current transformer and the Elnet will not exceed 5m

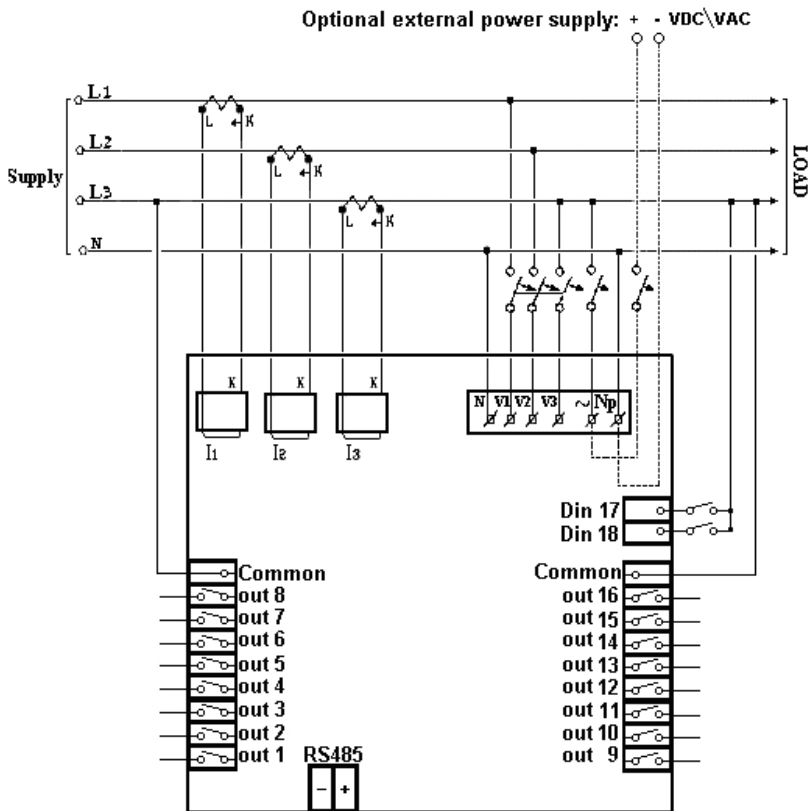
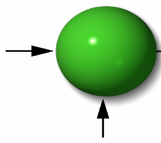

Figure 1.1 – Three Phase Electrical wiring diagram



Pin Designation	Description	Remarks
V1	<b>Line 1</b> - Voltage Supply	Use 6Amp fuse to protect the line
V2	<b>Line 2</b> - Voltage Supply	Use 6Amp fuse to protect the line
V3	<b>Line 3</b> - Voltage Supply	Use 6Amp fuse to protect the line
N	Neutral	Measurement neutral Line
I1	From external Current Transformer on <b>Line1</b>	Note the correct direction to insert the lead
I2	From external Current Transformer on <b>Line2</b>	Note the correct direction to insert the lead
I3	From external Current Transformer on <b>Line3</b>	Note the correct direction to insert the lead
~	Power 110 - 280 VAC	OR 90-250 VDC
Np	Neutral	Neutral of external power supply
<b>Digital Out 1 - 16</b>	Relay outputs for switching the capacitor's contactors.	Recommended operational load <b>up to 5 Amp</b>
<b>Common</b>	Common connector for feeding voltage\neutral to all the contact relay outputs.	
<b>RS485 -</b>	RS485 Comm. (-) Line	
<b>RS485 +</b>	RS485 Comm. (+) Line	

Figure 1.2 – **Connections on the back of the device**

### 1.3 Indication Leds.

In the front panel of the Elnet LTC located 16 indication Leds. Each Led is marked according to the relay output number of the LTC. When the LTC turns on one of its outputs, the relevant Led will turn on accordingly, to indicate which capacitor is on.

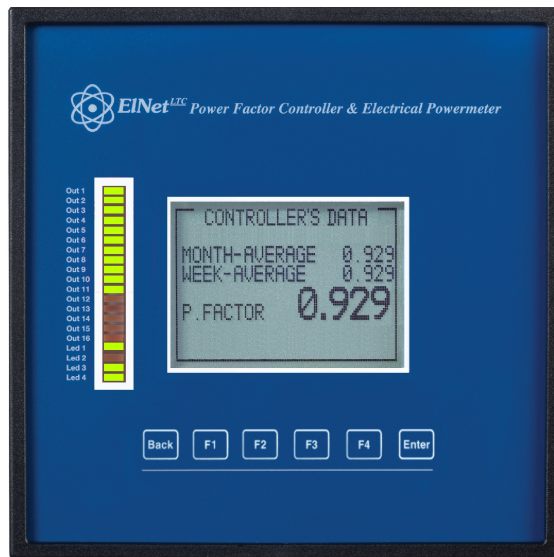
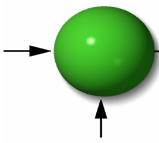

Figure 1.3 – Indication Leds



## 1.4 Test Capacitors Screen

1. From the Main Menu scroll to TECHNICAL and press "Enter".

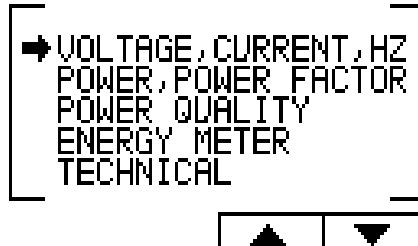

Figure 1.4 – Access the Settings screen

2. The ENTER CODE screen appears.



Figure 1.5 – Enter Code screen

3. The password to activate the Test Relay screen is **789**.
4. Use the buttons F3 & F4 to move the cursor, to set the value use buttons F1 & F2, when finished click "ENTER".



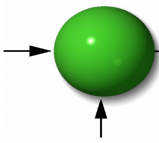

5. The TEST CAP screen will appear.

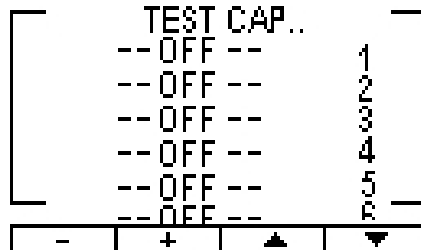
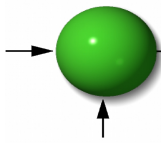

Figure 1.6 – Test Capacitors screen

6. Use the navigation buttons to scroll, force and release the relevant output.
7. When finished press "Back" to return to the main menu.



## **CHAPTER 2 – Power Factor Controller**

### **2.1 General Information.**

*EINet* LTC is a combined **Energy & Power Factor** Controller it enables measurement of power factor and power factor correction by using ON/OFF switching control of capacitors. It also enables automatic identification of capacitors' size and its connection in various methods.

Based on the above mentioned measurements *EINet* LTC corrects the power factor by switching the capacitors.

In addition the *Elnet* LTC can also measure Energy, Power Quality - all the features of *Elnet* LT energy & power meter. (For detailed information of how to operate and use *Elnet* LT features please check the attached *Elnet* LT manual.

In order to access the power factor menus of *Elnet* LTC:

1. In the Main Menu select "POWER, POWER FACTOR" and press "Enter".

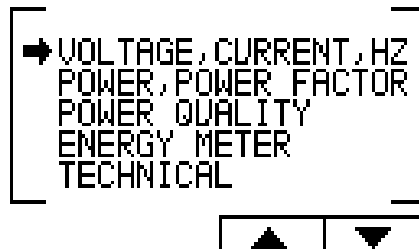

**Figure 2.1 – Main Menu**

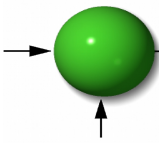

2. The POWER, POWER FACTOR screen appears.

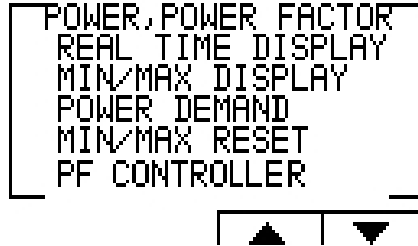

Figure 2.2 – Power, Power Factor screen

3. Scroll to "PF Controller", and press "Enter". The PF CONTROLLER screen appears.

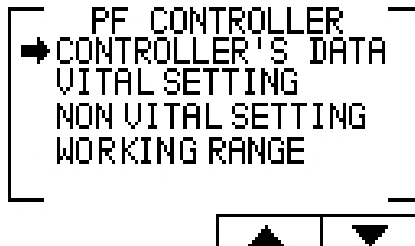
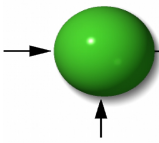

Figure 2.3 – PF Controller screen



## 2.2 Controller's Data Screen.

Selection of "CONTROLLER'S DATA" from the main menu displays monthly and weekly average power factor (from the last power startup) and also real time power factor.

In case of fault one of the following messages appears:

- "**Low Current**" – Appears in case of measured current is lower than in the allowed "Working range" definitions.
- "**High THD**" - Appears in cases of measured current\voltage THD is higher than in the allowed "Working range" definitions.
- "**Volt Range Error**" - Appears in cases of measured voltage is lower\higher than in the allowed "Working range" definitions.
- "**Capacity Load**" - Appears in cases of the system is turned to capacitive.
- "**Need More Capacitors**" – Appears in cases of all the capacitors are ON, however the desirable Set Point is unreachable.

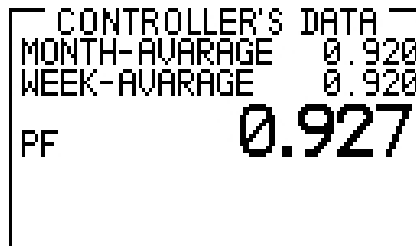
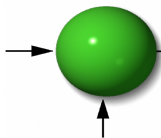

Figure 2.4 – Controller's Data Screen



## CHAPTER 3 – Power Factor Controller Settings

In order to set all values requested for proper operation of the Power Factor Controller, the following settings must be defined: Transformer Ratio, Vital Setting, Non Vital Setting & Working Range.

### 3.1 Transformers Ratio.

1. From Main Menu scroll to TECHNICAL and press "Enter", The Enter Code screen appears.

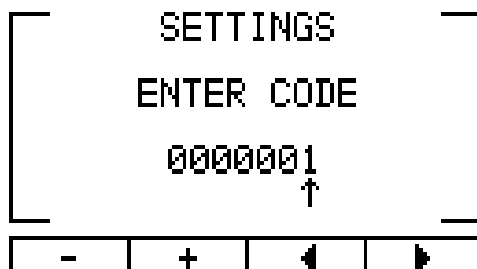
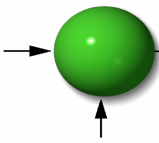

Figure 3.1 - Enter Password

**The password is 1.**

2. Use the buttons F3 & F4 to move the cursor, to set the value use buttons F1 & F2, when finished click "ENTER".



**NOTE!**

If the incorrect password is inserted into the Password field, an Error message appears and the password should be reentered

3. The TECHNICAL screen appears.

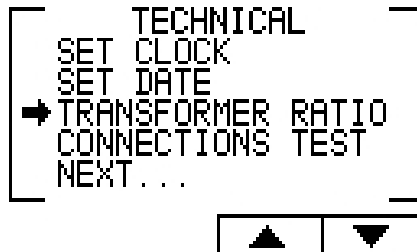
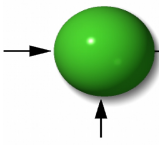

Figure 3.2 – **Technical screen**

4. Scroll to "Transformer Ratio" and press "Enter". The Transformer Ratio screen appears.



5. In order to set the **Current Transformers** ratio, scroll to Current Trans and press "Enter".

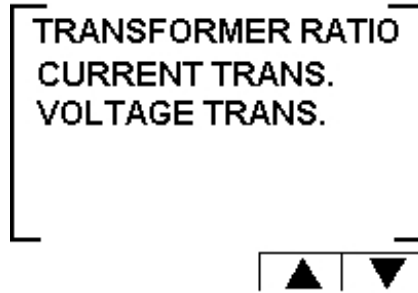

Figure 3.3 – **Transformer Ratio.**

6. The Current Transformer screen appears.

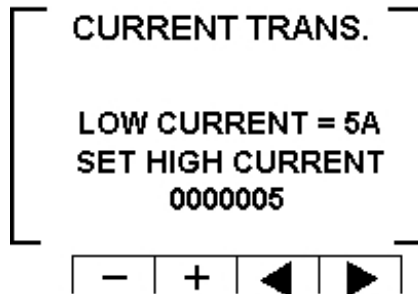
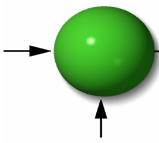

Figure 3.4 – **Changing Transformer Ratio.**

7. Use the buttons F3 & F4 to move the cursor, to set the value use buttons F1 & F2, when finished click "ENTER".



8. In order to set the **Voltage Transformers** ratio, scroll to Voltage Trans and press "Enter".
9. Use the buttons F3 & F4 to move the cursor, to set the value use buttons F1 &F2, when finished click "ENTER".

### 3.2 Vital Setting.

In order to define the Vital Setting, you must access the PF CONTROLLER screen by repeating steps from chapter 2, paragraphs 1,2,3.

1. Once the PF CONTROLLER screen appears, scroll to Vital Setting and press "Enter". The Vital Setting screen appears.

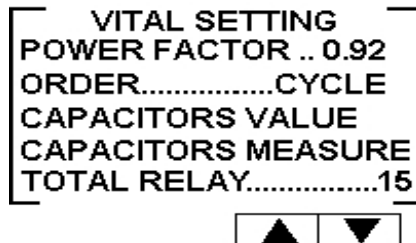
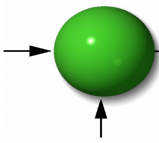

Figure 3.5 – Vital Setting screen.





### **3.2.1 Setting the Power Factor Set Point:**

1. Scroll down to Power Factor and press "Enter".
2. The Power Factor setting screen appears.

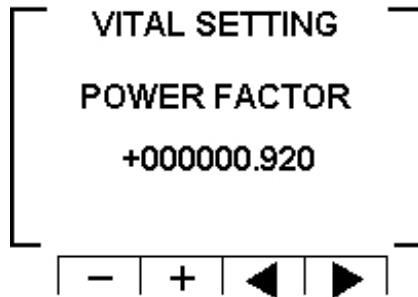
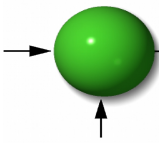

Figure 3.6 – Power Factor change.

3. Use the buttons F3 & F4 to move the cursor, to set the value use buttons F1 &F2, when finished click "ENTER".

### **3.2.2 Changing the Capacitors Connection Order:**

1. At the Vital Setting screen scroll down to "ORDER".
2. Each time you press Enter at the line indicating "ORDER", the connection order options will be changed from the following possibilities: "RANDOM", "FIRST", "CYCLE".
3. The capacitors chosen for power factor correction are chosen according to their size, meaning that it chose the minimal number of the capacitors for achieving the requested value of the power factor.



4. There are a number of methods as following:

**"RANDOM"** - this method enables random selection of equally-sized capacitors. In this method after a certain period, the number of the working hours, of all equally-sized capacitors will be equal.

**"FIRST"** - this method enables fixed selection, meaning a certain capacitor will always be first and the other will always be second and third and so on – this method is recommended in places preferring unequal working hours of the capacitors.

**"CYCLE"** - whenever there are a few capacitors of equal size there is a possibility to use the "cycle" method so that the number of working hours will be equally divided between these capacitors.

### 3.2.3 Capacitor's Value setting:

1. In order to define manually the values of the capacitors which are used in the system, at the Vital Setting screen scroll down to Capacitors Value, and press "Enter".
2. The Capacitor Value screen appears.

KVA	CAPACITOR
1.000	1
----	2
----	3
----	4
----	5
----	6

Figure 3.7 – Capacitor Value screen.

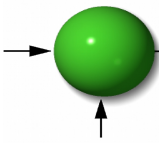

3. In order to manually define the value of the capacitor step, use F3 & F4 buttons to scroll between steps, and press "Enter" in order to access the value setup.
4. The Capacitors Value screen appears, Use the buttons F3 & F4 to move the cursor, to set the value use the buttons F1 & F2, when finished click "ENTER".

### 3.2.4 Capacitor's Value measure:

1. The Elnet LTC enables true capacitors value measure for capacitors 1 up to 16.
2. In order to measure and automatically define the values of the capacitors which are used in the system, at the Vital Setting screen scroll down to Capacitors Measure, and press "Enter".
3. The Value Measure screen appears.

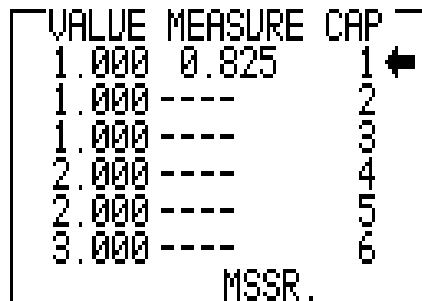
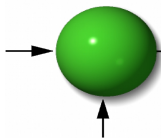

Figure 3.8 – Value measure of the capacitors.



4. Once the Value Measure screen appeared, the LTC will automatically begin measuring process. It will scan and measure each capacitor step, one by one, the whole process may take a few minutes. (During the scan process the indications Output Leds will turn On according to the scanned output progress).
5. Once the measuring process is finished, the measured values appear on screen.
6. The column "MEASURE" indicates the measured values.
7. The column "VALUE" indicates the capacitor's value as defined by the user.
8. The "RND" button enables correction of the measured values to the closest rounded value under the condition that the difference between the capacitors doesn't exceed 10%.
9. The "SAVE" button enables saving the measured (and/or rounded) values instead of the values entered by the user at the previous screen "capacitors value".

### **3.2.5 Total Relay:**

1. In order to set the number of the capacitors steps in the system, at the Vital Setting screen scroll down to Total Relay, and press "Enter".
2. The Total Relay screen appears. Use the buttons F3 & F4 to move the cursor, to set the value use buttons F1 & F2, when finished click "ENTER".

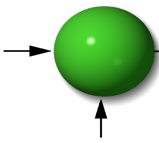

### 3.3 Non-vital setting

In order to define the Non Vital Setting, you must access the PF CONTROLLER screen by repeating steps from chapter 2, paragraphs 1,2,3.

1. Once the PF CONTROLLER screen appears, scroll to Non Vital Setting and press "Enter".
2. The Non Vital Setting screen appears.

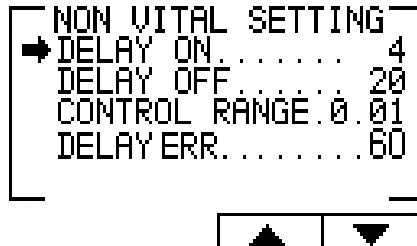
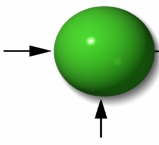

Figure 3.9 – Non vital setting.

#### 3.3.1 "DELAY ON":

1. Delay On enables setting the delay (seconds) between the decision of connecting the capacitor and its actual connection. This delay is meant to minimize the number of connections/disconnections of the capacitors during control of the desired power factor value.
2. In order to change the delay on, scroll to DELAY ON and press "Enter". The Delay On screen appears.
3. Use the buttons F3 & F4 to move the cursor, to set the value use buttons F1 & F2, when finished click "ENTER".



### **3.3.2 "DELAY OFF":**

1. Delay Off enables setting the delay (seconds) between the decision of disconnecting the capacitor and its actual disconnection. This delay is meant to minimize the number of connections/disconnections of the capacitors during control of the desired power factor value.
2. In order to change delay off , scroll to DELAY OFF and press "Enter". The Delay OFF screen appears.
3. Use the buttons F3 & F4 to move the cursor, to set the value use buttons F1 & F2, when finished click "ENTER".

### **3.3.3 "CONTROL RANGE":**

1. Control Range enables the user to define the working range of the capacitors in performing power factor correction. When the "control range" = 0.01 the system is looking for the minimal capacitors number for performing power factor correction from the desired value (for example, 0.92) to the value  $0.93 = 0.92 + 0.01$  (control range). From this point, the system is looking for the minimal capacitors' combination required, for reaching the power factor of 0.93 and its disconnecting capacitors accordingly.
2. In order to change Control Range scroll to Control Range line and press "Enter". The Delay Control Range screen appears.
3. Use the buttons F3 & F4 to move the cursor, to set the value use buttons F1 & F2, when finished click "ENTER".

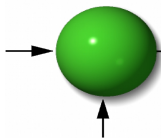

### **3.3.4 "DELAY ERR":**

1. Delay ERR enables setting the delay (seconds) after an error accrue (for error list please check chapter 2.2) and between the return to normal operation mode. This delay is meant to minimize the number of connections/disconnections of the capacitors during control of the desired power factor value.
2. In order to change delay time, scroll to DELAY ERR and press "Enter". The Delay ERR screen appears.
3. Use the buttons F3 & F4 to move the cursor, to set the value use buttons F1 & F2, when finished click "ENTER".

## **3.4 Working range settings**

Working range settings enable defining limits for current, voltage, THD V and THD I values. In order to define the Working Range Setting, you must access the PF CONTROLLER screen by repeating steps from chapter 2, paragraphs 1,2,3.

1. Once the PF CONTROLLER screen appears, scroll to Working Range and press "Enter". The Working Range screen appears.

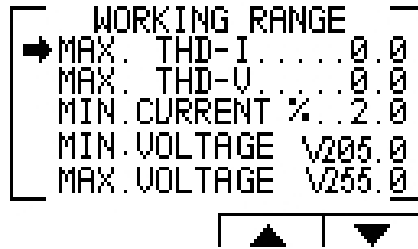
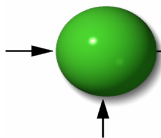

Figure 3.10 – Working range settings.

#### 3.4.1 "MAX. THD I" setting:

1. Enables disconnection of all the capacitors whenever the actual THD I value exceeds the value which was defined by the user. When THD I = 0 this option is disabled.
2. In order to change the Max. THD-I, scroll to Max. THD-I line and press "Enter". The Max. THD-I screen appears.
3. Use the buttons F3 & F4 to move the cursor, to set the value use buttons F1 & F2, when finished click "ENTER".





### **3.4.2 "MAX. THD V" setting:**

1. Enables disconnection of all the capacitors whenever the actual THD V value exceeds the value which was defined by the user. When THD V = 0 this option is disabled.
2. In order to change the Max. THD-V, scroll to Max. THD-V line and press "Enter". The Max. THD-V screen appears.
3. Use the buttons F3 & F4 to move the cursor, to set the value use buttons F1 & F2, when finished click "ENTER".

### **3.4.3 "MIN. CURRENT %" setting:**

1. Enables defining value for minimal current under which power factor correction is not required, the value entered as % of the maximum current at the secondary current transformer.
2. In order to change the Min. Current %, scroll to Min. Current % line and press "Enter". Min. Current % screen appears.
3. Use the buttons F3 & F4 to move the cursor, to set the value use buttons F1 & F2, when finished click "ENTER".

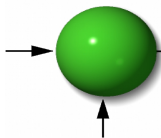

#### **3.4.4 "MIN. VOLTAGE" setting:**

1. Enables defining voltage low limit value, under this value all the capacitors will be disconnected.
2. In order to change the Min. Voltage, scroll to Min. Voltage line and press "Enter". The Min Voltage screen appears.
3. Use the buttons F3 & F4 to move the cursor, to set the value use buttons F1 & F2, when finished click "ENTER".

#### **3.4.5 "MAX. VOLTAGE" setting:**

1. Enables defining voltage high limit value, above this value all the capacitors will be disconnected.
2. In order to change the Max. Voltage, scroll to Max. Voltage line and press "Enter". The Max Voltage screen appears.
3. Use the buttons F3 & F4 to move the cursor, to set the value use buttons F1 & F2, when finished click "ENTER".