

**SANWA®**



**PC700**

**DIGITAL MULTIMETER**

**INSTRUCTION MANUAL**



## Table of Contents

<b>[1] SAFETY PRECAUTIONS</b>	
1-1	Explanation of Warning Symbols ..... 1
1-2	Warning Instructions for Safe Use ..... 2
1-3	Overload Protection ..... 3
<b>[2] APPLICATIONS AND FEATURES</b>	
2-1	Applications ..... 4
2-2	Features ..... 4
<b>[3] Parts Identification</b>	
3-1	Multimeter and Test Leads ..... 5
3-2	Display ..... 7
<b>[4] DESCRIPTION OF FUNCTIONS</b>	
4-1	Power Switch/Function Selector ..... 8
4-2	Auto Power Saving ..... 8
4-3	Low Battery Indication ..... 9
4-4	Measuring Function Selection ..... 9
4-5	Range Hold ..... 10
4-6	Data Hold ..... 10
4-7	Beeper Control ..... 10
4-8	PC (Personal Computer) Interface ..... 11
4-9	Test Leads Improper Connection Warning ..... 12
4-10	Relative Measurement ..... 12
4-11	Terms ..... 12
<b>[5] Measuring procedures</b>	
5-1	Pre-operational Check ..... 14
5-2	AC Voltage ( $\tilde{V}$ ) / Frequency (Hz) Measurement ..... 16
5-3	DC/AC Voltage (V) Measurement ..... 19
5-4	DC/AC Voltage (mV) , Logic-Level Frequency ( $\square$ Hz) and Duty Cycle ( $\square$ D%) Measurement ..... 21
5-5	AC Voltage ( $m\tilde{V}$ ) / Frequency (Hz) Measurement ..... 24
5-6	Resistance ( $\Omega$ ) Measurement ..... 26
5-7	Continuity Check (•  ) ) ..... 28
5-8	Capacitance ( $\text{H}$ ) Measurement, Diode ( $\rightarrow $ ) Test ..... 30
5-9	DC/AC Current (A), AC Current ( $m\tilde{A}$ , $\mu\tilde{A}$ , $\tilde{A}$ )/ Frequency (Hz) Measurement ..... 34
5-10	Measurements with Separately Available Accessories ..... 40

<b>[6] MAINTENANCE</b>	
6-1	Simple Examination ..... 44
6-2	Calibration ..... 44
6-3	Battery and Fuse Replacement ..... 45
6-4	Storage ..... 46
<b>[7] AFTER-SALE SERVICE</b>	
7-1	Warranty and Provision ..... 47
7-2	Repair ..... 47
7-3	SANWA web site ..... 48
<b>[8] SPECIFICATIONS</b>	
8-1	General Specifications ..... 49
8-2	Measuring Range and Accuracy ..... 51

## [1] SAFETY PRECAUTIONS

**\*Before use, read the following safety precautions.**

This instruction manual explains how to use your digital multimeter PC700. Before using, read through this manual to reduce the risk of fire, electric shock, and/or injury. And save it together with the product so that you can refer to the manual as necessary.

Use the instrument only as specified in this manual or the protection provided by the instrument may be impaired.

The instructions given under the headings of " ⚠ WARNING" and must be followed to prevent accidental burn and electric shock.

### 1-1 Explanation of Warning Symbols

The meanings of the symbols used in this manual and attached to the product are as follows.

⚠ :Extremely-important instructions for safe use

- WARNING identifies conditions and actions that could result in accidental burn and electric shock.
- CAUTION identifies conditions and actions that could cause damage the instrument.

⚡ :Do not touch! Possible high voltage.

⏚ :Ground

▶ :Diode

Hz:Frequency

⏏ :Fuse

•••):Beep

⏏Hz:Logic-Level Frequency

⏏:Direct Current(DC)

⏏:Capacitor

⏏D%:Duty Cycle

~:Alternate Current (AC)

Ω:Resistance

□ : Double Insulation or Reinforced

### 1-2 Warning Instructions for Safe Use

#### ⚠ WARNING

1. Do not use the instrument if the meter or test leads look damaged.
2. Be sure to use the specified fuse.  
Neither use unspecified fuse nor short-circuit the fuse holder.
3. Do not apply higher voltage or current than the max. ratings by each function. (See 1-3)
4. Use caution when working with voltages above 33 V ac rms, 46.7 V ac peak, or 70 V dc. These voltages pose a shock hazard.
5. Do not use the meter to measure lines that may have inductive voltage or surge voltage (e.g. motors) because the input voltage may exceed the maximum rated voltage.
6. Never operate the meter with the case or battery lid removed.
7. Remove test leads from the meter before opening the meter case for replacing the battery or fuse.
8. Never attempt to repair or modify the instrument, except for battery and fuse replacement.
9. Do not use any unspecified type of test leads.
10. Keep your fingers behind the finger guards of the test leads while measurement.
11. Connect the common test lead (Black) before you connect the live test lead (Red). Disconnect the live test lead first.
12. Make sure the function, range, and terminals are properly set.
13. Do not switch the function, range, or the plugs to another while measurement.
14. Do not operate the meter when it is wet or with wet hands.

#### ⚠ CAUTION

Incorrect measurement may be performed in a ferromagnetic or intense electric field near transformers, high-current circuits, and radio equipments.

### 1-3 Overload Protection

Function	Measuring terminal	Max. Rated Input	Overload Protection
[Hz $\tilde{V}$ ], [ $\tilde{V}$ ]	 and <b>COM</b>	1000V dc/ac	600Vrms
[ $\frac{D\%}{mHz}$ $\tilde{mV}$ ], [Hz $\tilde{mV}$ ]		10V dc/ac	
[ $\Omega$ ], [ $\bullet$ ]] [- + →]		$\Delta$ Do not apply any voltage or current.	
[ $\mu A$ $\tilde{Hz}$ ], [ $A$ $\tilde{mA}$ $\tilde{Hz}$ ]	<b>mA</b> $\mu$ <b>A</b> and <b>COM</b>	600mA dc/ac $\Delta$ Do not apply any voltage.	0.63A/500V Fuse Breaking capacity: 50kA
[ $A$ $\tilde{mA}$ $\tilde{Hz}$ ]	<b>A</b> and <b>COM</b>	10A dc/ac $\Delta$ Do not apply any voltage.	12.5A/500V Fuse Breaking capacity: 20kA

## [2]APPLICATIONS AND FEATURES

### 2-1 Applications

This instrument is a portable digital multimeter designed to measure light electric circuits. The instrument offers not only measurements for small communication equipments, home electric appliances, output from a wall socket, and many batteries, also circuit analyses with additional functions.

### 2-2 Features

- Compliant with IEC61010-1 CAT. III 600V, CAT. II 1000V, and safe design using fuses with large number of breaking capacity.
- 9999 count display (ACV, DCV, Hz)
- Fast response display  
(Numeric parts: 5 times/Sec. Bar graph part: 60 times/Sec.)
- Dual Display shows "Voltage or Current and its Frequency", and "AC components and DC components of Voltage or Current"
- Maximum DC/AC voltage measurement resolution: 0.01 mV
- Frequency (Sensitivity selectable),  
Wide capacitance range (0.01nF to 25.00mF)
- Relative mode with auto ranging
- PCLink7 (separately available software) allows you to download logged data into your PC with USB optical communication unit (KB-USB7)

### [3] Parts Identification

#### 3-1 Multimeter and Test Leads

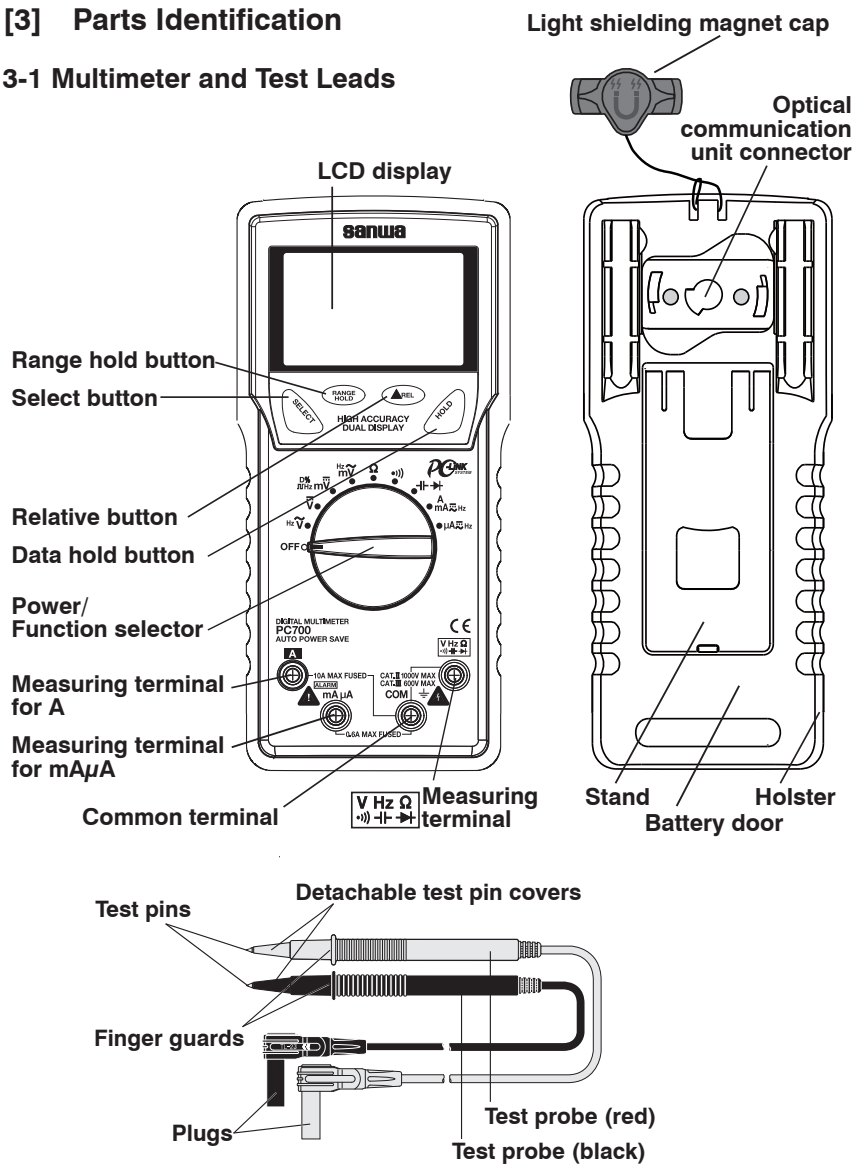

**Test leads TL-23a**

With the detachable test pin covers: CAT. III 600V  
 Without the detachable test pin covers: CAT. II 1000V

#### How to detach the light shielding magnet cap

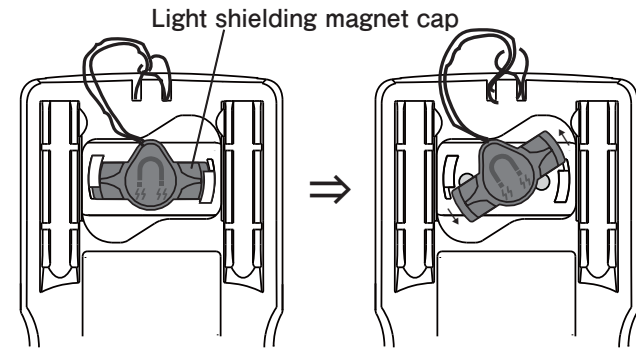

Turn the light shielding magnet cap counterclockwise to detach.

#### An application of the light shielding magnet cap

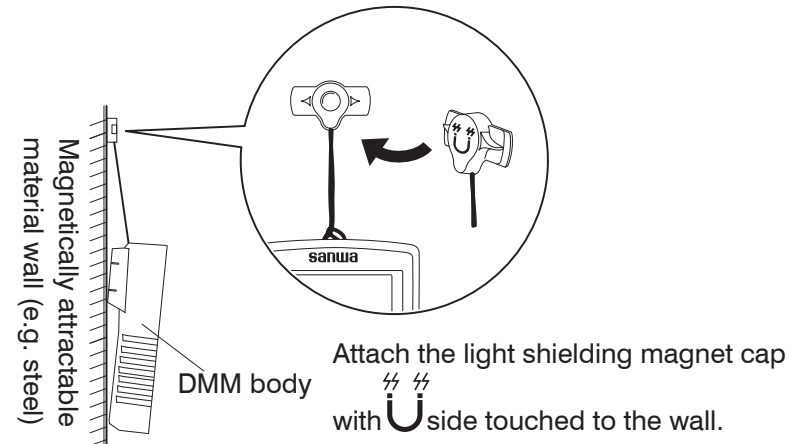

**Note:**

Keep the light shielding magnet cap away from cellular phones, analog watches, floppy disks, magnetic cards, magnetic tapes, and magnetic tickets. Otherwise, the memorized information may be lost.

### 3-2 Display

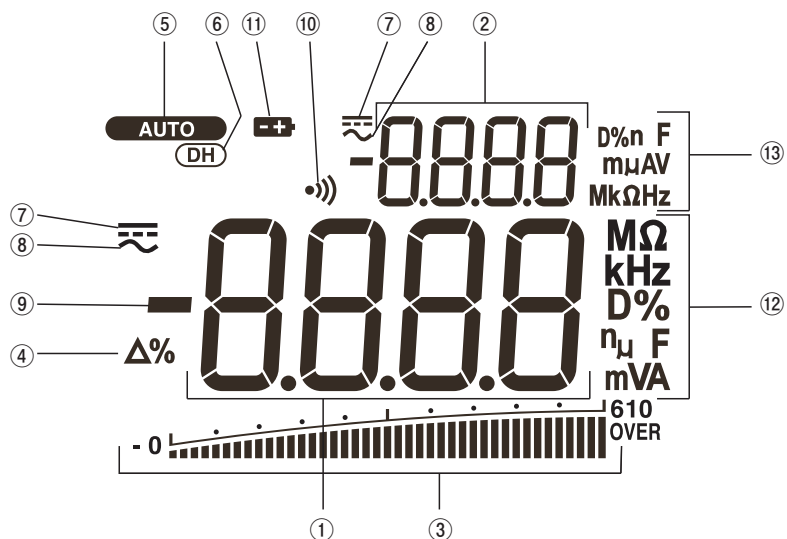

①	Main display
②	Sub display
③	Analog bar graph
④	Relative mode indicator
⑤	Auto range mode indicator
⑥	Data hold indicator
⑦	DC measurement indicator
⑧	AC measurement indicator
⑨	Polar character
⑩	Continuity check indicator
⑪	Low battery voltage indicator
⑫	Unit of readings for main display
⑬	Unit of readings for sub display

## [4] DESCRIPTION OF FUNCTIONS

### 4-1 Power Switch/Function Selector

Turn the switch to turn on/off the power and select a measuring function. All segments of the LCD display will be turned on for 1 seconds after power-on, and then the meter will be ready to use.

#### Note:

The push buttons between the display and the function selector work differently depending on how long you press. In this manual, "press" means pressing momentary and "press and hold for 1 sec. or more" means pressing longer.

### 4-2 Auto Power Saving

The Auto Power Saving mode turns the meter off automatically after approximately 30 minutes of no activities. While the Auto Power Saving mode, following activities set the auto power saving back.

- 1) Function selector or push button operations
- 2) Non-OL readings in the  $\Omega$  function, diode test, or continuity check, non-zero readings in the Duty cycle/Frequency measurement functions, or significant measuring readings of above 512 counts in the other function ranges

While data communication to your PC is in use, Auto Power Saving mode will be temporarily cancelled.

#### 4-2-1 How to get back from the Auto Power Saving

Press the SELECT, RANGE HOLD,  $\triangle$  REL, or HOLD button, or disconnect the object to measure and turn the power switch off and then back on, and select a function before connecting the object.

#### 4-2-2 How to disable the Auto Power Saving

Press the SELECT button while turning the meter power on. Release the SELECT button after **AUTO** is turned off. (All segments of the display turn on after power-on.) Then the meter will be ready to use.

Turn the power switch OFF and then back on to resume.

##### Note:

Even in the Auto Power Saving mode, approx.  $50\mu\text{A}$  will be consumed. When in the auto power saving mode, intense light like the direct sunlight into the optical communication unit on the back of the DMM increases the consumption current. Mount the attached light shielding magnet cap on the optical communication unit connector when not in use. Always turn the power switch to the OFF position when the meter is not in use for a long time.

#### 4-3 Low Battery Indication

Decreasing the internal battery voltage to approx. 7V due to wearing down turns on the **+** indicator on the LCD display. Replace the battery with new one when the indicator turns on.

Use under "Low Battery" may cause malfunctions.

#### 4-4 Measuring Function Selection

At each position of the function selector, press SELECT button (⇒) to select measuring functions as follows.

\* Dual display: [Main display/Sub display]

- [Hz  $\tilde{V}$ ] : [  $\tilde{V}/\text{Hz}$  ] ⇔ [ Hz/  $\tilde{V}$  ]
- [  $\tilde{V}$  ] : [  $\tilde{V}$  ] ⇔ [  $\tilde{V}/\tilde{V}$  ]
- [  $\frac{D\%}{\mu\text{Hz}} m\tilde{V}$  ] : [  $m\tilde{V}$  ] ⇒ [  $m\tilde{V}/m\tilde{V}$  ] ⇒ [  $\mu\text{Hz}$  ] ⇒ [ D% ] ⇒ [  $m\tilde{V}$  ] ⇒ ...
- [  $\frac{\text{Hz}}{m\tilde{V}}$  ] : [  $m\tilde{V}/\text{Hz}$  ] ⇔ [ Hz/  $m\tilde{V}$  ]
- [  $\Omega$  ] : [  $\Omega$  ] (SELECT button will not be used here.)
- [  $\bullet$  ) ) ] : [  $\bullet$  ) ) ] (SELECT button will not be used here.)
- [  $\dashv$   $\dashv$  ] : [  $\dashv$  ] ⇔ [  $\dashv$  ]
- [  $\frac{\text{A}}{mA} \tilde{A}$  ] : [ (m)  $\tilde{A}$  ] ⇒ [ (m)  $\tilde{A}$  / (m)  $\tilde{A}$  ] ⇒ [ (m)  $\tilde{A}/\text{Hz}$  ] ⇒ [ (m)  $\tilde{A}$  ] ⇒ ...

- [  $\mu\text{A}$   $\tilde{A}$  ] : [  $\mu\tilde{A}$  ] ⇒ [  $\mu\tilde{A}/\mu\tilde{A}$  ] ⇒ [  $\mu\tilde{A}/\text{Hz}$  ] ⇒ [  $\mu\tilde{A}$  ] ⇒ ...

##### Note:

The last selection of each function will be saved as power up default for repeat measurement convenience.

#### 4-5 Range Hold

Press the RANGE HOLD button to select manual-ranging, and the meter will remain in the range it was in. (**AUTO** turns off.) In the manual-ranging mode, press the button again to step through the ranges. Select an appropriate range making sure units and decimal point positions. To resume auto-ranging mode, press and hold the button for 1 second or more.

##### Note:

Manual ranging mode is not available in the Hz functions.

#### 4-6 Data Hold

Press HOLD button to freeze present reading for later view. (DH indicator turns on.) Input fluctuation will not reflect on the indicated value. Press the HOLD button again to disable the data hold feature and go back to the normal measurement mode. (DH indicator turns off.)

##### Note:

Function changes or functional operations will cancel the data hold feature.

#### 4-7 Beeper Control

Press the RANGE HOLD button while turning the meter power on to disable the beeper. Release the RANGE HOLD button after **•••** is turned off. (All segments of the display turn on right after power-on.) Then the meter will be ready to use. Turn the power switch OFF and then back on to resume.

##### Note:

The beeper for the continuity check and the plug improper connection warning will not be disabled.

#### 4-8 PC (Personal Computer) Interface

The instrument equips with an optical isolated interface port at the meter back for data communication. KB-USB7, dedicated USB optical communication unit (separately available), and PCLink7, dedicated software, allow you to transfer real time readings and internally logged data to your PC. For more information, see the "HELP" for PCLink7 (PC linkage software).

USB Optical Communication Unit  
(KB-USB7)

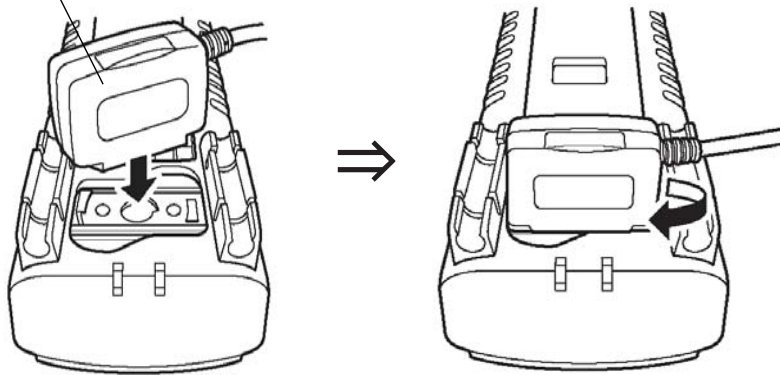

#### Optical Communication Unit Connection

**Note:**

Intense light like the direct sunlight into the optical communication unit on the back of the DMM increases the consumption current. Mount the attached light shielding magnet cap on the optical communication unit connector when not in use.

#### 4-9 Test Leads Improper Connection Warning

The meter beeps as well as displays "InEr" to warn the user against possible damage to the meter due to test leads improper connections to the mA  $\mu$ A, or A input jacks when other function (like voltage function) is selected. (Temperature measurement function is an exception.)

**Note:**

"InEr" warning may be indicated due to weak battery even if the test leads are connected properly.

#### 4-10 Relative Measurement

Press the  $\Delta$  REL button to activate the relative measurement mode and  $\Delta$  indicator turns on. The relative measurement mode offsets the meter to display relative values against a reference. The meter displays its readings subtracting the reading at the moment the  $\Delta$  REL button is pressed. Press  $\Delta$  REL button again to exit the relative measurement mode. This function works only on the main display.

#### 4-11 Terms

##### Analog bar graph

The analog bar graph provides a visual indication of measurement like a traditional analog meter needle.

##### Average sensing RMS calibrated

RMS (Root-Mean-Square) is the term used to describe the effective or equivalent DC value of an AC signal. Most digital multimeters use average sensing RMS calibrated technique to measure RMS values of AC signals. This technique is to obtain the average value by rectifying and filtering the AC signal. The average value is then scaled upward (calibrated) to read the RMS value of a sine wave. In measuring pure sinusoidal waveform, this technique is fast, accurate and cost effective. In measuring non-sinusoidal waveforms, however, significant errors can be introduced because of different scaling factors relating average to RMS values.



## [5] Measuring procedures

### 5-1 Pre-operational Check

#### ⚠ WARNING

1. Do not use the instrument if the meter or test leads look damaged.
2. Make sure the test leads and the fuse are not broken.

#### ⚠ CAUTION

Make sure the low battery indicator is off after power-on. Replace the battery with new one if the indicator is on.

Perform pre-operational check for safety.

(Inspection using continuity check)

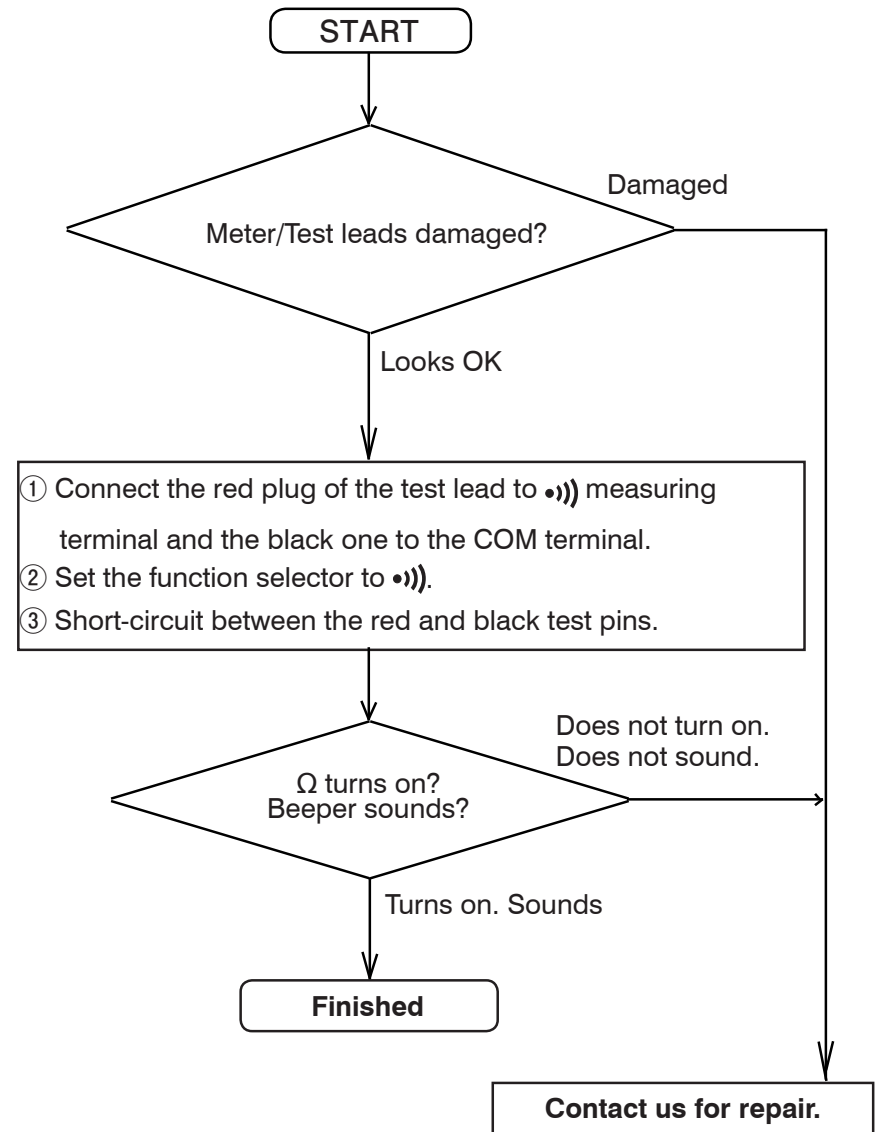
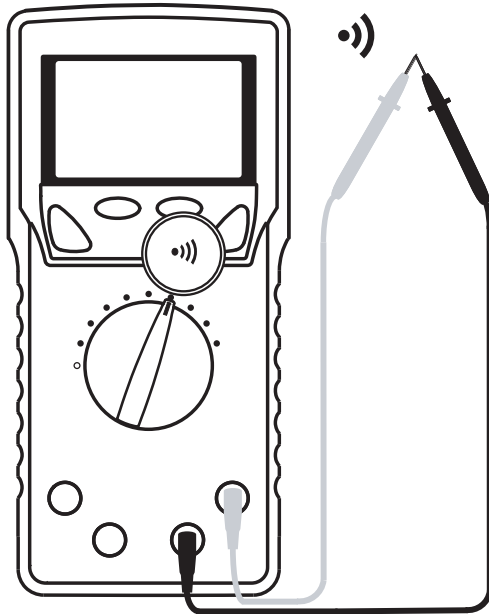

\*In the case nothing is displayed, check for the battery.

## 5-2 [Hz $\tilde{V}$ ] (Max. rated input voltage: 1,000V dc/ac)

### • AC Voltage ( $\tilde{V}$ )/Frequency (Hz) Simultaneous Measurement

#### ⚠ WARNING

1. Do not apply any input signal exceeding the max. rated input voltage.
2. Do not switch the function selector while measuring.
3. Keep your fingers behind the finger guards of the test leads while measurement.

#### 1) What to measure

- $\tilde{V}$  (ACV): Sine wave voltages such as output from a wall socket.
- Hz (Frequency): Frequency on a AC circuit.

#### 2) Measuring ranges

- $\tilde{V}$  : 9.999V, 99.99V, and 999.9V
- Hz: 15.00Hz to 10.00kHz (Auto ranging)

#### 3) Measuring procedure

- ① Connect the red plug of the test lead to the VHz measuring terminal and the black one to the COM terminal.
- ② Set the function selector to Hz  $\tilde{V}$ .
- ③ Press the SELECT button to select a display style.
- ④ Apply the test pins (Red and Black) to the object to measure.
- ⑤ Read the display.

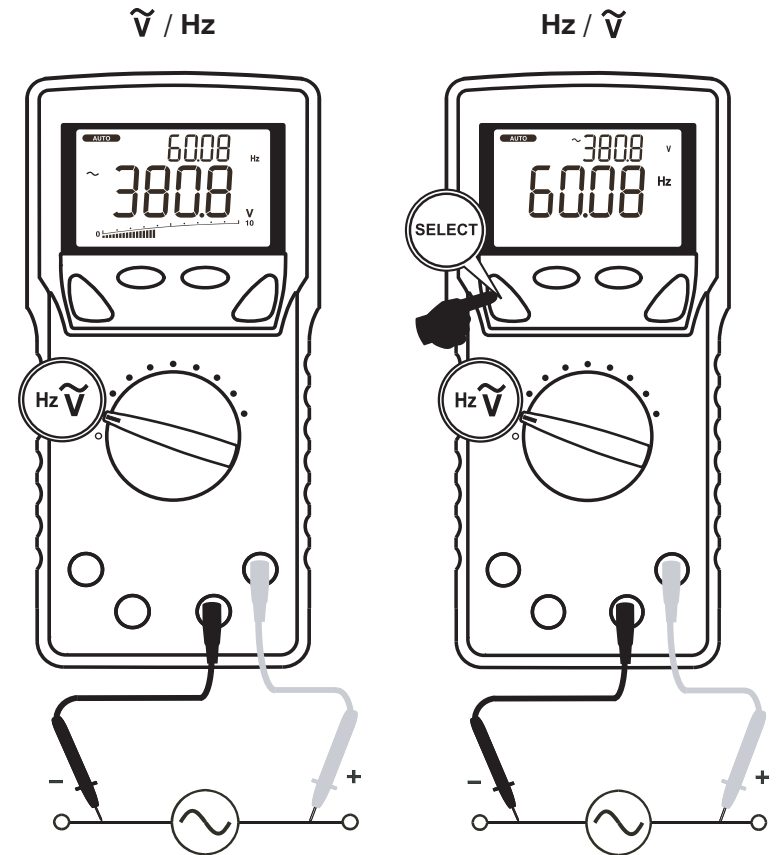

**Note:**

Hz input sensitivity varies automatically with a selected voltage range. 9.999V range has the highest sensitivity and the 999.9V range has the lowest. Auto ranging measurements normally set the most appropriate trigger level. You can also press the RANGE HOLD button to select another trigger level (voltage range) manually.

If the Hz reading becomes unstable, select higher voltage range to avoid electrical noise. If the reading shows zero, select lower voltage range.

Range	Frequency measurement (Hz) Input sensitivity (Sine wave)	Frequency range
9.999V	2.5V	15.00Hz ~ 10.00kHz
99.99V	25V	
999.9V	100V	

The display style of [Hz/ $\tilde{V}$ ] does not show the bar graph. As a normal condition, non-connected test leads may cause unstable readings.

**5-3 [  $\tilde{V}$  ] (Max. rated input voltage: 1,000V dc/ac)**

- DC Voltage( $\bar{V}$ ) measurement
- DC Voltage( $\bar{V}$ )/AC Voltage( $\tilde{V}$ ) simultaneous measurement

**⚠ WARNING**

1. Do not apply any input signal exceeding the max. rated input voltage.
2. Do not switch the function selector while measuring.
3. Keep your fingers behind the finger guards of the test leads while measurement.

- 1) What to measure
  - $\bar{V}$  (DC Voltage): Batteries, DC circuit voltages, etc.
  - $\bar{V}/\tilde{V}$  (DC voltage component/AC voltage component)
- 2) Measuring ranges
  - $\bar{V}$ ,  $\bar{V}/\tilde{V}$  : 9.999V, 99.99V, 999.9V
- 3) Measuring procedure
  - ① Connect the red plug of the test lead to the V measuring terminal and the black one to the COM terminal.
  - ② Set the function selector to  $\bar{V}$ .
  - ③ Press the SELECT button to select a function you want to perform.
  - ④ Apply the test pins (Red and Black) to the object to measure.
  - ⑤ Read the display.

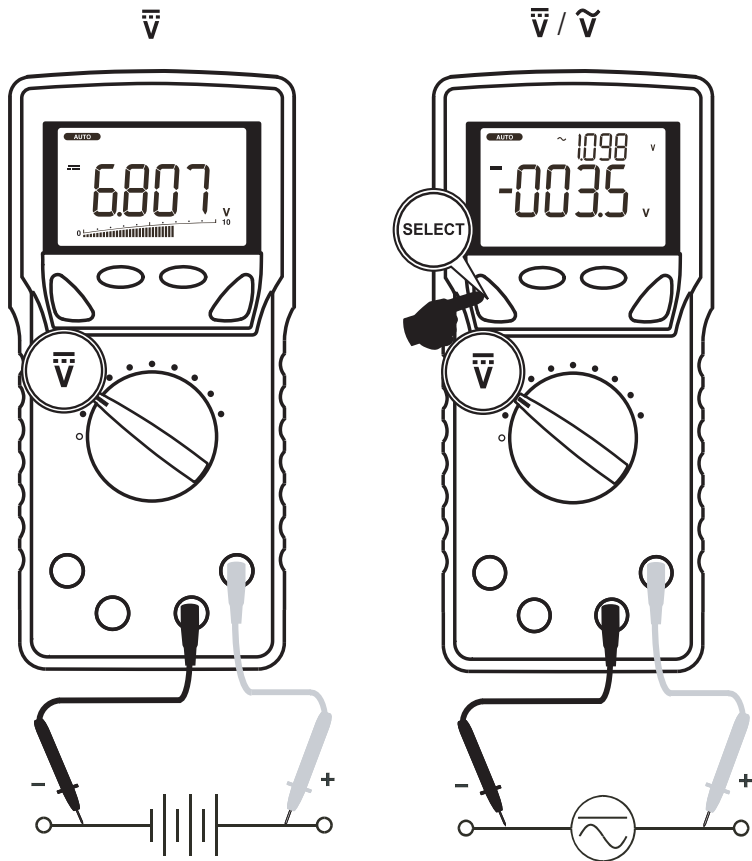

**Note:**

- The display style of  $[m\bar{V} / m\tilde{V}]$  does not show the bar graph.

**5-4  $[ \frac{D\%}{\mu\text{Hz}} m\bar{V} ]$  (Max. rated input voltage: 10V dc/ac)**

- DC voltage (m $\bar{V}$ ) measurement
- DC Voltage (m $\bar{V}$ )/AC Voltage(m $\tilde{V}$ ) simultaneous measurement
- Logic-level frequency (  $\mu\text{Hz}$  ) measurement
- Duty cycle (  $\mu\text{D}\%$  ) Measurement

**⚠ WARNING**

1. Do not apply any input signal exceeding the max. rated input voltage.
2. Do not switch the function selector while measuring.
3. Keep your fingers behind the finger guards of the test leads while measurement.

1) What to measure

- m $\bar{V}$  (DC voltage): DC circuit voltage lower than 600mV
- m $\bar{V}$ /m $\tilde{V}$  (DC voltage component/AC voltage component)
- $\mu\text{Hz}$ (Logic level frequency): 3V, 5V logic circuit frequency
- $\mu\text{D}\%$ (Duty cycle): Logic level signal duty cycle (Square wave)

2) Measuring ranges

- m $\bar{V}$ , m $\bar{V}$ /m $\tilde{V}$  : 60.00mV and 600.0mV
- $\mu\text{Hz}$ : Auto ranging, 5.000Hz to 1.000MHz (Square wave)
- $\mu\text{D}\%$ : 0.00% to 100.0% (Square wave 5Hz to 10kHz)

3) Measuring procedure

- ① Connect the red plug of the test lead to the VHz measuring terminal and the black one to the COM terminal.
- ② Set the function selector to  $\frac{D\%}{\mu\text{Hz}} m\bar{V}$ .
- ③ Press the SELECT button to select a function you want to perform.
- ④ Apply the test pins (Red and Black) to the object to measure.
- ⑤ Read the display.

mV̄

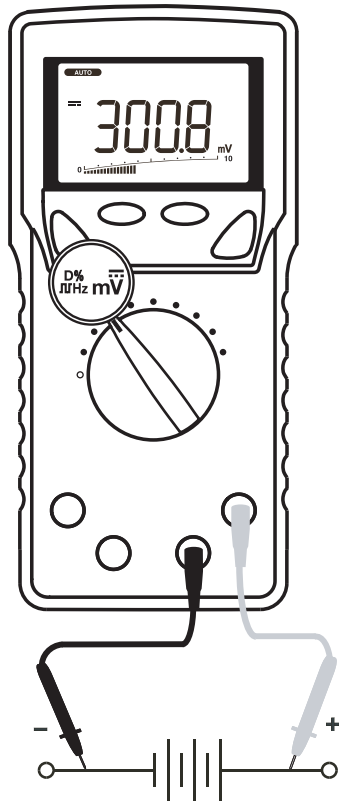

mV̄ / mV̂

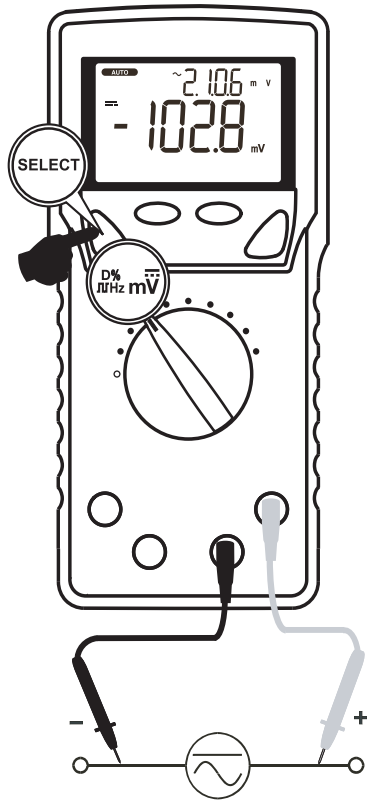

μHz

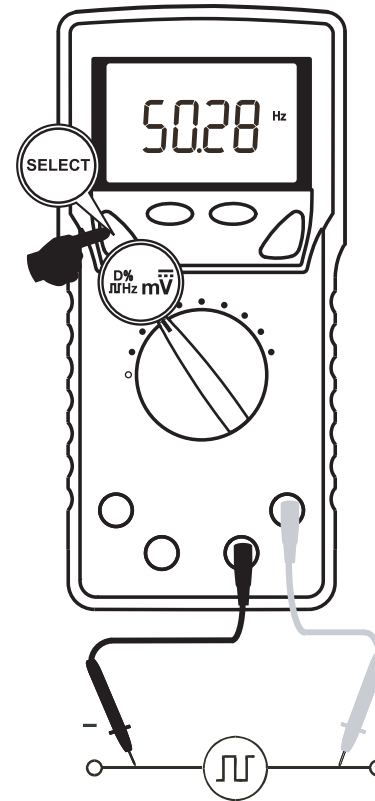

μD%

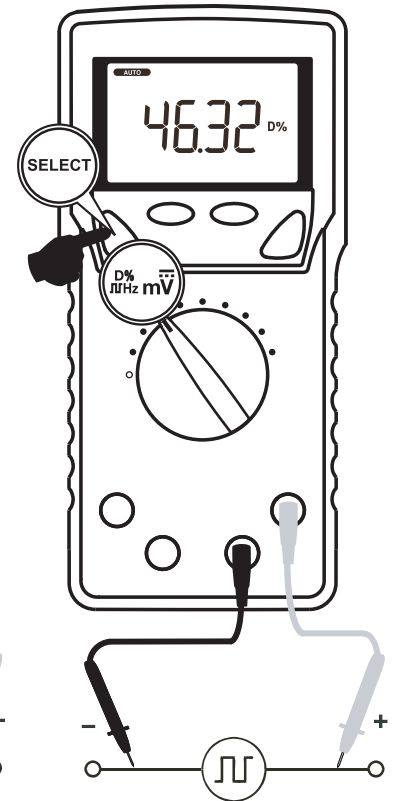

**Note:**

- The display style of [mV̄ / mV̂], [μHz], and [μD%] does not show the bar graph.

## 5-5 [Hz/mV] (Max. rated input voltage: 600mV dc/ac)

### • AC Voltage (mV) / Frequency (Hz) Simultaneous Measurement

#### ⚠ WARNING

1. Do not apply any input signal exceeding the max. rated input voltage.
2. Do not switch the function selector while measuring.
3. Keep your fingers behind the finger guards of the test leads while measurement.

#### 1) What to measure

- mV (AC voltage): AC voltage lower than 600mV
- Hz (Frequency): Frequency on a AC circuit lower than 600mV

#### 2) Measuring ranges

- mV: 60.00mV and 600.0mV
- Hz: 15.00Hz to 10.00kHz (Auto ranging)

#### 3) Measuring procedure

- ① Connect the red plug of the test lead to the VHz measuring terminal and the black one to the COM terminal.
- ② Set the function selector to Hz/mV.
- ③ Press the SELECT button to select a function you want to perform.
- ④ Apply the test pins (Red and Black) to the object to measure.
- ⑤ Read the display.

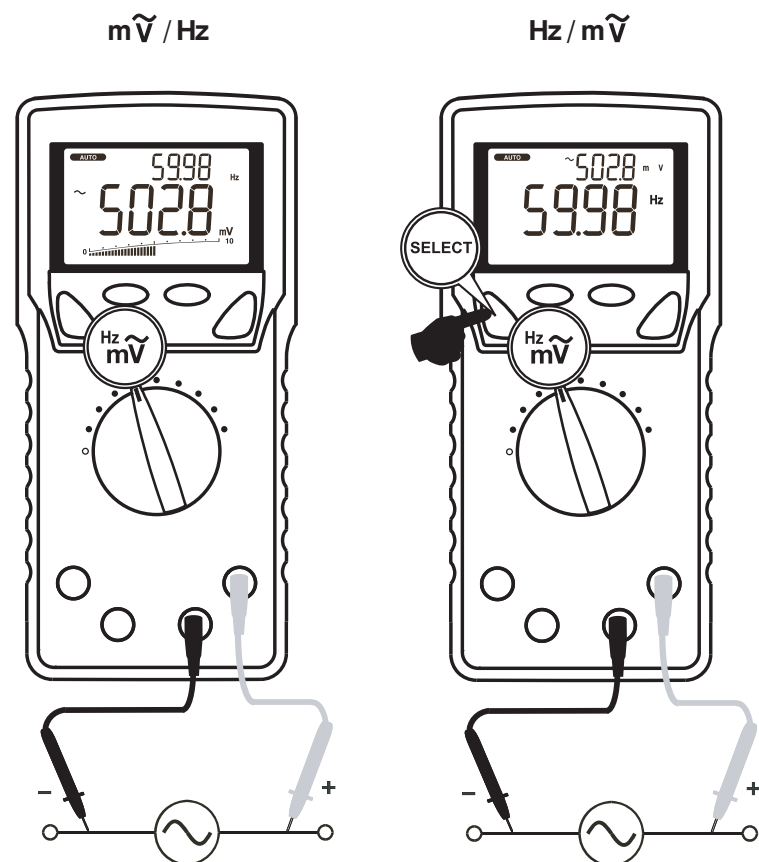

#### Note:

Range	Frequency measurement (Hz) Input sensitivity (Sine wave)	Frequency range
60.00mV	40mV	15.00Hz ~ 50.00kHz
600.0mV	60mV	

- The display style of [Hz/mV] does not show the bar graph.
- As a normal condition, non-connected test leads may cause unstable readings.

## 5-6 [Ω] (Do not apply any voltage or current.)

### • Resistance (Ω) measurement

#### ⚠ WARNING

Do not apply any voltage or current to the measuring terminals.

#### ⚠ CAUTION

In the case of high resistance measurement, readings may be unstable due to external inductive influence.

#### 1) What to measure

- Ω(Resistance): Resistor, circuit resistance, etc.

#### 2) Measuring ranges

- Ω: 6 ranges; 600.0Ω, 6.000kΩ, 60.00kΩ, 600.0kΩ, 6.000MΩ, and 60.00MΩ

\*Open circuit voltage between the measuring terminals: <1.2V dc (<1.0V dc for 60.00MΩ range)

#### 3) Measuring procedure

- ① Connect the red plug of the test lead to Ω measuring terminal and the black one to the COM terminal.
- ② Set the function selector to Ω.
- ③ Apply the test pins (Red and Black) to the object to measure.
- ④ Read the display.

Ω

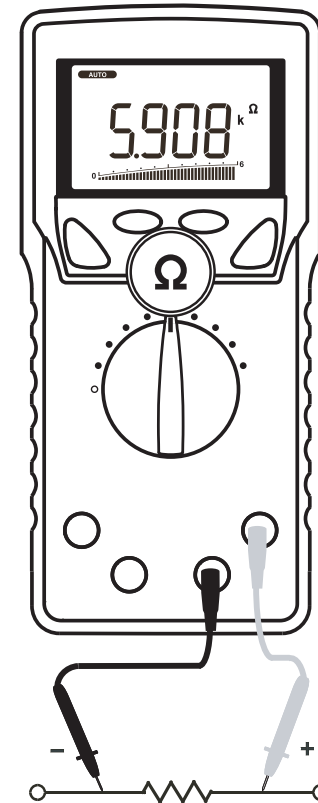

#### Note:

To avoid external noise influence, shield the object to measure with COM potential. Measurements with finger-touched test pins may cause some errors being influenced by human body conductance.

## 5-7 [•••)] (Do not apply any voltage or current.)

### • Continuity Check (•••)]

#### ⚠ WARNING

Do not apply any voltage or current to the measuring terminals.

#### ⚠ CAUTION

In the case of high resistance measurement, readings may be unstable due to external inductive influence.

#### 1) What to measure

- •••)](Continuity check): Wiring connections, Operation of switches, etc.

#### 2) Measuring ranges

- •••)] :Beeper threshold level: between 20Ω and 300Ω  
Response time: <100μs

\*Open circuit voltage between the measuring terminals: <1.2V dc

#### 3) Measuring procedure

- ① Connect the red plug of the test lead to ••••)] measuring terminal and the black one to the COM terminal.
- ② Set the function selector to ••••)].
- ③ Apply the test pins (Red and Black) to the object to measure.
- ④ A continuous beep tone indicates a complete wire.  
(The LCD display indicates the measured resistance at the time.)

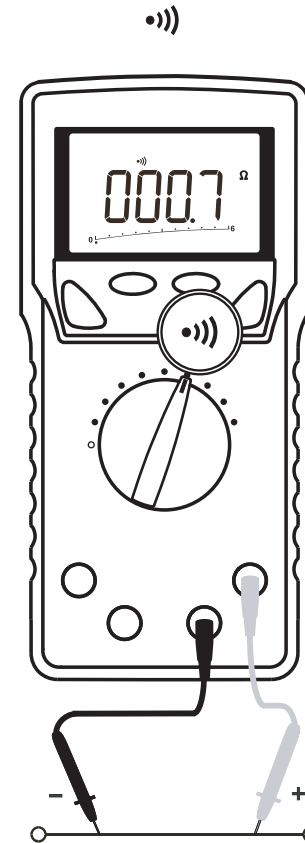

#### Note:

To avoid external noise influence, shield the object to measure with COM potential. Measurements with finger-touched test pins may cause some errors being influenced by human body conductance.



5-8 [⎓→] (Do not apply any voltage or current.)

- Capacitance (⎓) measurement
- Diode (⎓→) test

**⚠ WARNING**

1. Do not apply any voltage or current to the measuring terminals.
2. Measuring live circuit may damage the meter.

5-8-1 Capacitance (⎓) measurement

**⚠ CAUTION**

1. Discharge the capacitor before any measurement.
2. The instrument applies the current to the capacitor to measure.  
Capacitors with large leakage such as chemical capacitors cannot be measured accurately.

1) What to measure

⎓ (Capacitance): Capacitance of capacitors

2) Measuring ranges

⎓: 7 ranges; 60.00nF, 600.0nF, 6.000μF, 60.00μF, 600.0μF, 6.000mF, and 25.00mF

3) Measuring procedure

- ① Connect the red plug of the test lead to ⎓ measuring terminal and the black one to the COM terminal.
- ② Set the function selector to ⎓→, then press the SELECT button to select the capacitance measurement. (Unit "F" will be indicated.)
- ③ Apply the test pins (Red and Black) to the object to measure.
- ④ Read the display.

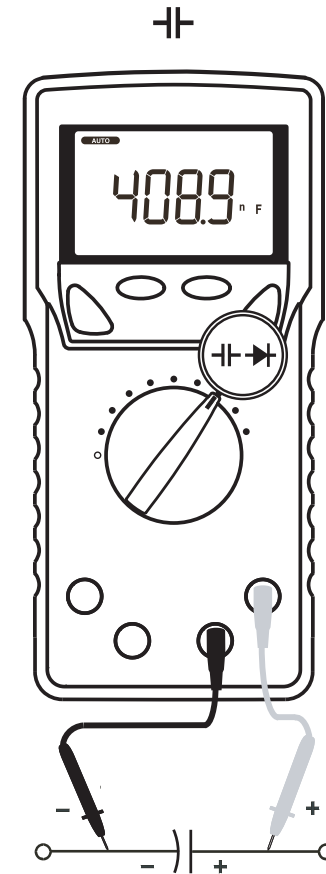

**Note:**

Capacitance function does not show the bar graph.

## 5-8-2 Diode (→|←) test

### 1) What to measure

→|← (Diode test): Judging the diode (Good or defective)

### 2) Measuring procedure

- ① Connect the red plug of the test lead to →|← measuring terminal and the black one to the COM terminal.
- ② Set the function selector to →|←, then press the SELECT button to select the diode test.  
(The sub display shows [diode].)
- ③ Apply the black test pin to the cathode of the diode, and the red to the anode.
- ④ The display will show the forward voltage drop (forward biased).

\*Forward biased voltage drop for a good silicon diode is between 0.400V to 0.900V. A reading higher than that indicates a defective diode. A zero (or close to) reading indicates a defective diode (shorted). An OL indicates a defective diode (open).

- ⑤ Apply the red test pin to the cathode of the diode, and the black one to the anode.

\*A reading [OL] for reverse biased voltage drop indicates the diode is good. Any other readings indicate the diode is defective (resistive or shorted).

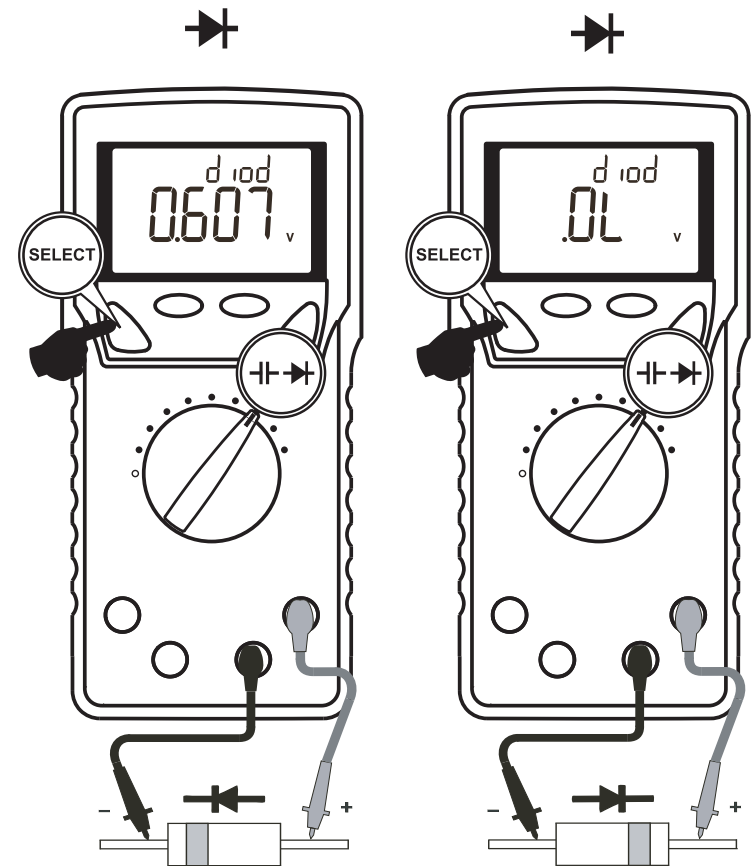

Forward biased test

Reverse biased test

### Note:

- Open circuit voltage between the measuring terminals: <3.5V dc
- Test current: 0.4mA (typical)
- Diode test function does not show the bar graph.

5-9  $\left[ \frac{A}{mA \sim Hz} \right]$  ,  $\left[ \frac{\mu A}{\mu A \sim Hz} \right]$

- DC current ( $\bar{m}\bar{A}$ ,  $\bar{\mu}\bar{A}$ ,  $\bar{A}$ ) measurement
- AC current ( $\tilde{m}\tilde{A}$ ,  $\tilde{\mu}\tilde{A}$ ,  $\tilde{A}$ )/Frequency(Hz) simultaneous measurement
- DC current ( $\bar{m}\bar{A}$ ,  $\bar{\mu}\bar{A}$ ,  $\bar{A}$ )/AC current ( $\tilde{m}\tilde{A}$ ,  $\tilde{\mu}\tilde{A}$ ,  $\tilde{A}$ ) simultaneous measurement

**⚠ WARNING**

1. Do not apply any voltage to the measuring terminals.
2. Be sure to connect the meter in series with the load object.
3. Do not apply any input exceeding the max. rated current.
4. First turn off the circuit to measure, then cut the part. Connect the test leads of the meter properly in series with the circuit.

**Correct way**

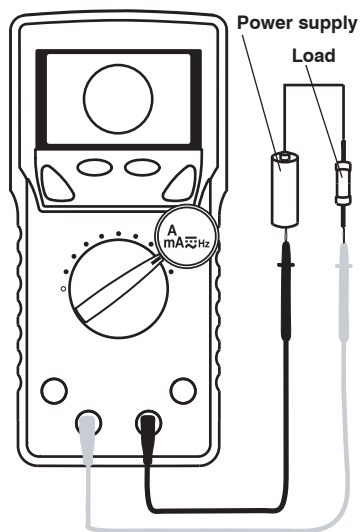

**Wrong way**

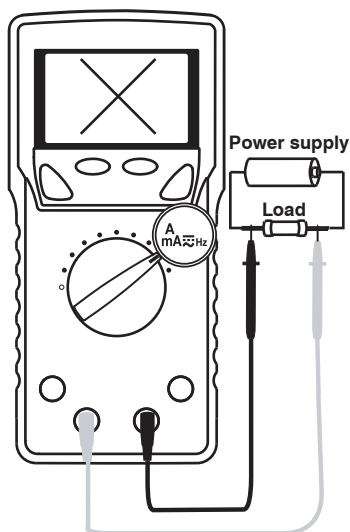

**5-9-1 Current (mA/μA) measurement**

( $\bar{m}\bar{A}$ ,  $\tilde{m}\tilde{A}$ ,  $\bar{\mu}\bar{A}$ ,  $\tilde{\mu}\tilde{A}$  Max. rated input current 600mA dc/ac)

1) What to measure

- $\bar{m}\bar{A}$ ,  $\bar{\mu}\bar{A}$  (DC current): DC circuit current
- $\tilde{m}\tilde{A}$ ,  $\tilde{\mu}\tilde{A}$  (AC current): AC circuit current
- $\bar{m}\bar{A}/\tilde{m}\tilde{A}$ ,  $\bar{\mu}\bar{A}/\tilde{\mu}\tilde{A}$  (DC current component/AC current component)
- Hz (Frequency): Measuring current frequency

2) Measuring ranges

**mA** : 2 ranges; 60.00mA and 600.0mA

**μA** : 2 ranges; 600.0μA and 6000μA

3) Measuring procedure

- ① Set the function selector to  $\frac{A}{mA \sim Hz}$  or  $\frac{\mu A}{\mu A \sim Hz}$  , then press the SELECT button to select [ $\bar{m}\bar{A}$  ], [ $\bar{m}\bar{A}/\tilde{m}\tilde{A}$  ], [ $\tilde{m}\tilde{A}/Hz$  ] for mA range , or select [ $\bar{\mu}\bar{A}$  ], [ $\bar{\mu}\bar{A}/\tilde{\mu}\tilde{A}$  ], [ $\tilde{\mu}\tilde{A}/Hz$  ] for μA range.
- ② Connect the red plug of the test lead to **mA μA** measuring terminal and the black one to the COM terminal.
- ③ Connect the test pins (red and black) in series with the circuit to measure.
  - $\bar{m}\bar{A}, \bar{\mu}\bar{A}$  : Connect the black test pin to the lower electric potential side of the circuit to measure, and the red test pin to the higher electric potential side in series with the object.
  - $\tilde{m}\tilde{A}/\tilde{\mu}\tilde{A}$  : Connect the test pins (red and black) in series with the circuit to measure.
- ④ Read the display.

Note:

Measuring Range	Frequency (Hz) Input sensitivity(Sine wave)	Frequency range
600.0 $\mu$ A	60 $\mu$ A	15.00Hz ~ 3.000kHz
6000 $\mu$ A	600 $\mu$ A	
60.00mA	40mA	
600.0mA	60mA	

### 5-9-2 Current (A) measurement

( $\overline{\text{A}}$ ,  $\tilde{\text{A}}$  Max. rated input current AC 10A dc/ac )

#### 1) What to measure

- $\overline{\text{A}}$  (DC current): DC circuit current
- $\tilde{\text{A}}$  (AC current): AC circuit current
- $\overline{\text{A}}\tilde{\text{A}}$  (DC current component / AC current component)
- Hz (Frequency): Measuring current frequency

#### 2) Measuring ranges

6.000A and 10.00A

#### 3) Measuring procedure

- ① Set the function selector to  $\overline{\text{A}}$ ,  $\tilde{\text{A}}$ , or  $\overline{\text{A}}\tilde{\text{A}}$ , and press the SELECT button to select a display style from  $[\overline{\text{A}}]$ ,  $[\overline{\text{A}}/\tilde{\text{A}}]$ , and  $[\tilde{\text{A}}/\text{Hz}]$ .
- ② Connect the red plug of the test lead to **A** measuring terminal and the black one to the COM terminal.
- ③ Connect the test pins (red and black) in series with the circuit to measure.
  - $\overline{\text{A}}$ : Connect the black test pin to the lower electric potential side of the circuit to measure, and the red test pin to the higher electric potential side in series with the object.
  - $\tilde{\text{A}}$ : Connect the test pins (red and black) in series with the circuit to measure.
- ④ Read the display.

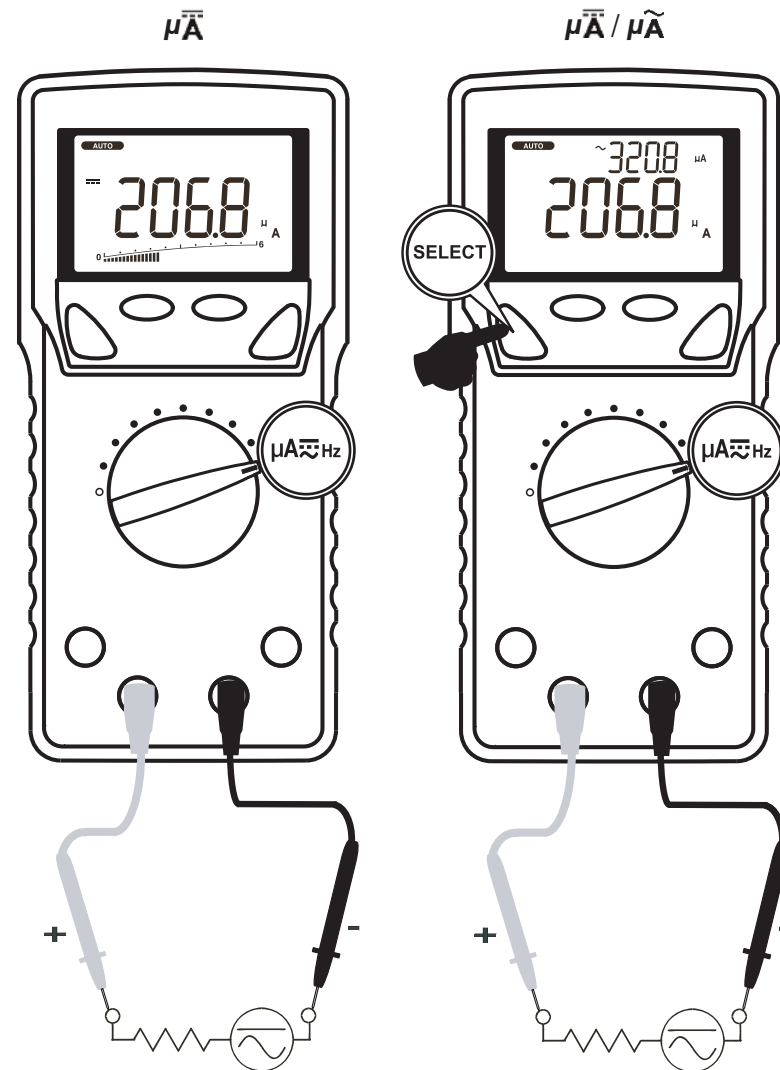

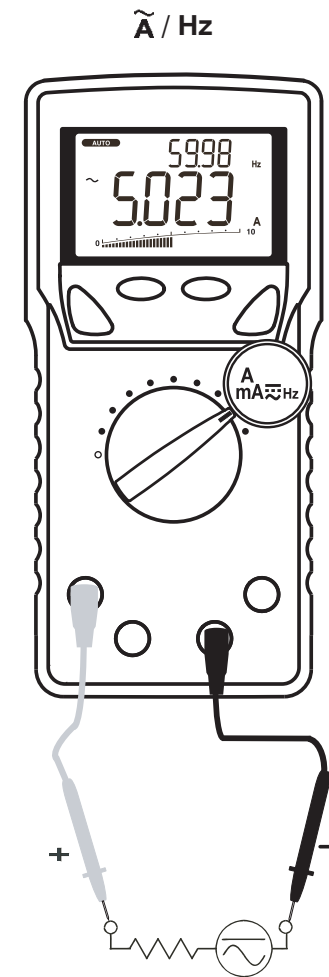
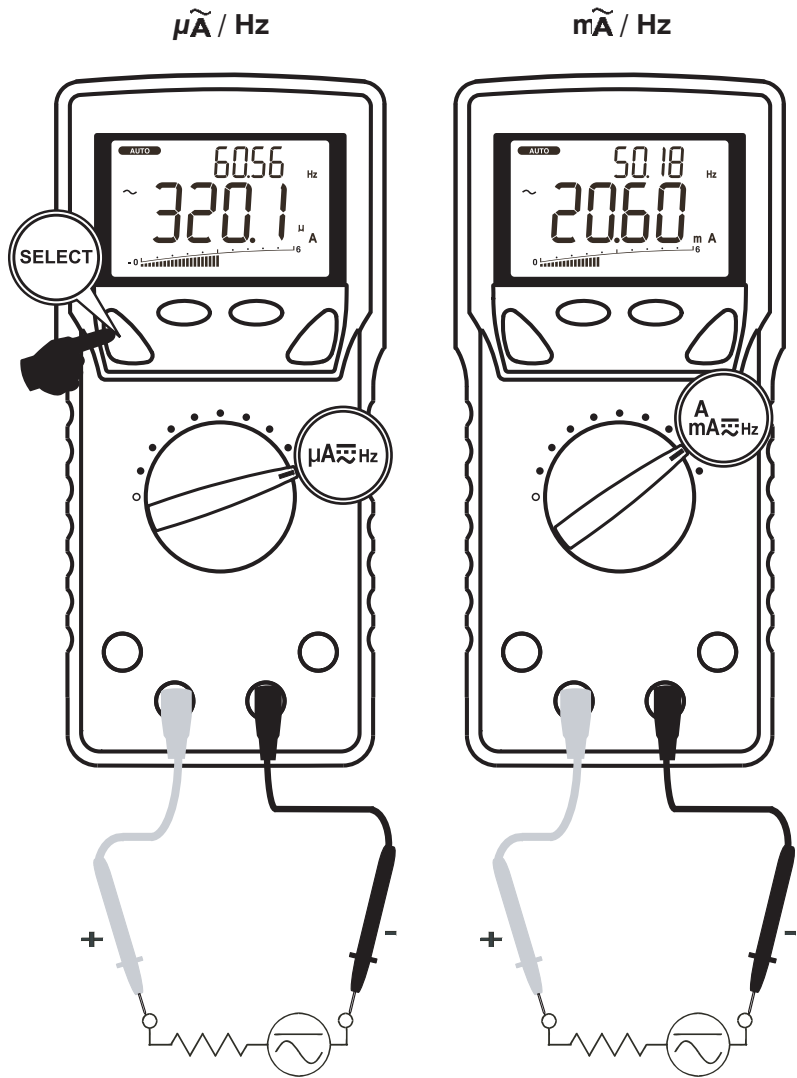

Note:

- > 6A: Cool down more than 3 minutes after measuring 1 minute.
- < 6A Continuable

Measuring range	Frequency (Hz) Input sensitivity (Sine wave)	Frequency range
6.000A	4A	15.00Hz ~ 3.000kHz
10.00A	7A	

## 5-10 Measurements with Separately Available Accessories

### ⚠ WARNING

1. Do not apply any input exceeding max. rated input for the separately available accessories.
2. Do not switch the function selector while measuring.

### ⚠ CAUTION

To make measurements of consumption current for home appliances using a current probe, use a line separator as shown in the drawing below.

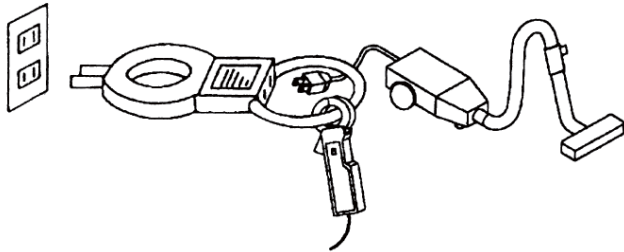

## 5-10-1 Clamp probe: CL-20D (Max. measurable current 200A ac)

- 1) What to measure  
50/60 Hz sine wave current such as consumption current of home appliances, current of power supply equipments, and etc.
- 2) Measuring ranges  
20A and 200A
- 3) Measuring procedure
  - ① Connect the red plug of the current probe to the V measuring terminal and the black one to the COM terminal.
  - ② Set the function selector to  $\text{Hz}\tilde{\text{V}}$ , then press the SELECT button to select  $\tilde{\text{V}}/\text{Hz}$ .
  - ③ Press the RANGE button to set the 9.999V range.
  - ④ Set the range selector knob on the current probe to the 20A range or 200A range.
  - ⑤ Open the clamp jaws of the clamp probe and clamp the wire to measure.
  - ⑥ Multiply the reading by 10 for 20A range, and by 100 for 200A range.

### Note:

- Current exceeding 20A or 200A cannot be measured. (Do not measure such high current even though the display works.)
- Try to put the wire to measure in the center of the clamp jaws as possible.

### 5-10-2 Clamp probe: CL-22AD

(Max. measurable current 200A dc/ac)

#### 1) What to measure

ACA: 50/60 Hz sine wave current such as consumption current of home appliances, current of power supply equipments, and etc.

DCA: Current of automotive electric circuits, consumption current of DC equipments, etc.

#### 2) Measuring ranges

20A and 200A

#### 3) Measuring procedure

① Connect the red plug of the current probe to the V measuring terminal and the black one to the COM terminal.

② To make DC current measurement (DCA), set the function selector to  $\frac{D}{mHz} m\bar{V}$  and press the SELECT button to select  $m\bar{V}$ , then press the RANGE button to set 600.0mV range.

To make AC current measurement (ACA), set the function selector to  $\frac{Hz}{m} \bar{V}$  and press the SELECT button to select  $m\bar{V}$  /Hz, then press the RANGE button to set 600.0mV range.

③ Set the range selector knob on the current probe to the 20A range or 200A range.

\*Before making DC current measurement, turn the Center Adjuster knob to make the reading zero.

④ Open the clamp jaws of the clamp probe and clamp the wire to measure.

⑤ Multiply the reading by 0.1 for 20A range, and read the display directly for 200A range.

#### Note:

- Current exceeding 20A or 200A cannot be measured.  
(Do not measure such high current even though the display works.)
- Try to put the wire to measure in the center of the clamp jaws as possible.

### 5-10-3 DC Clamp probe: CL-33D

(Max. measurable current 300A dc)

#### 1) What to measure

Current of automotive electric circuits, consumption current of DC equipments, etc.

#### 2) Measuring ranges

30A and 300A

#### 3) Measuring procedure

① Connect the red plug of the current probe to the V measuring terminal and the black one to the COM terminal.

② Set the function selector to  $\frac{D}{mHz} m\bar{V}$  and press the SELECT button to select  $m\bar{V}$ , then press the RANGE button to set 600.0mV range.

③ Set the range selector knob on the current probe to the 30A range or 300A range.

\*Before making DC current measurement, turn the Center Adjuster knob to make the reading zero.

④ Open the clamp jaws of the clamp probe and clamp the wire to measure.

⑤ Multiply the reading by 0.1 for 30A range, and read the display directly for 300A range.

#### Note:

- Current exceeding 30A or 300A cannot be measured.  
(Do not measure such high current even though the display works.)
- Try to put the wire to measure in the center of the clamp jaws as possible.

#### 5-10-4 Temperature probe: T-300PC

##### 1) What to measure

Temperature of liquid, solids, gas, and etc.

Note:

To make temperature measurement, connect the temperature probe to the PC700 connected to the PC on which sanwa's software PC Link7 is installed and running.

##### 2) Measuring range

-50 ~ 300 °C

DMM range: 6kΩ

##### 3) Measuring procedure

- ① Connect the red plug of the temperature probe to  $\Omega$  measuring terminal and the black one to the COM terminal.
- ② Set the function selector to  $\Omega$ .
- ③ Press the RANGE HOLD button to set 6kΩ.
- ④ Apply the thermocouple to the object to measure.
- ⑤ Read the measurements on the information window of the PC Link7.
- ⑥ Remove the thermocouple from the object.

## [6] MAINTENANCE

### WARNING

1. The followings are important to safety. Read this manual thoroughly to maintain the instrument.
2. Calibrate and inspect the instrument at least once a year to ensure safety and maintain its accuracy.

#### 6-1 Simple Examination

##### 1) Appearance

- Check for damaged appearance by dropping down and so on.

##### 2) Test leads

- Check for loose contacts between the measuring terminals and test lead plugs.
- Check for damaged test lead wires.
- Check for exposed core wire anywhere on the test leads.

If you find any problem on the above items, stop using immediately and ask us to repair it.

Check for the test leads without breaking wires, referring to the section 5-1.

#### 6-2 Calibration

If self-diagnostic message “rE-O” is being displayed while powering on, the meter is re-organizing internal parameters. Do not turn off the meter, and it will be back to normal measurement shortly. However, if self-diagnostic message “C\_Er” is being displayed while powering on, some meter ranges might be largely out of specifications. To avoid misleading measurements, stop using the meter and send it for re-calibration. Refer to the AFTER-SALE SERVICE section for obtaining warranty or repairing service.

For requesting calibration and inspection, contact an authorized agent/distribution service provider, listed in our website. See section 7-3.



## 6-3 Battery and Fuse Replacement

### **⚠ WARNING**

1. Do not open the rear case with live measuring terminals to avoid electric shock. Also, make sure the meter power is OFF, before starting replacement.
2. Be sure to use the specified fuse. Neither use unspecified fuse nor short-circuit the fuse holder.

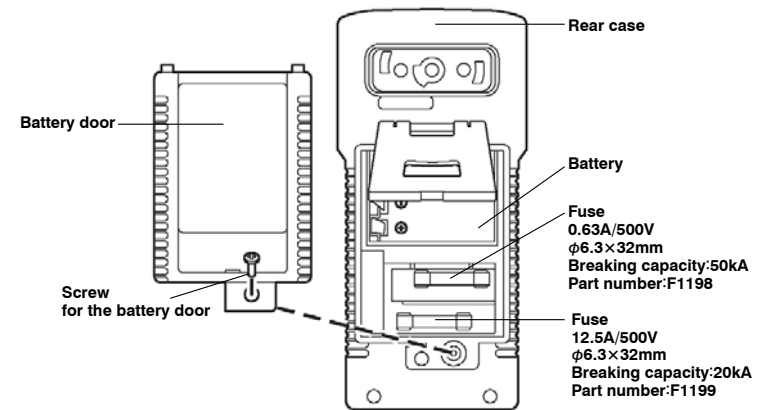

### **Pre-installed battery**

Since the pre-installed battery is for monitoring, it may not be durable as typically expected.

\*The purpose of the battery for monitoring is to check for the functions and performances of the product.

### **Replacement procedure**

- ① Remove the holster and loosen the Philips-head screw fixing the battery door using appropriate screw driver.
- ② Remove the battery door and replace the battery or fuse with new one.
- ③ Re-fasten the screw and set the holster again.

## 6-4 Storage

### **⚠ CAUTION**

1. The panel and case are not resistant to volatile solvents. Do not wipe out with solvents or isopropyl alcohol. Clean the instrument up with a dry soft cloth.
2. The panel and case are not resistant to heat. Keep it away from heat-generating devices such as solder irons.
3. Do not save the instrument into vibratory places or where the instrument may fall off.
4. Do not expose the instrument to direct sunlight and do not save it into any places with extreme temperature, humid, or condensation.
5. Remove the battery for saving the instrument over a long period of time.

Save the instrument into an appropriate place, according to the precautions above.

## [7] AFTER-SALE SERVICE

### 7-1 Warranty and Provision

Sanwa offers comprehensive warranty services to its end-users and to its product resellers. Under Sanwa's general warranty policy, each instrument is warranted to be free from defects in workmanship or material under normal use for the period of one (1) year from the date of purchase.

This warranty policy is valid within the country of purchase only, and applied only to the product purchased from Sanwa authorized agent or distributor.

Sanwa reserves the right to inspect all warranty claims to determine the extent to which the warranty policy shall apply. This warranty shall not apply to disposables batteries, or any product or parts, which have been subject to one of the following causes:

1. A failure due to improper handling or use that deviates from the instruction manual.
2. A failure due to inadequate repair or modification by people other than Sanwa service personnel.
3. A failure due to causes not attributable to this product such as fire, flood and other natural disaster.
4. Non-operation due to a discharged battery.
5. A failure or damage due to transportation, relocation or dropping after the purchase.

### 7-2 Repair

Customers are asked to provide the following information when requesting services:

1. Customer name, address, and contact information
2. Description of problem
3. Description of product configuration
4. Model Number
5. Product Serial Number
6. Proof of Date-of-Purchase
7. Where you purchased the product

Please contact Sanwa authorized agent / distributor / service

provider, listed in our website, in your country with above information. An instrument sent to Sanwa / agent / distributor without above information will be returned to the customer.

#### Note:

- 1) Prior to requesting repair, please check the following:  
Capacity of the built-in battery, polarity of installation and discontinuity of the test leads.
- 2) Repair during the warranty period:  
The failed meter will be repaired in accordance with the conditions stipulated in 7-1 Warranty and Provision.
- 3) Repair after the warranty period has expired:  
In some cases, repair and transportation cost may become higher than the price of the product. Please contact Sanwa authorized agent / service provider in advance.  
The minimum retention period of service functional parts is 6 years after the discontinuation of manufacture. This retention period is the repair warranty period. Please note, however, if such functional parts become unavailable for reasons of discontinuation of manufacture, etc., the retention period may become shorter accordingly.
- 4) Precautions when sending the product to be repaired:  
To ensure the safety of the product during transportation, place the product in a box that is larger than the product 5 times or more in volume and fill cushion materials fully and then clearly mark "Repair Product Enclosed" on the box surface. The cost of sending and returning the product shall be borne by the customer.

### 7-3 SANWA web site

<http://www.sanwa-meter.co.jp>

E-mail: [exp\\_sales@sanwa-meter.co.jp](mailto:exp_sales@sanwa-meter.co.jp)

## [8] SPECIFICATIONS

### 8-1 General Specifications

Operation method	Delta-sigma modulation	
LCD display	Main display	9,999 counts: DCV, ACV, Logic-Level Frequency(Hz), and Duty Cycle 6,000 counts: DCmV, ACmV, Resistance, Continuity, Capacitance, DCA, DCmA, DC $\mu$ A, ACA, ACmA, and AC $\mu$ A 2,000 counts: Diode Bar graph: Up to 41 segments
	Sub display	9,999 counts: ACV, Frequency (Hz) 6,000 counts: ACmV, ACA, ACmA, and AC $\mu$ A
Over-range indication	Over-range input turns on "OL" indicator at the numeric part.	
Sampling rate	Numeric part	5 times / sec.
	Bar graph part	60 times / sec.
Low battery indication	Decreasing the internal battery voltage to approx. 7V turns the battery mark on.	
Operating conditions	Altitude: < 2,000m Pollution degree: II	
Operating temperature/humidity	5°C to 40°C : non-condensing 5°C to 31°C : 80%RH (Max.) 31°C to 40°C : decreasing 80% to 50% linearly	
Storage temperature/humidity	-10°C to 40°C : 80%RH (Max.) non-condensing (with battery removed) 40°C to 50°C : 70%RH (Max.) non-condensing (Remove the battery, if the equipment is not going to be used for a long time.)	
Temperature coefficient	0.15 x (accuracy @23±5°C) / °C @(0°C to 18°C or 28°C to 40°C)	
Power source	Single manganese 9V battery 6LR61 (IEC6LF22, NEDA1604A)	
AC sensing method	Average sensing RMS calibrated	

Auto Power Saving	Approx. 30 minutes after the last operation	
Safety Compliances	IEC61010-1:2001 IEC61010-031:2008	
		Category II for 1000V ac and dc Category III for 600V ac and dc
	<b>mA<math>\mu</math>A</b>	Category II for 500V ac and dc Category III for 300V ac and dc
	<b>A</b>	Category II for 500Vac and 300Vdc Category III for 300Vac and 150Vdc
EMC	Meets EN61326-1:2006 In an RF field of 3V/m: Capacitance function is not specified. Other function ranges: Total Accuracy = $\pm$ (Specified% rdg + 100digits) Performance above 3V/m is not specified.	
Dimensions	without holster	Approx. L175mm×W80mm×H40mm
	with holster	Approx. L184mm×W86mm×H52mm
Weight	without holster	Approx. 360g
	with holster	Approx. 430g
Power consumption	Approx. 48mW / approx. 0.45mW (Auto Power Saving)	
Battery life	Approx. 60hours (DCV measurement)	
Accessories	Test leads (TL-23a), Holster (H-700) with light shielding magnet cap, Instruction manual	

### OVERVOLTAGE CATEGORY

- Equipment of CAT I: Secondary cable runs from a power supply transformer connected to a wall socket.
- Equipment of CAT II: Primary cable runs of power-consuming equipments from a wall socket.
- Equipment of CAT III: Primary cable runs of equipments directly connected to a distribution board and cable runs from a distribution board to wall sockets.
- Equipment of CAT IV: Cable runs from an incoming line to a distribution board.

## 8-2 Measuring Range and Accuracy

Accuracy:  $\pm$ (% rdg + dgt)

rdg: reading, dgt: least significant digit

Temperature: 23 °C  $\pm$ 5 °C , Humidity: <75% R.H.

True RMS voltage and current accuracies are specified from 10% to 100% of each range otherwise specified.

Crest factor: <2:1 (at full scale), <4:1 (at half scale)

### DC Voltage DCV

DC voltage (DCV) for single display

Range	Accuracy
60.00 mV	$\pm$ (0.12% rdg + 2dgt)
600.0 mV	$\pm$ (0.06% rdg + 2dgt)
9.999V, 99.99V, 999.9V	$\pm$ (0.08% rdg + 2dgt)

DC/AC Voltage (DC/AC V) for dual display

Range	Accuracy
60.00mV, 600.0mV 9.999V, 99.99V, 999.9V	$\pm$ (0.7% rdg + 6dgt)

Input impedance: 10M $\Omega$ , 80pF nominal

(130pF nominal for 600.0mV&60.00mV range)

### AC Voltage ACV

AC voltage (ACV)/ Frequency (Hz) for dual display

Range	Accuracy
50Hz ~ 60Hz	
60.00mV, 600.0mV, 9.999V, 99.99V, 999.9V	$\pm$ (0.5% rdg + 3dgt)
40Hz ~ 500Hz	
60.00mV, 600.0mV	$\pm$ (0.8% rdg + 4dgt)
9.999V, 99.99V	$\pm$ (1.0% rdg + 4dgt)
999.9V	$\pm$ (2.0% rdg + 4dgt)
500Hz ~ 1kHz	
60.00mV, 600.0mV	$\pm$ (2.0% rdg + 3dgt)
9.999V, 99.99V	$\pm$ (1.0% rdg + 4dgt)
999.9V	$\pm$ (2.0% rdg + 4dgt)
1kHz ~ 3kHz	
60.00mV, 600.0mV	$\pm$ (2.0% rdg + 3dgt)
9.999V, 99.99V, 999.9V	$\pm$ (3.0% rdg + 4dgt)
3kHz ~ 20kHz	
60.00mV, 600.0mV	$\pm$ (2.0% rdg + 3dgt)
9.999V *, 99.99V	$\pm$ 3dB
999.9V	Unspecified

Input impedance: 10M $\Omega$ , 80pF nominal

(130pF nominal for 600.0mV&60.00mV range)

Residual reading: Less than 5 digits with test leads shorted

\* 3kHz to 15kHz

### DC/AC Voltage (DC/AC V) for dual display

Range	Accuracy
50Hz ~ 60Hz	
60.00mV, 600.0mV	± (0.7% rdg + 6dgt)
9.999V, 99.99V, 999.9	
40Hz ~ 1kHz	
60.00mV, 600.0mV	± (1.0% rdg + 6dgt)
9.999V, 99.99V, 999.9V	± (2.2% rdg + 6dgt)
1kHz ~ 20kHz	
60.00mV, 600.0mV	± (2.2% rdg + 6dgt)
9.999V <sup>1)</sup> , 99.99V	±3dB
999.9V	Un specified

Input impedance: 10MΩ, 80pF nominal

(130pF nominal for 600.0mV&60.00mV range)

1) 3kHz ~ 15kHz

### DC current (DCA)

Range	Accuracy	Input resistance**
600.0μA	± (0.2% rdg + 4dgt)	Approx. 83 Ω
6000μA		
60.00mA		Approx. 1 Ω
600.0mA		
6.000A		
10.00A*	Approx. 0.005 Ω	

\* > 6A: Cool down more than 3 minutes after measuring 1 minute.

< 6A Continuable

\*\*Fusing resistor not included

### AC current (ACA), DC/AC current (DC/AC A)

Range	Accuracy	Input resistance**
DC, 50Hz to 60Hz		
600.0μA	± (0.6% rdg + 3dgt)	Approx. 83 Ω
6000μA		
60.00mA	± (1.0% rdg + 3dgt)	Approx. 1 Ω
600.0mA		
6.000A 10.00A*	± (0.8% rdg + 6dgt)	Approx. 0.05 Ω
40Hz to 1kHz		
600.0μA 6000μA	± (0.8% rdg + 4dgt)	Approx. 83 Ω
60.00mA		
600.0mA	± (1.0% rdg + 4dgt)	Approx. 1 Ω
6.000A 10.00A*	± (0.8% rdg + 6dgt)	Approx. 0.005 Ω

\* > 6A: Cool down more than 3 minutes after measuring 1 minute.

< 6A Continuable

\*\*Fusing resistor not included

## Resistance ( $\Omega$ )

Range	Accuracy
600.0 $\Omega$ , 6.000k $\Omega$ , 60.00k $\Omega$ , 600.0k $\Omega$	0.1% rdg + 3dgt
6.000M $\Omega$	0.4% rdg + 3dgt
60.00M $\Omega$	1.5% rdg + 5dgt

Open circuit voltage: <1.2Vdc (<1.0Vdc for 60.00M $\Omega$  range)

## Frequency (Hz)

Measuring ranges	Input sensitivity*	Frequency ranges
60.00mV	40mV	15.00Hz to 50.00kHz
600.0mV	60mV	
9.999V	2.5V	15.00Hz to 10.00kHz
99.99V	25V	
999.9V	100V	
600.0 $\mu$ A	60 $\mu$ A	15.00Hz to 3.000kHz
6000 $\mu$ A	600 $\mu$ A	
60.00mA	40mA	
600.0mA	60mA	
6.000A	4A	
10.00A	7A	

Accuracy:  $\pm(0.04\% \text{ rdg} + 4\text{dgt})$

\*Specified based on sine wave RMS

## Logic level frequency ( $\mu$ Hz ) and Duty cycle (D%)

DCmV function	Range	Accuracy*
Frequency	5.000Hz ~ 1.000MHz	$\pm (0.03\% \text{rdg} + 4\text{dgt})$
Duty cycle	0.00% ~ 100.0%	$\pm (3\text{dgt}/\text{kHz} + 2\text{dgt})$ **

\* Input sensitivity: Square wave more than 2.5V  
(3V and 5V logic family)

\*\* Specified Frequency: 5Hz to 10kHz

## Capacitance $\text{--}\text{||}\text{--}$

Range	Accuracy*
60.00nF, 600.0nF***	$\pm (0.8\% \text{rdg} + 3\text{dgt})$
6.000 $\mu$ F	$\pm (1.0\% \text{rdg} + 3\text{dgt})$
60.00 $\mu$ F	$\pm (2.0\% \text{rdg} + 3\text{dgt})$
600.0 $\mu$ F **	$\pm (3.5\% \text{rdg} + 5\text{dgt})$
6.000mF **	$\pm (5.0\% \text{rdg} + 5\text{dgt})$
25.00mF **	$\pm (6.5\% \text{rdg} + 5\text{dgt})$

\* Accuracies with film capacitor or better

\*\* In manual-ranging mode, measurements not specified below 50.0 $\mu$ F, 0.54mF and 5.4mF for 600.0 $\mu$ F, 6.000mF and 25.00mF ranges respectively

\*\*\* In manual-ranging mode, the accuracy for measurements below 5.4nF for 60.00nF range and 54nF for 600.0nF range is:  $\pm(0.8\% \text{rdg} + 6\text{dgt})$

## Diode test $\rightarrow\text{||}\leftarrow$

Range	Accuracy	Test current	Open circuit voltage
2.000V	$\pm (1\% \text{rdg} + 1\text{dgt})$	Approx. 0.4mA	< 3.5 V

## Continuity check $\bullet\text{||}\bullet$ )

Threshold level: 20 $\Omega$  to 300 $\Omega$

Response time: < 100 $\mu$ s

## How to calculate an accuracy

Example) DC voltage measurement (DC mV)

True value: 100.0 [mV]

Range accuracy:  $\pm(0.06\% \text{rdg} + 2\text{dgt})$  in the 600.0mV range

Measuring error:  $\pm(100.0 \text{ [mV]} \times 0.06\% \text{rdg} + 2\text{dgt})$

$\doteq \pm 0.3 \text{ [mV]}$

Calculation: 100.0 [mV]  $\pm 0.3 \text{ [mV]}$

Reading: 099.7 [mV] to 100.3 [mV]

\* 2dgt in the 600.0mV range corresponds to 0.2mV.

The product specifications and its appearance described in this manual are subject to change without prior notice for improvements or other reasons.

# SANWA®

## 三和電気計器株式会社

本社=東京都千代田区外神田2-4-4・電波ビル  
郵便番号=101-0021・電話=東京(03) 3253-4871(代)  
大阪営業所=大阪市浪速区恵美須西2-7-2  
郵便番号=556-0003・電話=大阪(06) 6631-7361(代)  
SANWA ELECTRIC INSTRUMENT CO.,LTD.  
Dempa Bldg., 4-4 Sotokanda2-Chome Chiyoda-Ku,Tokyo,Japan



This manual employs soy ink.

02-1109 5008 6010