

SANWA®



PC720M

DIGITAL MULTIMETER

INSTRUCTION MANUAL



Table of Contents

[1] SAFETY PRECAUTIONS	
1-1 Explanation of Warning Symbols	1
1-2 Warning Instructions for Safe Use	2
1-3 Overload Protection	3
[2] APPLICATIONS AND FEATURES	
2-1 Applications	4
2-2 Features	4
[3] Parts Identification	
3-1 Multimeter and Test Leads	5
3-2 Display	7
[4] DESCRIPTION OF FUNCTIONS	
4-1 Power Switch/Function Selector	8
4-2 Auto Power Saving	8
4-3 Low Battery Indication	9
4-4 Measuring Function Selection	9
4-5 Range Hold	10
4-6 (DH) Data Hold.....	10
4-7 Beeper Control	11
4-8 PC (Personal Computer) Interface	11
4-9 Data Logging (Recording)	12
4-10 Test Leads Improper Connection Warning	19
4-11 (CAPTURE) Crest capture mode (Sampling time: 1ms)	20
4-12 (REC) MAX/MIN Recording Mode	20
4-13 Δ Relative Measurement	20
4-14 Back Light	20
4-15 Terms	21
[5] Measuring procedures	
5-1 Pre-operational Check	22
5-2 Automatic measurement for $\Omega \cdot V$ under Low Impedance	24
5-3 AC Voltage (\tilde{V}) / Frequency (Hz) Measurement	27
5-4 DC voltage (\bar{V})/AC Voltage (\tilde{V})/DC+AC Voltage ($\tilde{\bar{V}}$) Measurement	30

5-5 DC Voltage ($m\bar{V}$)/AC Voltage ($m\tilde{V}$)/DC+AC Voltage ($m\tilde{\bar{V}}$), Logic-Level Frequency (\square Hz) and Duty Cycle (\square D%) Measurement	33
5-6 AC Voltage ($m\tilde{V}$) / Frequency (Hz) Measurement	37
5-7 Resistance (Ω) Measurement, Continuity Check (\bullet)), and Conductance (nS) Measurement	39
5-8 Temperature Measurement	42
5-9 Capacitance (H) Measurement, Diode (\rightarrow) Test	46
5-10 DC Current (\bar{A})/AC Current (\tilde{A})/DC+AC Current ($\tilde{\bar{A}}$), AC Current (\tilde{A}) / Frequency (Hz) Measurement	50
5-11 Measurements with Separately Available Accessories	56
[6] MAINTENANCE	
6-1 Simple Examination	61
6-2 Calibration	61
6-3 Battery and Fuse Replacement	62
6-4 Storage	63
[7] AFTER-SALE SERVICE	
7-1 Warranty and Provision	64
7-2 Repair	64
7-3 SANWA web site	65
[8] SPECIFICATIONS	
8-1 General Specifications	66
8-2 Measuring Range and Accuracy	68

● Messages on the display

Messages	Description	What to do
InEr	Test leads improper connection warning (Malfunction when low battery)	See 4-10 (Page 19) See 4-3 (Page 9)
rE-O C_Er	Self-diagnostic	See 6-2 (Page 61)

[1] SAFETY PRECAUTIONS

***Before use, read the following safety precautions.**

This instruction manual explains how to use your digital multimeter PC720M. Before using, read through this manual to reduce the risk of fire, electric shock, and/or injury. And save it together with the product so that you can refer to the manual as necessary.

Use the instrument only as specified in this manual or the protection provided by the instrument may be impaired.

The instructions given under the headings of " ⚠ WARNING" and must be followed to prevent accidental burn and electric shock.

1-1 Explanation of Warning Symbols

The meanings of the symbols used in this manual and attached to the product are as follows.

⚠ :Extremely-important instructions for safe use

- WARNING identifies conditions and actions that could result in accidental burn and electric shock.
- CAUTION identifies conditions and actions that could cause damage the instrument.

⚡ :Do not touch! Possible high voltage.

⏚ :Ground

▶ :Diode

Hz:Frequency

⏏ :Fuse

•••):Beep

⏏Hz:Logic-Level Frequency

⏏:Direct Current(DC)

⏏:Capacitor

⏏%:Duty Cycle

~:Alternate Current (AC) nS: Nano-Siemens (Conductance)

Ω:Resistance LoZ:Low Input Impedance

Temp:Temperature □ : Double Insulation or Reinforced

☀:Back light

1-2 Warning Instructions for Safe Use

⚠ WARNING

1. Do not use the instrument if the meter or test leads look damaged.
2. Be sure to use the specified fuse.
Neither use unspecified fuse nor short-circuit the fuse holder.
3. Do not apply higher voltage or current than the max. ratings by each function. (See 1-3)
4. Use caution when working with voltages above 33 V ac rms, 46.7 V ac peak, or 70 V dc. These voltages pose a shock hazard.
5. Do not use the meter to measure lines that may have inductive voltage or surge voltage (e.g. motors) because the input voltage may exceed the maximum rated voltage.
6. Never operate the meter with the case or battery lid removed.
7. Remove test leads from the meter before opening the meter case for replacing the battery or fuse.
8. Never attempt to repair or modify the instrument, except for battery and fuse replacement.
9. Do not use any unspecified type of test leads.
10. Keep your fingers behind the finger guards of the test leads while measurement.
11. Connect the common test lead (Black) before you connect the live test lead (Red). Disconnect the live test lead first.
12. Make sure the function, range, and measuring terminals are properly set.
13. Do not switch the function, range, or the plugs to another while measurement.
14. Do not operate the meter when it is wet or with wet hands.

⚠ CAUTION

Incorrect measurement may be performed in a ferromagnetic or intense electric field near transformers, high-current circuits, and radio equipments.

1-3 Overload Protection

Function	Measuring Terminal	Max. Rated Input	Overload Protection
[Auto Ω·V]	 and COM	1000 V dc/ac	1100 Vrms
[Hz V], [V]		10 V dc/ac	
[D% Hz mV], [Hz mV]		△Do not apply any voltage or current.	
[Ω·V], [A]			
[Temp]	T1+and-	50 mV dc	0.4 A/1000 V Fuse Breaking capacity: 30 kA and 11 A/1000 V Fuse Breaking capacity: 20 kA
	T2+and-		
[μA Hz], [mA Hz]	mA μA and COM	600 mA dc/ac △Do not apply any voltage.	0.4 A/1000 V Fuse Breaking capacity: 30 kA
[A Hz]	A and COM	10 A dc/ac △Do not apply any voltage.	11 A/1000 V Fuse Breaking capacity: 20 kA

*The 0.4A fuse has a Time-Current Characteristic Curves projection of approaching infinity at 0.6 A. It has a fast acting characteristic of below 0.1 second at beyond 1.5 A. This protection characteristic matches this meter nicely.

[2]APPLICATIONS AND FEATURES

2-1 Applications

This instrument is a portable digital multimeter designed to measure light electric circuits. The instrument offers not only measurements for small communication equipments, home electric appliances, output from a wall socket, and many batteries, also circuit analyses with additional functions.

2-2 Features

- Compliant with IEC61010-1 CAT. III 600 V, CAT. II 1000 V, and safe design using fuses with large number of breaking capacity.
- 9999 count display (ACV, DCV, Hz, nS)
- Fast response display
(Numeric parts: 5 times/Sec. Bar graph part: 60 times/Sec.)
- Dual Display shows "Voltage or Current and its Frequency", and "AC components and DC components of Voltage or Current"
- True RMS detection for alternate current (AC) (True RMS)
- DC+AC indications available
- AutoΩ-V function recognizes automatically DCV, ACV, or Ω
- Maximum DC/AC voltage measurement resolution: 0.01 mV
- Frequency (Sensitivity selectable),
Wide capacitance range (0.01 nF to 25.00 mF)
- Automatically range selectable Crest Capture Mode
Sampling time: Approx. 1 ms
- MAX/MIN recording mode with auto ranging
- Relative mode with auto ranging
- Back light to allow for easy visibility in low-lit area
- 2 channel simultaneous temperature measurement
(K-type thermocouple: -50 °C to 1000 °C)
- Logging function to store up to 87,328 readings
(single display) or 43,664 readings (dual display)
- PCLink7 (separately available software) allows you to download logged data into your PC with USB optical communication unit (KB-USB7)

[3] Parts Identification

3-1 Multimeter and Test Leads

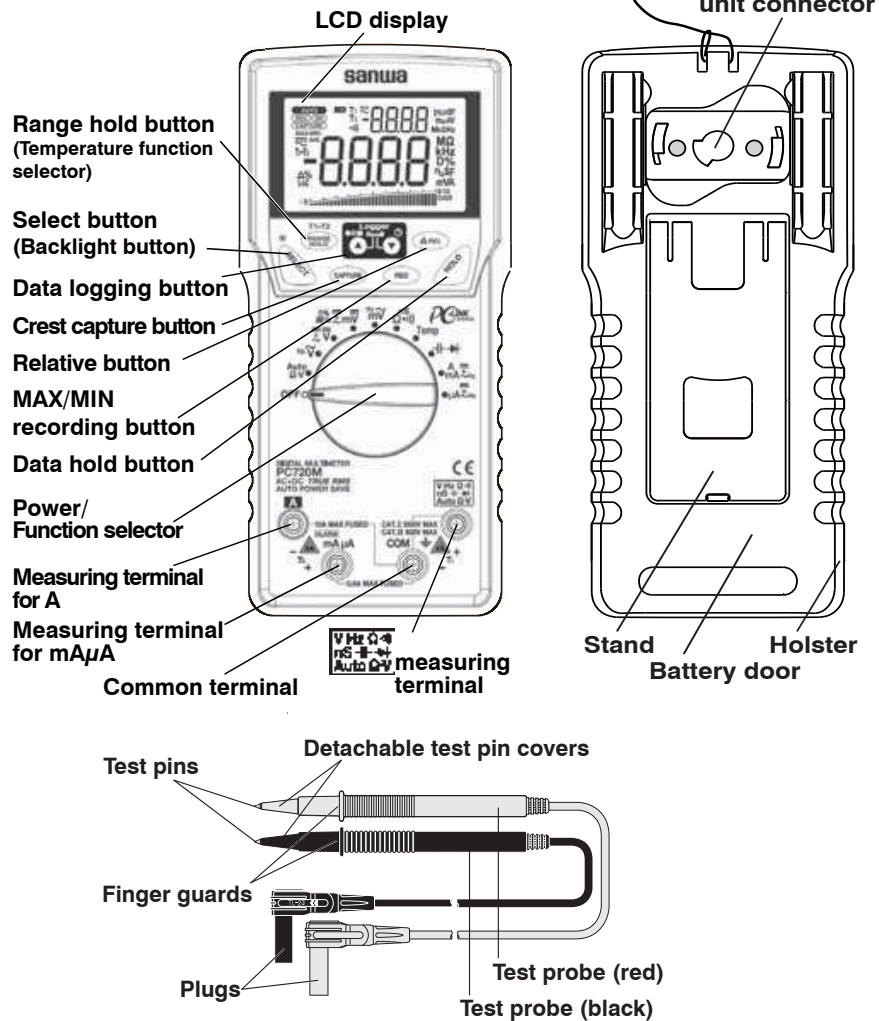

Test leads TL-23a

With the detachable test pin covers: CAT. III 600 V
 Without the detachable test pin covers: CAT. II 1000 V

How to detach the light shielding magnet cap

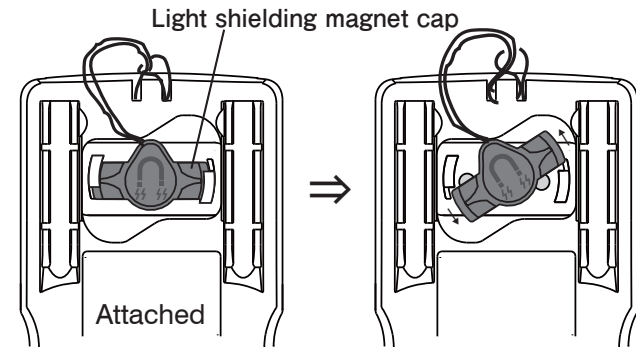

Turn the light shielding magnet cap counterclockwise to detach.

An application of the light shielding magnet cap

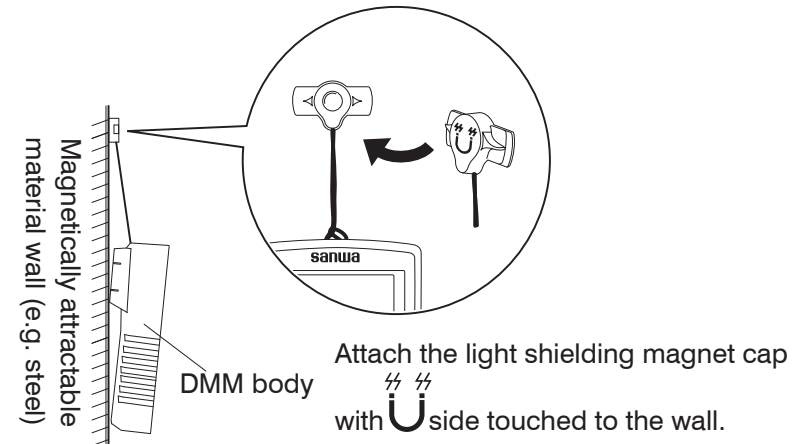

Note:

Keep the light shielding magnet cap away from cellular phones, analog watches, floppy disks, magnetic cards, magnetic tapes, and magnetic tickets. Otherwise, the memorized information may be lost.

3-2 Display

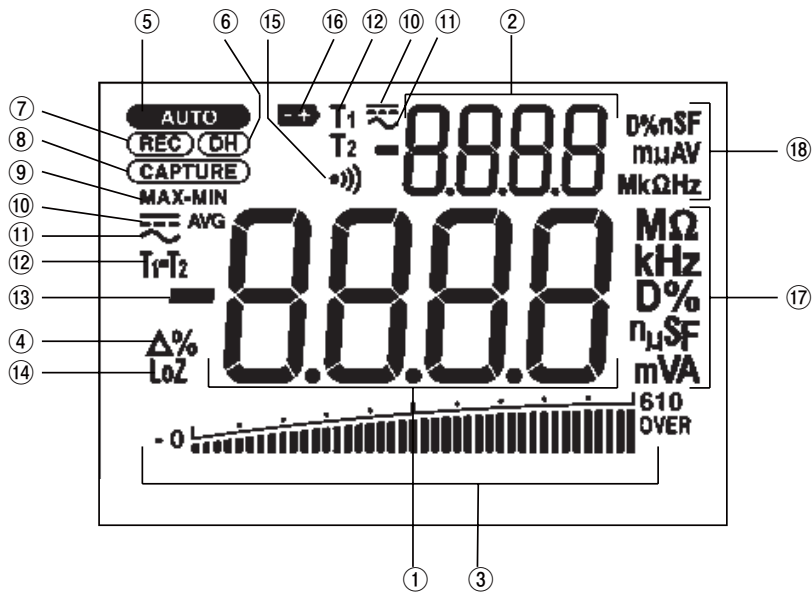

①	Main display
②	Sub display
③	Analog bar graph
④	Relative mode indicator
⑤	Auto range mode indicator
⑥	Data hold indicator
⑦	Recording mode indicator
⑧	Crest capture mode indicator
⑨	Max/Min updating indicator
⑩	DC measurement indicator
⑪	AC measurement indicator
⑫	Temperature measurement indicator
⑬	Polar character
⑭	Low impedance measurement indicator
⑮	Continuity check indicator
⑯	Low battery voltage indicator
⑰	Unit of readings for main display
⑱	Unit of readings for sub display

[4] DESCRIPTION OF FUNCTIONS

4-1 Power Switch/Function Selector

Turn the switch to turn on/off the power and select a measuring function. All segments of the LCD display will be turned on for 2 seconds after power-on, and then the meter will be ready to use.

Note:

The push buttons between the display and the function selector work differently depending on how long you press. In this manual, "press" means pressing momentary and "press and hold for 1 sec. or more" means pressing longer.

4-2 Auto Power Saving

The Auto Power Saving mode turns the meter off automatically after approximately 30 minutes of no activities. While the Auto Power Saving mode, following activities set the Auto Power Saving back.

- 1) Function selector or push button operations
- 2) Non-OL readings in the AutoΩ·V function, Ωfunction, diode test, or continuity check, non-zero readings in the Duty cycle/Frequency measurement functions, any readings in the temperature measurement function, or significant measuring readings of above 512 counts in the other function ranges.

Following activities disable the Auto Power Saving mode automatically.

- 1) Crest capture mode or MAX/MIN recording mode is in use
- 2) Data logging operation is in use
- 3) Data communication to your PC is in use

4-2-1 How to get back from the Auto Power Saving

Press the SELECT, RANGE HOLD, △ REL、 or HOLD button, or disconnect the object to measure and turn the power switch off and then back on, and select a function before connecting the object.

4-2-2 How to disable the Auto Power Saving

Press the SELECT button while turning the meter power on. Release the SELECT button after **AUTO** is turned off. (All segments of the display turn on after power-on.) Then the meter will be ready to use.

Turn the power switch OFF and then back on to resume.

Note:

Even in the Auto Power Saving mode, approx. 50 μ A will be consumed. When in the auto power saving mode, intense light like the direct sunlight into the optical communication unit on the back of the DMM increases the consumption current. To prevent unexpected battery wearing down, mount the attached light shielding magnet cap on the optical communication unit connector when not in use. Always turn the power switch to the OFF position when the meter is not in use for a long time.

4-3 Low Battery Indication

Decreasing the internal battery voltage to approx. 7 V due to wearing down turns on the **+** indicator on the LCD display. Replace the battery with new one when the indicator turns on.

Use under "Low Battery" may cause malfunctions and "InEr" may be indicated on the display. Replace the battery with new one to release the error.

4-4 Measuring Function Selection

At each position of the function selector, press SELECT button (\Rightarrow) to select measuring functions as follows.

* Dual display: [Main display/Sub display]

- $\left[\overset{\text{Auto}}{\Omega \cdot V} \right]$: [Auto Ω (LoZ)] \Rightarrow [\tilde{V} (LoZ)] \Rightarrow [\tilde{V} (LoZ)] \Rightarrow [Ω (LoZ)] \Rightarrow [Auto Ω V(LoZ)] \Rightarrow ...
- $\left[\text{Hz} \tilde{V} \right]$: [\tilde{V} /Hz] \Leftrightarrow [Hz/ \tilde{V}]
- $\left[\tilde{V} \tilde{V} \right]$: [\tilde{V}] \Rightarrow [\tilde{V} / \tilde{V}] \Rightarrow [\tilde{V} / \tilde{V}] \Rightarrow [\tilde{V}] \Rightarrow ...
- $\left[\overset{\text{D\%}}{\mu\text{Hz}} \tilde{m}\tilde{V} \right]$: [$m\tilde{V}$] \Rightarrow [$m\tilde{V}/m\tilde{V}$] \Rightarrow [$m\tilde{V}/m\tilde{V}$] \Rightarrow [μHz] \Rightarrow [D%] \Rightarrow [$m\tilde{V}$] \Rightarrow ...
- $\left[\text{Hz} \tilde{m}\tilde{V} \right]$: [$m\tilde{V}$ /Hz] \Leftrightarrow [Hz/ $m\tilde{V}$]

- $\left[\overset{\text{nS}}{\Omega} \right]$: [Ω] \Rightarrow [\bullet] \Rightarrow [nS] \Rightarrow [Ω] \Rightarrow ...
- $\left[\text{Temp} \right]$: [C] \Leftrightarrow [F] (C:°C, F:°F)
- $\left[\text{H} \rightarrow \text{H} \right]$: [H] \Leftrightarrow [\rightarrow H]
- $\left[\overset{\text{A}}{\text{mA}} \tilde{A} \right]$: [(m) \tilde{A}] \Rightarrow [(m) \tilde{A} /(m) \tilde{A}] \Rightarrow [(m) \tilde{A} /(m) \tilde{A}] \Rightarrow [(m) \tilde{A} Hz] \Rightarrow [(m) \tilde{A}] \Rightarrow ...
- $\left[\overset{\text{A}}{\mu\text{A}} \tilde{A} \right]$: [$\mu\tilde{A}$] \Rightarrow [$\mu\tilde{A}/\mu\tilde{A}$] \Rightarrow [$\mu\tilde{A}/\mu\tilde{A}$] \Rightarrow [$\mu\tilde{A}$ Hz] \Rightarrow [$\mu\tilde{A}$] \Rightarrow ...

At the Temp position, press REANGE HOLD button (\Rightarrow) to select what the display shows on the temperature measurement as follows.

[T1] \Rightarrow [T2] \Rightarrow [T1+T2] \Rightarrow [T1-T2 + T2] \Rightarrow [T1] \Rightarrow ...

Note:

The last selection of each function will be saved as power up default for repeat measurement convenience.

(Except $\overset{\text{Auto}}{\Omega \cdot V}$ function)

4-5 Range Hold

Press the RANGE HOLD button to select manual-ranging, and the meter will remain in the range it was in. (**AUTO** turns off.) In the manual-ranging mode, press the button again to step through the ranges. Select an appropriate range making sure units and decimal point positions. To resume auto-ranging mode, press and hold the button for 1 second or more.

Note:

Manual ranging mode is not available in the Hz functions.

4-6 (DH) Data Hold

Press HOLD button to freeze present reading for later view. ((DH) indicator turns on.) Input fluctuation will not reflect on the indicated value. Press the HOLD button again to disable the data hold feature and go back to the normal measurement mode. ((DH) indicator turns off.)

Note:

Function changes or functional operations will cancel the data hold feature.

4-7 Beeper Control

Press the RANGE HOLD button while turning the meter power on to disable the beeper. Release the RANGE HOLD button after $\bullet \Rightarrow$ is turned off. (All segments of the display turn on right after power-on.) Then the meter will be ready to use. Turn the power switch OFF and then back on to resume.

Note:

The beeper for the continuity check and the plug improper connection warning will not be disabled.

4-8 PC (Personal Computer) Interface

The instrument equips with an optical isolated interface port at the meter back for data communication. KB-USB7, dedicated USB optical communication unit (separately available), and PCLink7, dedicated software, allow you to transfer real time readings and internally logged data to your PC. For more information, see the "HELP" for PCLink7 (PC linkage software).

USB Optical Communication Unit
(KB-USB7)

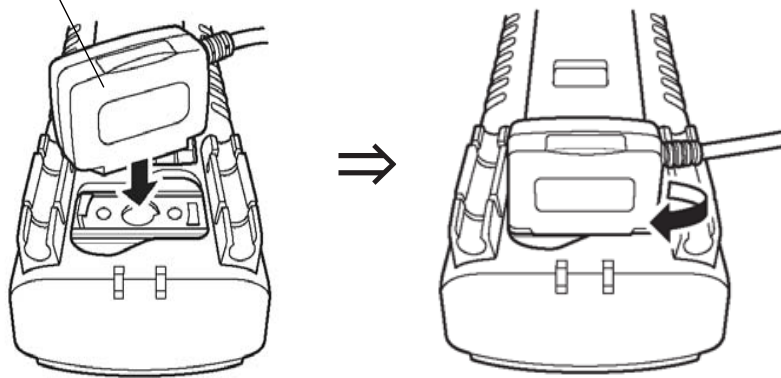

Optical Communication Unit Connection

Note:

Intense light like the direct sunlight into the optical communication unit on the back of the DMM increases the consumption current. Mount the attached light shielding magnet cap on the optical communication unit connector when not in use.

4-9 Data Logging (Recording)

The data logging feature to store up to 87,328 readings (single display) or 43,664 readings (dual display) The instrument employs nonvolatile memory. The internal memory data will remain even after power-off or replacing the battery.

Note:

- The data logging feature is not available in $\left[\begin{array}{c} \text{Auto} \\ \Omega-V \end{array} \right]$ mode.
- Use of data logging function disables the crest capture mode, MAX/MIN recording mode, the relative measurement, and Data Hold function.

4-9-1 Set logging interval

- ① Select a function you need, then press \odot button for 1 sec. or more.
- ② The sampling speed (interval) will be displayed in second. The "t0.05" (factory default) means the sampling interval is 0.05 second (20 times /Sec.).
- ③ Press \blacktriangle or \blacktriangledown to select one from followings.
(Shortest) 0.05 s, 0.1 s, 0.5 s, 1 s, 2 s, 3 s, 4 s, 5 s, 10 s, 15 s, 30 s, 60 s, 120 s, 180 s, 300 s, 600 s (Longest)

Each of the following functions has its specific shortest time interval.

- [T1], [T2], [\rightarrow], [Ω], [nS]: 0.1 s (Shortest)
 - [μ Hz], [D%], [Hz/ \tilde{V}], [Hz/m \tilde{V}]: 0.5 s (Shortest)
 - [\leftarrow], [T1/T2], [T1-T2/T2]: 2 s (Shortest)
- ④ Press \odot button for 1 sec. or more to set. Then newly set time interval on the display will blink 2 times to make sure.

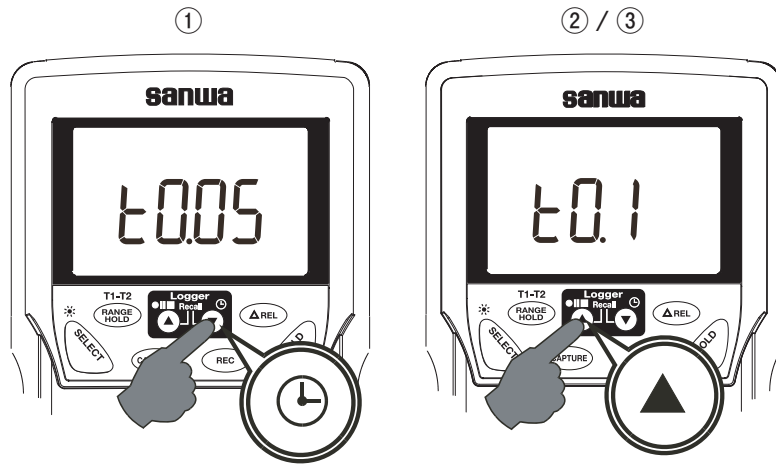

More than 1 second

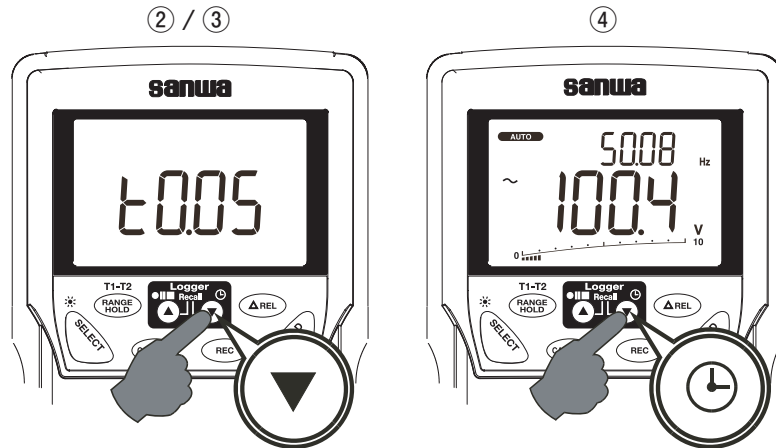

More than 1 second

4-9-2 Start/Stop Data Logging

- The Meter supports multi-session data-logging. Multiple functions can be logged one-at-a-time into the meter's free memory up to 999 separate session-pages without erasing the formerly logged one(s).

- Press **●||■** button for 1 sec. or more to start the data-logging mode. "LEFT" displays momentarily followed by a number to indicate the memory points left for new logging session(s). (Sub / main displays for most-significant / least-significant numbers separately.)

When the number of logged data reaches the loggable max value, **0000** will be indicated and the logging ends. If you need the logged data in the internal memory, transfer the data to your PC and save them. (See 4-8 on the page 11.) To start a new logging session, erase the past logged data.

Below example illustrates 43,102 memory points are available for new logging session(s).

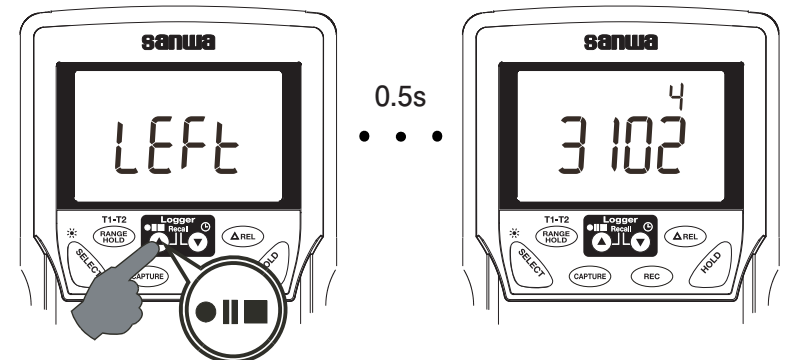

More than 1 second

- Then press the **●||■** button to start a new logging session directly without erasing the formerly logged one(s). Or you can press the **▼** button to erase ALL of the formerly logged session-page(s), and start a new logging session from the very first session-page (P.001) with maximum meter memory.
- The bar-graph turns to a swinging pointer when data-logging mode is running.

New logging starts
without erasing

New logging starts
after erasing

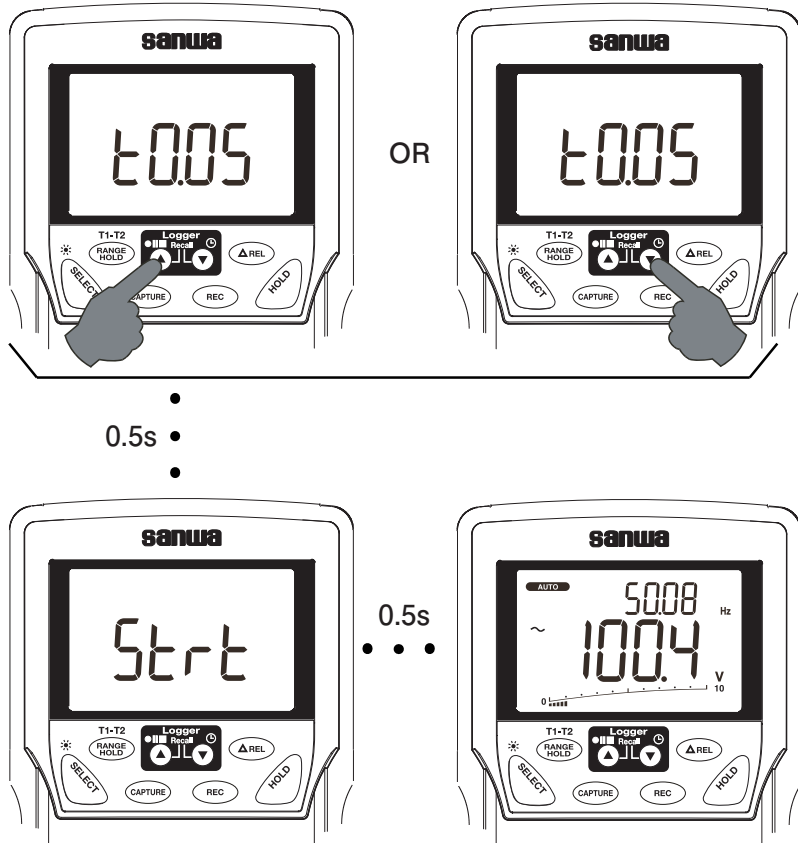

- Press SELECT button to toggle the LCD display between measuring data and logged data item number. (Sub / main displays for most-significant / least-significant numbers separately.)

4-9-3 Pause/Continue Data Logging

- Press ●||■ (PAUS/CONT/STOP) button to pause/continue/stop logging.
- Press ●||■ (PAUS/CONT/STOP) button for 1 sec. or more to stop logging.
- When a sampling speed of 30 s or longer is selected, the meter will enter a 50 % power down mode between data logging measurements displaying only the swinging pointer. Press the SELECT button to resume the real time display, approx. 4.2 minutes after data logging has started.

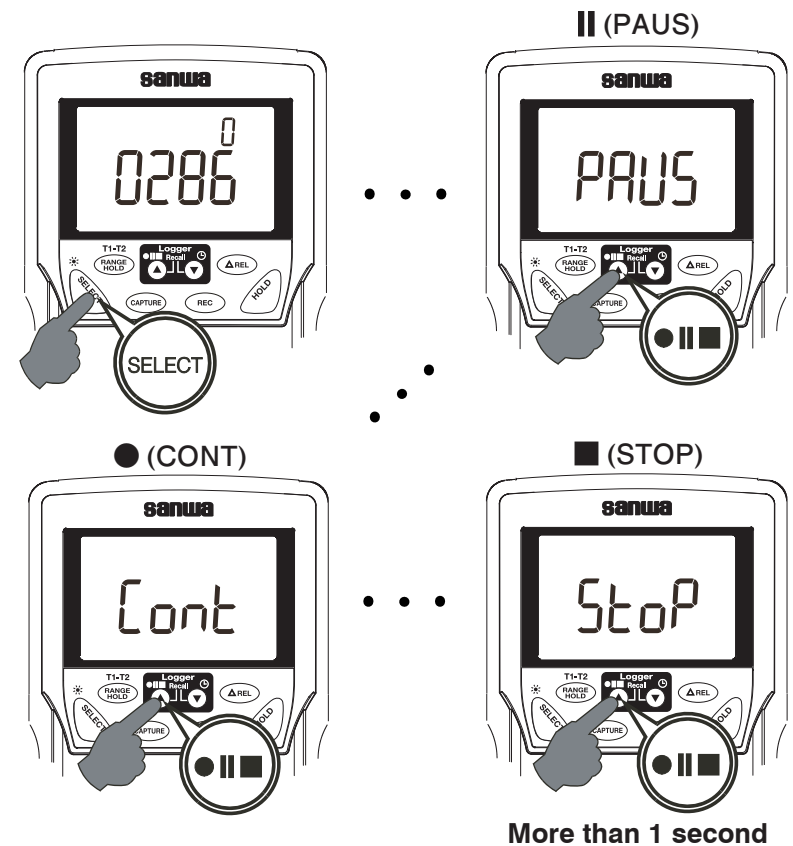

4-9-4 Recall logged data

- Press the ▲ and ▼ buttons simultaneously to enter the Recall mode. The last session-page number shows up for 0.5 second before displaying the last logged data item. (REC) and (CAPTURE) indicators turn on.
- Press the ▲ or ▼ button to review the logged data one-at-a-time in sequence. Press and hold for 1 sec. or more for fast scrolling. The beeper sounds when the first or last data is reached.
- Press the SELECT button to toggle the LCD display between logged data and its item number.
- Press the RANGE HOLD button to make sure the set reading time interval.

Press the ▲ and ▼ buttons simultaneously again to select another session-page in sequence. Press them and hold for 1 sec. or more for fast scrolling, and the beeper sounds when the first or last page is reached.

Turn the function selector to another function or OFF to exit the RECALL mode.

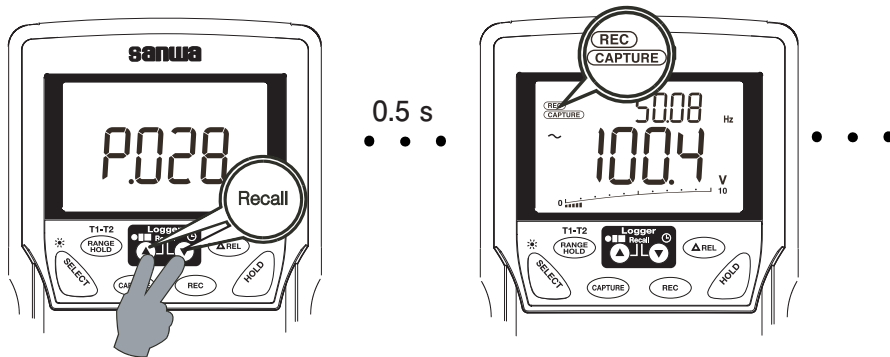
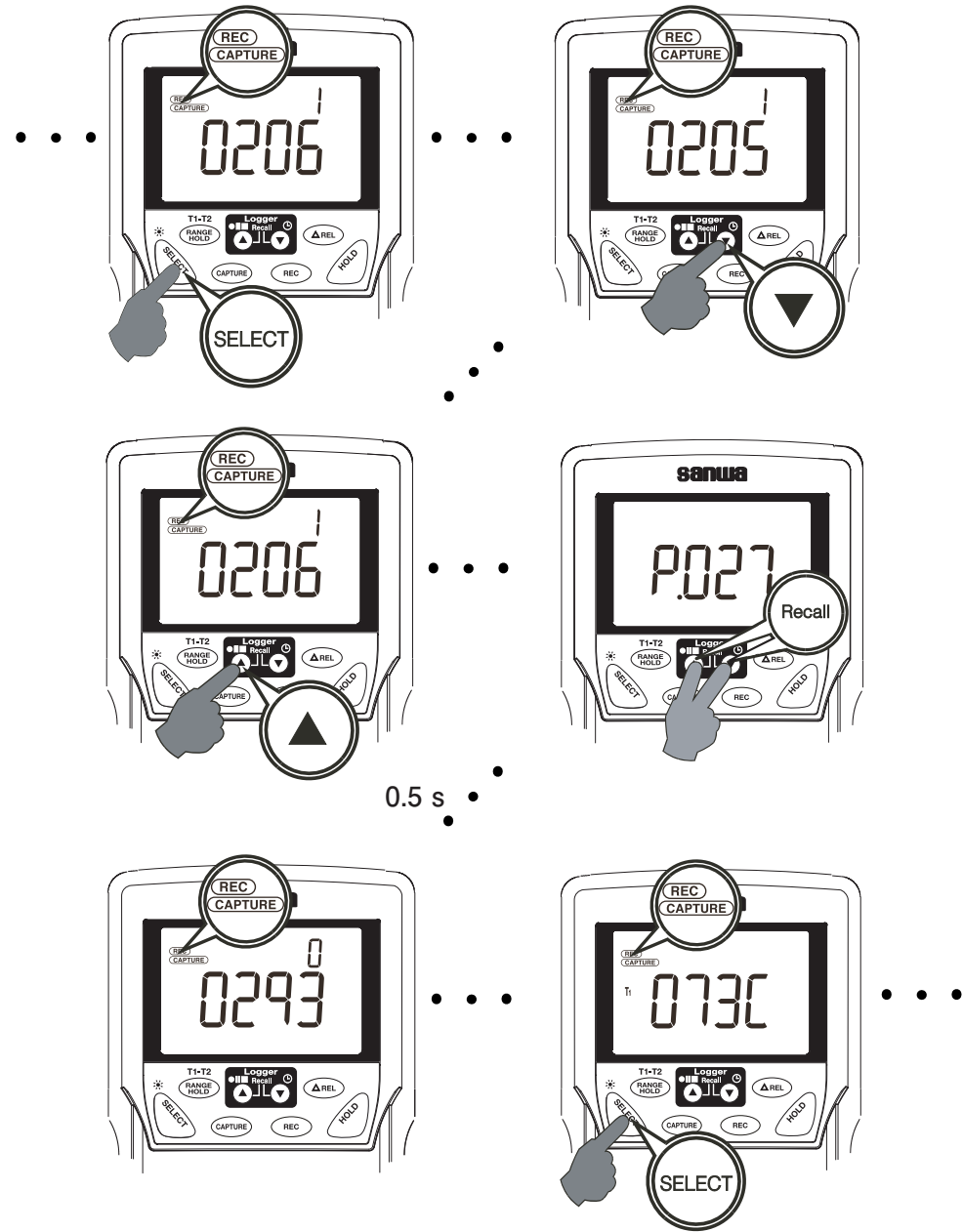

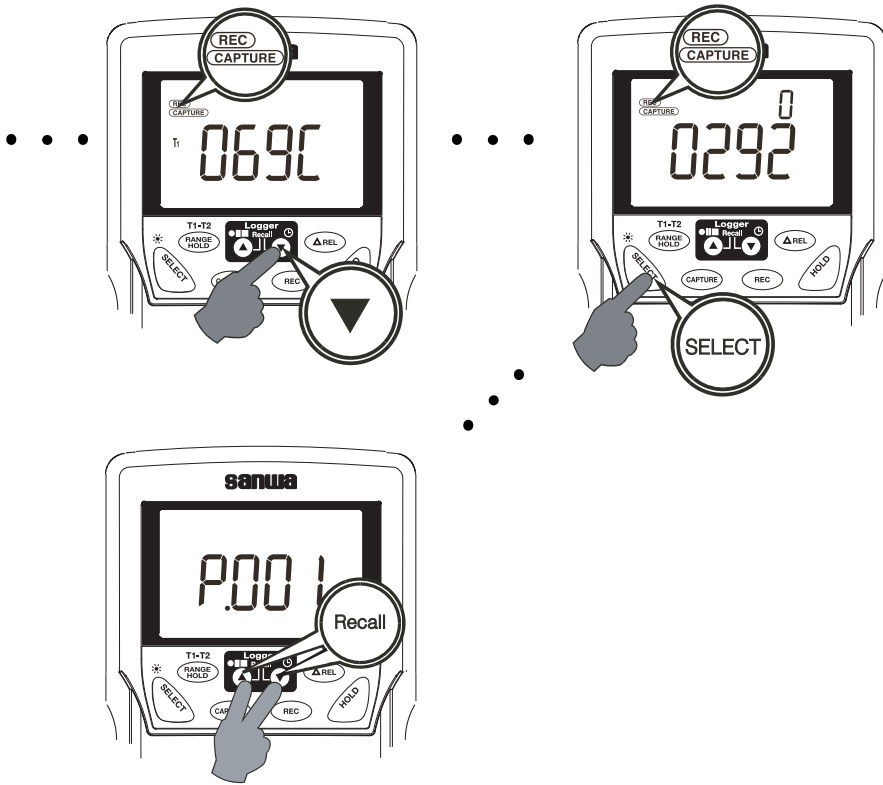

4-10 Test Leads Improper Connection Warning

The meter beeps as well as displays “InEr” to warn the user against possible damage to the meter due to test leads improper connections to the mA μ A, or A measuring jacks when other function (like voltage function) is selected. (Temperature measurement function is an exception.)

Note:

“InEr” warning may be indicated due to weak battery even if the test leads are connected properly.

4-11 CAPTURE Crest capture mode (Sampling time: 1 ms)

Press the CAPTURE button to activate the crest (Instantaneous Peak-Hold) mode to capture voltage or current signal duration which is longer than 1 ms. CAPTURE and MAX indicators turn on. The meter beeps when new MAX (maximum) or MIN (minimum) reading is updated. Press the button to read the MAX, MIN, and MAX-MIN (peak to peak) readings in sequence. Press the button for 1 sec. or more to exit the crest mode. Auto-ranging (up range) remains, and Auto Power Saving is disabled automatically in this mode.

4-12 REC MAX/MIN Recording Mode

When this mode is activated, the reading update rate will be increased to 20 times/sec. in the voltage measurement or current measurement function, and the update rate in the other function ranges will remain.

Press the REC button to activate the MAX/MIN recording mode. REC and “MAX-MIN” turn on. The meter beeps when new MAX (maximum) or MIN (minimum) reading is updated. Press the button to read the MAX, MIN, and MAX-MIN (peak to peak) readings in sequence. Press the button for 1 sec. or more to exit the MAX/MIN recording mode. Auto-ranging remains, and Auto Power Saving is disabled automatically in this mode.

4-13 Δ Relative Measurement

Press the Δ REL button to activate the relative measurement mode and Δ indicator turns on. The relative measurement mode offsets the meter to display relative values against a reference. The meter displays its readings subtracting the reading at the moment the Δ REL button is pressed. Press Δ REL button again to exit the relative measurement mode. This feature is available also while the MAX/MIN recording mode.

4-14 Back Light

Press the SELECT button for 1 sec. or more to turn the backlight on. (Automatically turns off after approx. 30 sec.)

Press the SELECT button again for 1 sec. or more to turn the backlight off.

4-15 Terms

Analog bar graph

The analog bar graph provides a visual indication of measurement like a traditional analog meter needle.

True RMS

True RMS is a term which identifies a DMM that responds accurately to the effective RMS value regardless of the waveforms such as: square, sawtooth, triangle, pulse trains, spikes, as well as distorted waveforms with the presence of harmonics. This instrument employs the True-RMS (Root-Mean-Square) detection.

Crest Factor

Crest Factor is the ratio of the Crest (instantaneous peak) value divided by the True RMS value. Most common waveforms such as sinusoidal wave and chopping wave have a relatively low crest factor. A low duty cycle wave form like pulse string has a high crest factor. For voltages and crest factors for typical waveforms, see the table below. Please note that measurement should be made under the crest factor below 3.

	Input Waveform	0 to PEAK V_p	Root Mean Square Value V_{rms}	Average Value V_{avg}	Crest Factor V_p/V_{rms}	Form Factor V_{rms}/V_{avg}
Sinusoidal wave		V_p	$\frac{V_p}{\sqrt{2}}$ $=0.707V_p$	$\frac{2V_p}{\pi}$ $=0.637V_p$	$\sqrt{2}$ $=1.414$	$\frac{\pi}{2\sqrt{2}}$ $=1.111$
Square wave		V_p	V_p	V_p	1	1
Chopping wave		V_p	$\frac{V_p}{\sqrt{3}}$ $=0.577V_p$	$\frac{V_p}{2}$ $=0.5V_p$	$\sqrt{3}$ $=1.732$	$\frac{2}{\sqrt{3}}$ $=1.155$
Pulse		V_p	$\sqrt{\frac{\tau}{2\pi}} \cdot V_p$	$\frac{\tau}{2\pi} \cdot V_p$	$\sqrt{\frac{2\pi}{\tau}}$	$\sqrt{\frac{2\pi}{\tau}}$

[5] Measuring procedures

5-1 Pre-operational Check

⚠ WARNING

1. Do not use the instrument if the meter or test leads look damaged.
2. Make sure the test leads and the fuse are not broken.

⚠ CAUTION

Make sure the low battery indicator is off after power-on. Replace the battery with new one if the indicator is on.

Perform pre-operational check for safety.

(Inspection using continuity check)

Check for the continuity.

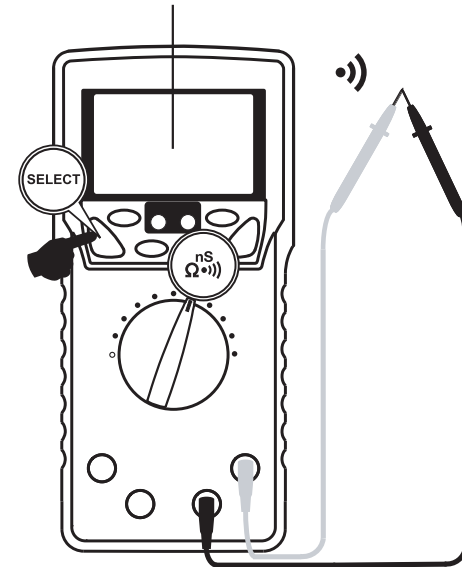

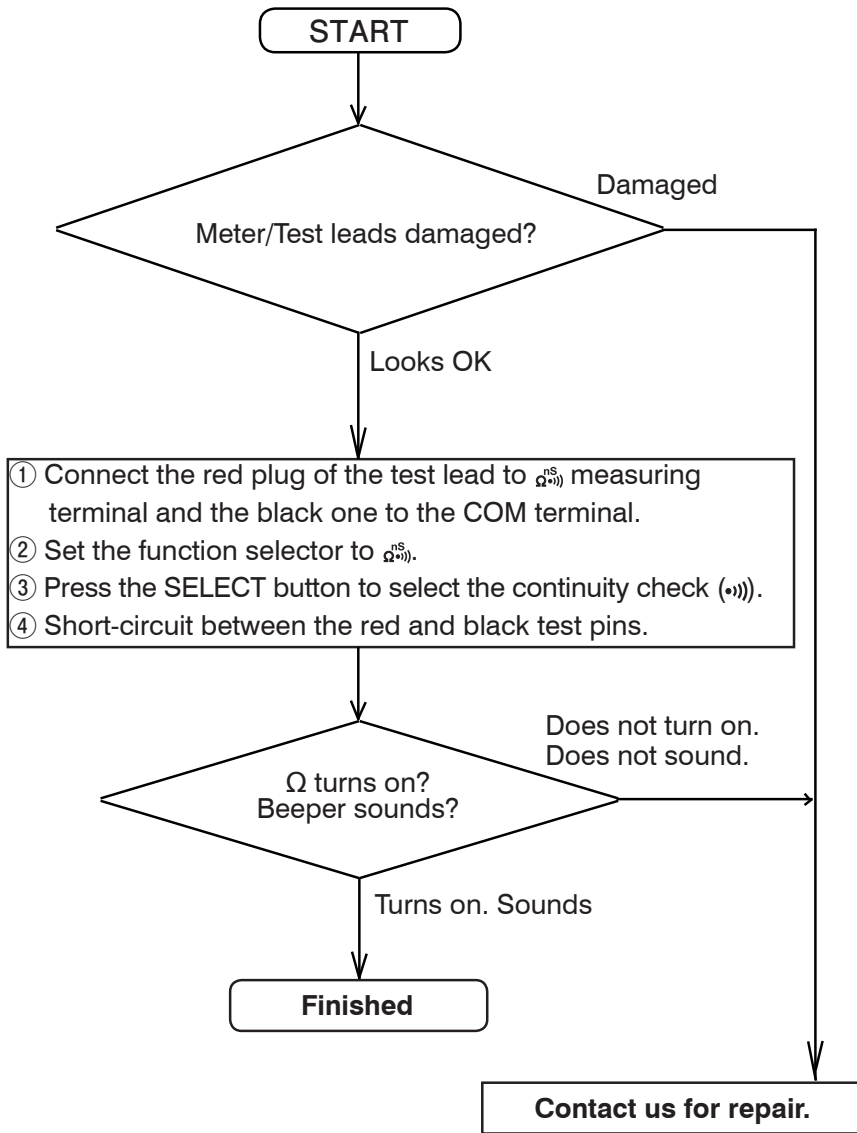

*In the case nothing is displayed, check for the battery.

5-2 [Auto Ω·V] (Max. rated input voltage: 1,000 V dc/ac, Initial impedance: 3 kΩ)

- Automatic measurement for Ω·V under Low Impedance

⚠ WARNING

Auto Ω·V mode input impedance increases abruptly from initial 3 kΩ to a few hundred kΩ's on high voltage hard signals. "LoZ" displays on the LCD to remind the users of being in such low impedance mode.

Peak initial load current, while probing 1000 V ac for example, can be up to 471 mA (1000 V x 1.414 / 3 kΩ), decreasing abruptly to approx. 3.1 mA (1000 V x 1.414 / 460 kΩ) within a fraction of a second.

Do not use AutoΩ·V mode on circuits that could be damaged by such low input impedance. Instead, use function selector \tilde{V} or \bar{V} high input impedance voltage modes to minimize loading for such circuits.

This AutoΩ·V function automatically selects measurement function of DCV, ACV or Ω (Resistance) based on the input between the test leads.

- With no input, the meter displays "Auto" when it is ready.
- When a signal out of -1.0 Vdc to 1.5 Vdc or 3 Vac up to the rated 1,000 V is present, the meter displays the voltage value in appropriate DC or AC, whichever larger in peak magnitude.
- With no voltage signal but a resistance below 60 MΩ is present, the meter displays the resistance value. When below the continuity threshold (20 Ω to 300 Ω) is present, the meter further gives a continuity beep tone.

1) Measuring range (Automatic function selection)

- LoZ \bar{V} : 1.5 Vdc to 999.9 Vdc, -1.0 V to -999.9 Vdc
- LoZ \tilde{V} : 3 Vac to 999.9 Vac (50/60 Hz)
- LoZ Ω : 0.0 Ω to 60.00 M Ω

2) Measuring procedure

- ① Connect the red plug of the test lead to the Auto Ω ·V measuring terminal and the black one to the COM terminal.
- ② Set the function selector to **Auto Ω ·V**.
- ③ Apply the test pins (Red and Black) to the object to measure.
- ④ Read the display.

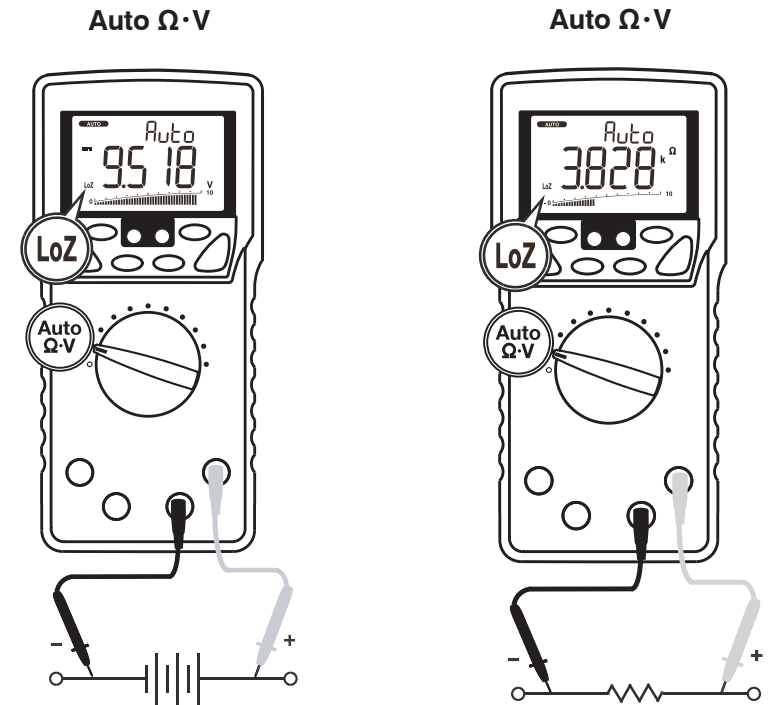
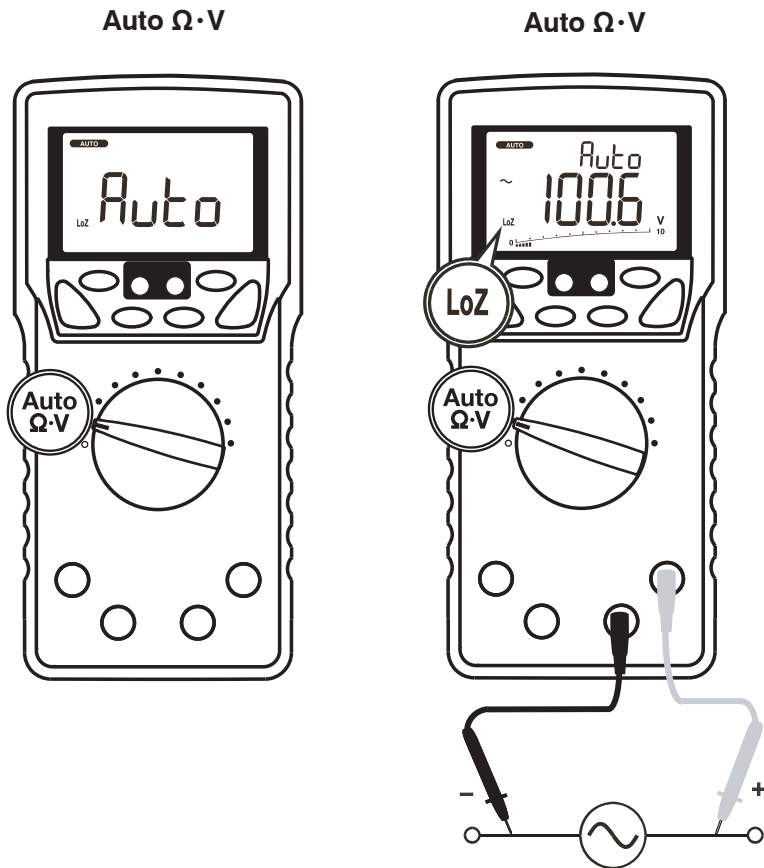

Note:

- Range-Lock and Function-Lock Feature:
When a measurement reading is being displayed in Auto Ω ·V mode, press the RANGE or SELECT button to lock the range or function it was in. Press the button repeatedly to step through the ranges or functions.
- Voltage Hazardous Alert:
When making resistance measurements in Auto Ω ·V mode, an unexpected display of voltage readings alerts you that the object under test is being energized.
- Ghost voltage Buster:
Ghost voltages are unwanted stray signals coupled from adjacent hard signals. Our Auto Ω ·V mode provides low (ramp-up) input impedance (approx. 3 k Ω at low voltage) to drain ghost voltages leaving major signal values on meter readings.

5-3 [Hz \tilde{V}] (Max. rated input voltage: 1,000 V dc/ac)

• AC Voltage (\tilde{V})/Frequency (Hz) Simultaneous Measurement

⚠ WARNING

1. Do not apply any input signal exceeding the max. rated input voltage.
2. Do not switch the function selector while measuring.
3. Keep your fingers behind the finger guards of the test leads while measurement.

1) What to measure

- \tilde{V} (ACV): Sine wave voltages such as output from a wall socket.
- Hz (Frequency): Frequency on a AC circuit.

2) Measuring ranges

- \tilde{V} : 9.999 V, 99.9 V, and 999.9 V
- Hz: 15.00 Hz to 10.00 kHz (Auto ranging)

3) Measuring procedure

- ① Connect the red plug of the test lead to the VHz measuring terminal and the black one to the COM terminal.
- ② Set the function selector to Hz \tilde{V} .
- ③ Press the SELECT button to select a display style.
- ④ Apply the test pins (Red and Black) to the object to measure.
- ⑤ Read the display.

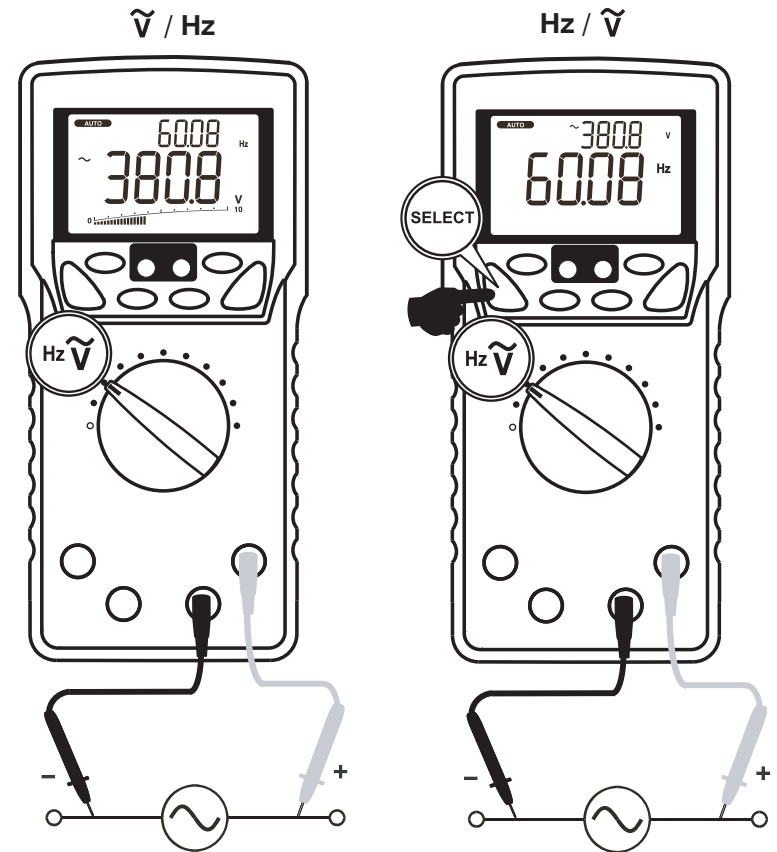

Note:

Hz input sensitivity varies automatically with a selected voltage range. 9.999 V range has the highest sensitivity and the 999.9 V range has the lowest sensitivity. Auto ranging measurements normally set the most appropriate trigger level. You can also press the RANGE HOLD button to select another trigger level (voltage range) manually.

If the Hz reading becomes unstable, select higher voltage range to avoid electrical noise. If the reading shows zero, select lower voltage range.

Range	Frequency measurement (Hz) Input sensitivity (Sine wave)	Frequency range
9.999 V	2.5 V	15.00 Hz to 10.00 kHz
99.99 V	25 V	
999.9 V	100 V	

The display style of [Hz/ \tilde{V}] does not show the bar graph.
As a normal condition, non-connected test leads may cause unstable readings.

5-4 [$\overline{\tilde{V}}$] (Max. rated input voltage: 1,000 V dc/ac)

- **DC Voltage($\overline{\tilde{V}}$) measurement**
- **DC Voltage($\overline{\tilde{V}}$)/AC Voltage(\tilde{V}) simultaneous measurement**
- **DC+AC voltage($\overline{\tilde{V}}$)/AC Voltage(\tilde{V}) simultaneous measurement**

⚠ WARNING

1. Do not apply any input signal exceeding the max. rated input voltage.
2. Do not switch the function selector while measuring.
3. Keep your fingers behind the finger guards of the test leads while measurement.

1) What to measure

- $\overline{\tilde{V}}$ (DC Voltage): Batteries, DC circuit voltages, etc.
- $\overline{\tilde{V}}/\tilde{V}$ (DC voltage component/AC voltage component)
- $\overline{\tilde{V}}/\tilde{V}$ (DC/AC superimposed signal voltage/AC voltage component)

2) Measuring ranges

- $\overline{\tilde{V}}$, $\overline{\tilde{V}}/\tilde{V}$, $\overline{\tilde{V}}/\tilde{V}$: 9.999 V, 99.99 V, 999.9 V

3) Measuring procedure

- ① Connect the red plug of the test lead to the V measuring terminal and the black one to the COM terminal.
- ② Set the function selector to $\overline{\tilde{V}}$.
- ③ Press the SELECT button to select a function you want to perform.
- ④ Apply the test pins (Red and Black) to the object to measure.
- ⑤ Read the display.

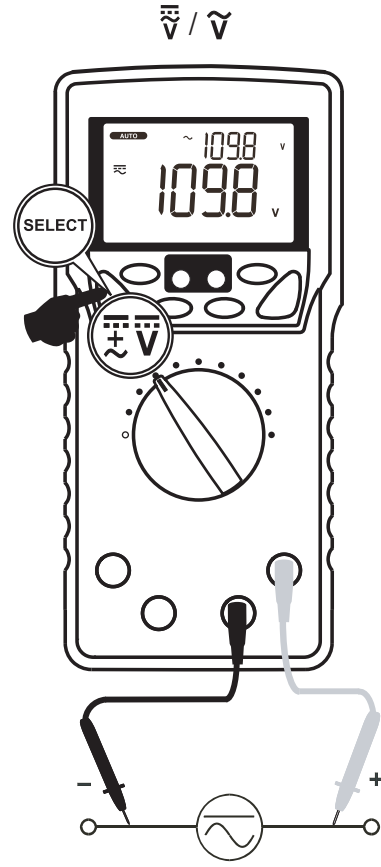
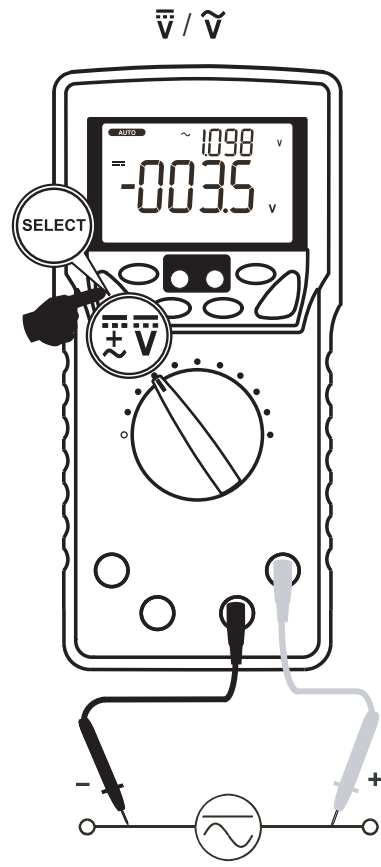
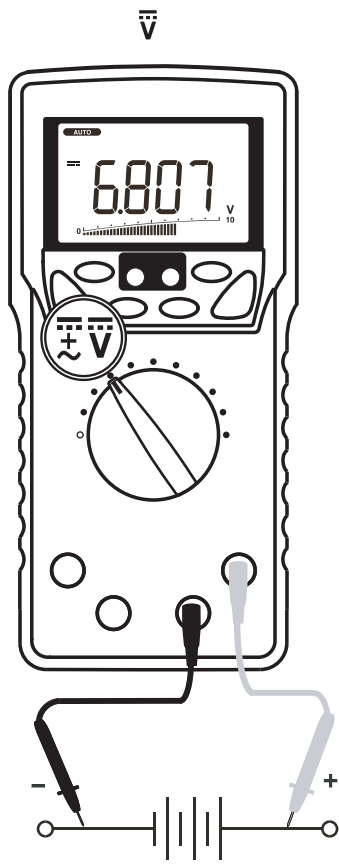

Note:

- The display style of $[\bar{V} / \tilde{V}]$ or $[\bar{V} / \tilde{V}]$ does not show the bar graph.

5-5 $\left[\frac{D\%}{\mu\text{Hz}} \text{ } \overline{\overline{\text{mV}}} \right]$ (Max. rated input voltage: 10 V dc/ac)

- DC voltage ($\overline{\overline{\text{mV}}}$) measurement
- DC Voltage ($\overline{\overline{\text{mV}}}$)/AC Voltage($\overline{\widetilde{\text{mV}}}$) simultaneous measurement
- DC+AC Voltage ($\overline{\overline{\text{mV}}}$)/AC Voltage ($\overline{\widetilde{\text{mV}}}$) simultaneous measurement
- Logic-level frequency ($\overline{\mu\text{Hz}}$) measurement
- Duty cycle ($\overline{\mu\text{D}\%}$) Measurement

⚠ WARNING

1. Do not apply any input signal exceeding the max. rated input voltage.
2. Do not switch the function selector while measuring.
3. Keep your fingers behind the finger guards of the test leads while measurement.

1) What to measure

- $\overline{\overline{\text{mV}}}$ (DC voltage): DC circuit voltage lower than 600 mV
- $\overline{\overline{\text{mV}}} / \overline{\widetilde{\text{mV}}}$ (DC voltage component/AC voltage component)
- $\overline{\overline{\text{mV}}} / \overline{\widetilde{\text{mV}}}$ (DC/AC superimposed signal voltage/AC voltage component)
- $\overline{\mu\text{Hz}}$ (Logic level frequency): 3 V, 5 V logic circuit frequency
- $\overline{\mu\text{D}\%}$ (Duty cycle): Logic level signal duty cycle (Square wave)

2) Measuring ranges

- $\overline{\overline{\text{mV}}}$, $\overline{\overline{\text{mV}}} / \overline{\widetilde{\text{mV}}}$, $\overline{\overline{\text{mV}}} / \overline{\widetilde{\text{mV}}}$: 60.00 mV and 600.0 mV
- $\overline{\mu\text{Hz}}$: Auto ranging, 5 Hz to 1.000 MHz (Square wave)
- $\overline{\mu\text{D}\%}$: 0.00 % to 100.0 % (Square wave 5 Hz to 10 kHz)

3) Measuring procedure

- ① Connect the red plug of the test lead to the VHz measuring terminal and the black one to the COM terminal.
- ② Set the function selector to $\frac{D\%}{\mu\text{Hz}} \overline{\overline{\text{mV}}}$.
- ③ Press the SELECT button to select a function you want to perform.
- ④ Apply the test pins (Red and Black) to the object to measure.
- ⑤ Read the display.

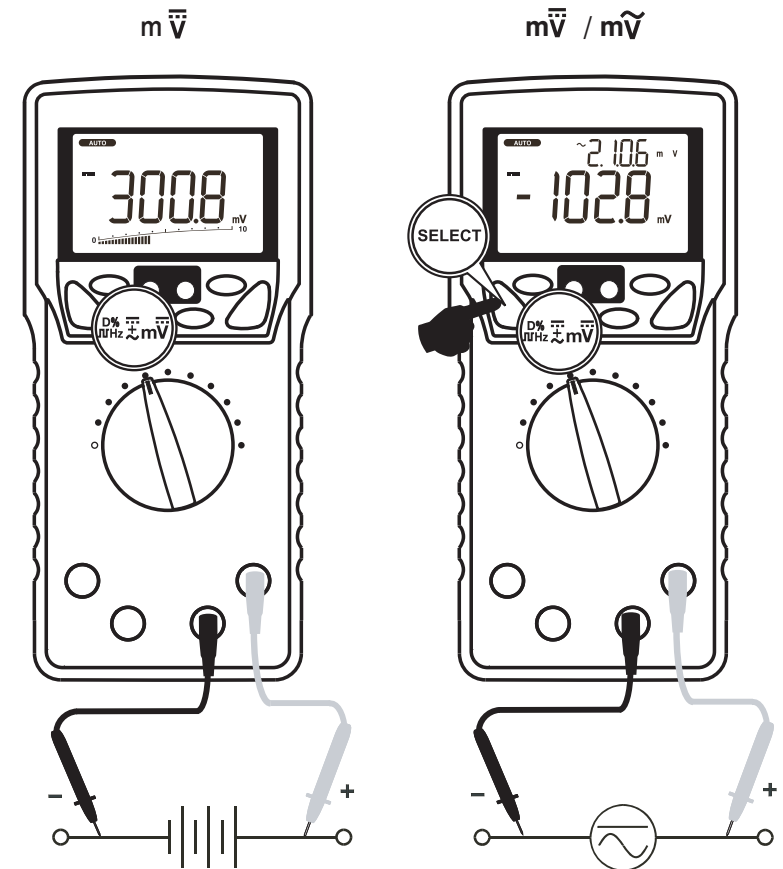

$\overline{mV} / m\tilde{V}$

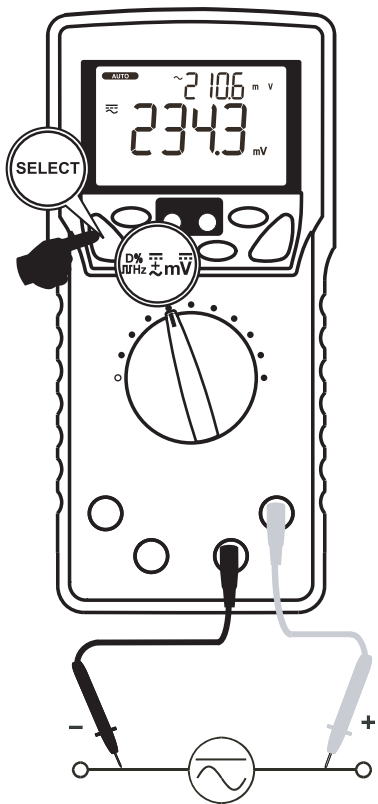

μHz

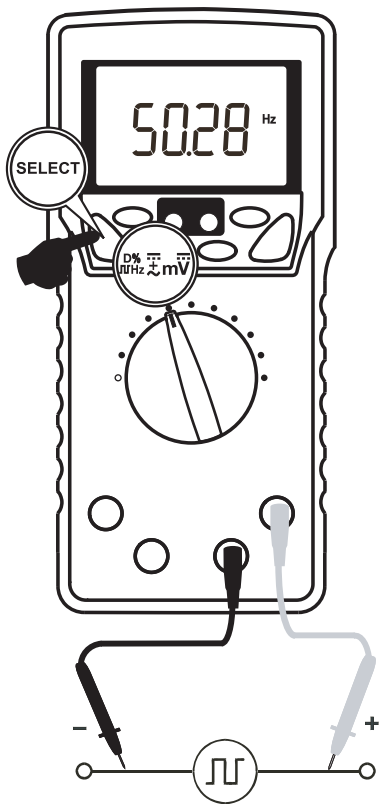

$\mu\text{D}\%$

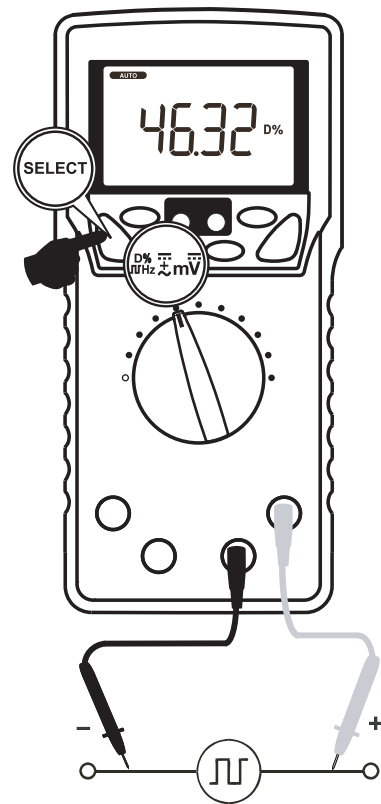

Note:

- The display style of [$\overline{mV} / m\tilde{V}$], [$\overline{mV} / m\tilde{V}$], [μHz], or [$\mu\text{D}\%$] does not show the bar graph.

5-6 $\left[\begin{array}{c} \text{Hz} \\ \text{m}\tilde{\text{V}} \end{array} \right]$ (Max. rated input voltage: 600 mV dc/ac)

• AC Voltage (m $\tilde{\text{V}}$)/Frequency (Hz) Simultaneous Measurement

⚠ WARNING

1. Do not apply any input signal exceeding the max. rated input voltage.
2. Do not switch the function selector while measuring.
3. Keep your fingers behind the finger guards of the test leads while measurement.

1) What to measure

- m $\tilde{\text{V}}$ (AC voltage): AC voltage lower than 600 mV
- Hz (Frequency): Frequency on a AC circuit lower than 600 mV

2) Measuring ranges

- m $\tilde{\text{V}}$: 60.00 mV and 600.0 mV
- Hz: 15.00 Hz to 10.00 kHz (Auto ranging)

3) Measuring procedure

- ① Connect the red plug of the test lead to the VHz measuring terminal and the black one to the COM terminal.
- ② Set the function selector to $\left[\begin{array}{c} \text{Hz} \\ \text{m}\tilde{\text{V}} \end{array} \right]$.
- ③ Press the SELECT button to select a function you want to perform.
- ④ Apply the test pins (Red and Black) to the object to measure.
- ⑤ Read the display.

m $\tilde{\text{V}}$ / Hz

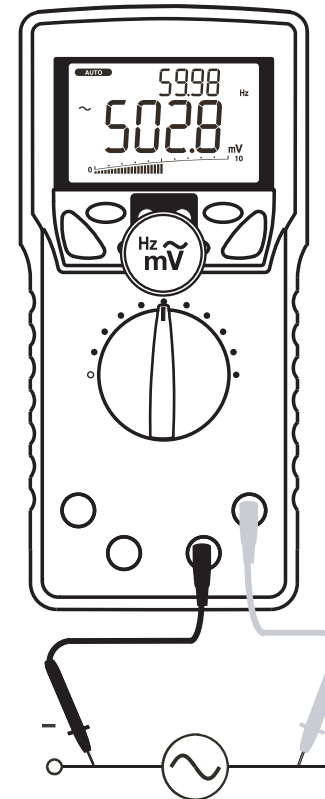

Hz / m $\tilde{\text{V}}$

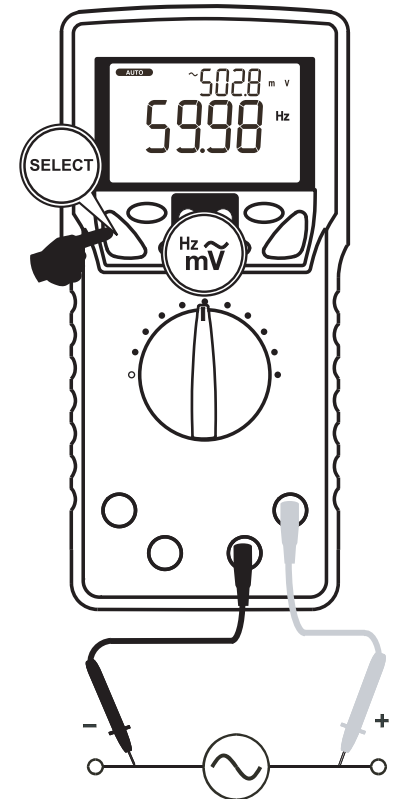

Note:

Range	Frequency measurement (Hz) Input sensitivity (Sine wave)	Frequency range
60.00 mV	40 mV	15.00 Hz to 50.00 kHz
600.0 mV	60 mV	

- The display style of [Hz/m $\tilde{\text{V}}$] does not show the bar graph.
- As a normal condition, non-connected test leads may cause unstable readings.

5-7 $\left[\begin{matrix} \Omega \\ \bullet \bullet \bullet \end{matrix} \right]$ (Do not apply any voltage or current.)

- **Resistance (Ω) measurement**
- **Conductance (nS) Measurement**
- **Continuity Check ($\bullet \bullet \bullet$)**

⚠ WARNING

Do not apply any voltage or current to the measuring terminals.

⚠ CAUTION

In the case of high resistance measurement, readings may be unstable due to external inductive influence.

1) What to measure

- Ω (Resistance): Resistor, circuit resistance, etc.
- $\bullet \bullet \bullet$ (Continuity check): Wiring connections, Operation of switches, etc.
- nS(Conductance): High-value resistance of Giga-Ohms for leakage measurements

Note: Conductance is the inverse of Resistance, that is $S=1/\Omega$ or $nS=1/G\Omega$.

2) Measuring ranges

- Ω : 6 ranges; 600.0 Ω , 6.000 k Ω , 60.00 k Ω , 600.0 k Ω , 6.000 M Ω , and 60.00 M Ω
- $\bullet \bullet \bullet$: Beeper threshold level: between 20 Ω and 300 Ω ,
Response time: <100 μs
- nS : 99.99 nS (Single range)

*Open circuit voltage between the measuring terminals: <1.2 Vdc
(<1.0 Vdc for 60.00 M Ω range)

3) Measuring procedure

- ① Connect the red plug of the test lead to Ω measuring terminal and the black one to the COM terminal.
- ② Set the function selector to Ω .
- ③ Press the SELECT button to select a function you want to perform.
- ④ Apply the test pins (Red and Black) to the object to measure.
- ⑤ Read the display.

$\bullet \bullet \bullet$: A continuous beep tone indicates a complete wire.)

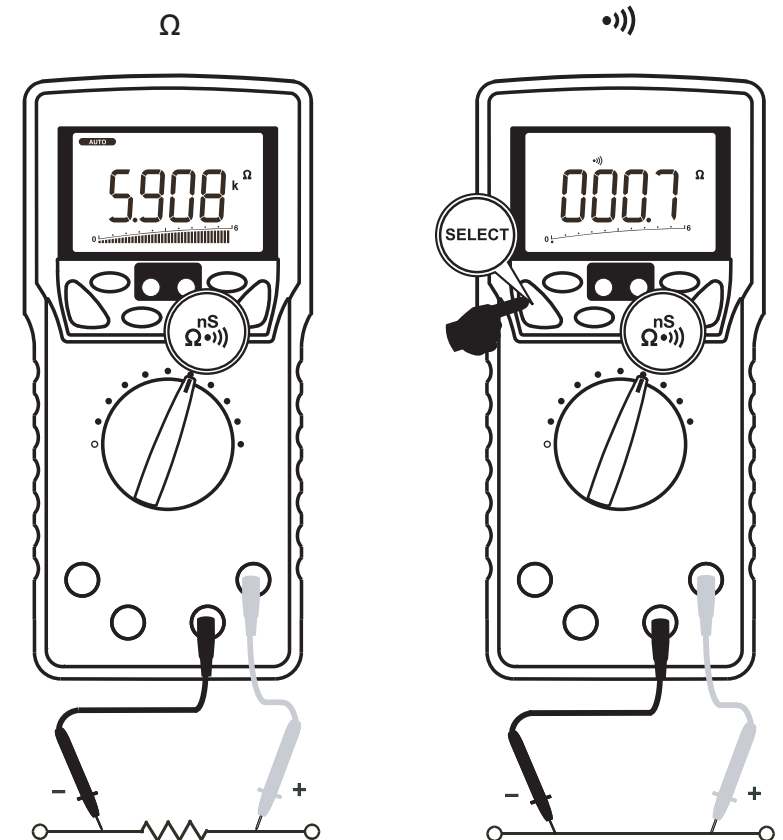

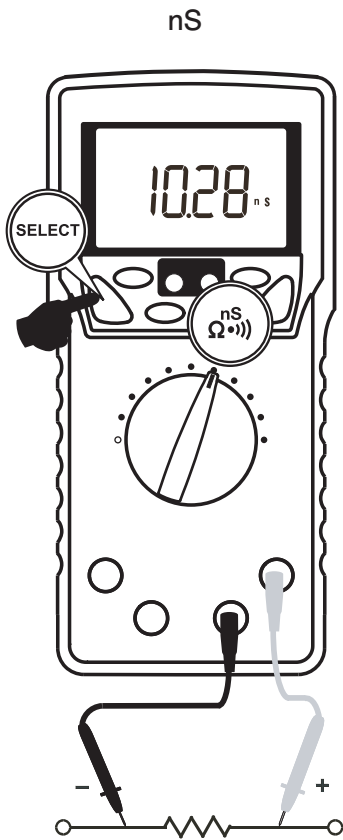

Note:

- [nS] function does not show the bar graph.
- To avoid external noise influence, shield the object to measure with COM potential. Measurements with finger-touched test pins may cause some errors being influenced by human body conductance.

5-8 [Temp] (Max. rated input voltage: 50 mVdc)

- Temperature measurement (°C) or (°F) (For K-type thermocouple)

⚠ **WARNING**

1. Pay attention in order to avoid risk of burn depending on the object temperature or measuring environment.
2. Do not apply exceeding 50 mV to the measuring terminals.

- 1) What to measure
°C , °F (Temperature): Temperature of liquid, solids, gas, and etc.
- 2) Measuring ranges
Celsius: -50 °C to 1,000 °C
Fahrenheit: -58 °F to 1832 °F
- 3) Measuring procedure
 - ① Connect the provided K-type thermocouple(s) to the T1(+/-) and/or T2(+/-) measuring terminals.
 - ② Set the function selector to Temp.
 - ③ Press the SELECT button to select °C or °F.
 - ④ Press the T1-T2 (RENGE HOLD) button to select [T1], [T2], [T1/T2], or [T1-T2 / T2].
 - ⑤ Apply the Thermocouple to the object to measure.
 - ⑥ Read the display.

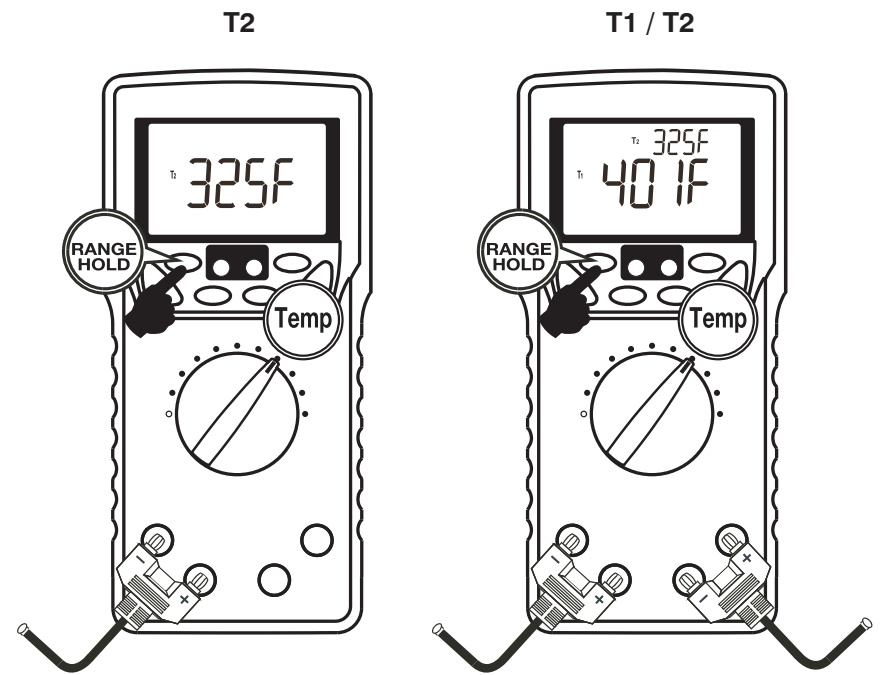
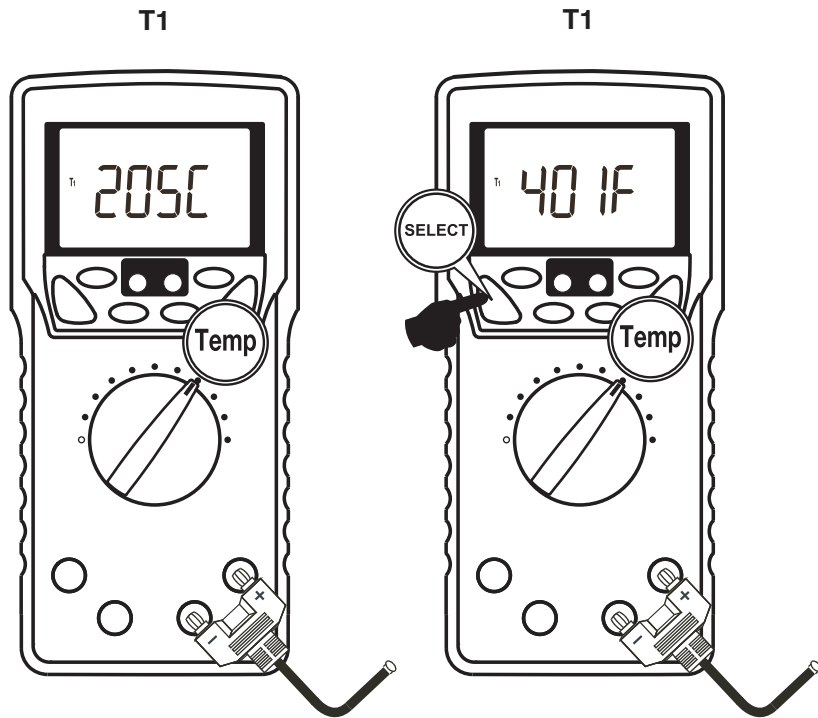

(T1 - T2) / T2

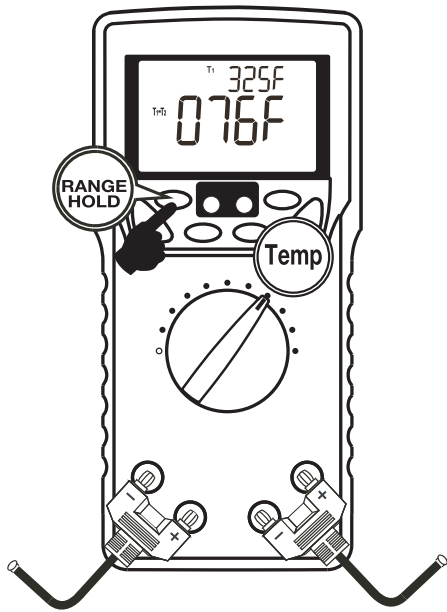

Note:

- Temperature function does not show the bar graph.
- The provided K-type thermocouple (K-250PC) is a polar device. Connect the device to the meter properly.
- The range of K-250PC is -50 °C to 250 °C .
- Separately available K-type adapter (K-AD) allows you to use other international standard mini plug thermocouples.

5-9 [$\text{---}|\text{---}|\text{---}$] (Do not apply any voltage or current.)

- Capacitance ($\text{---}|\text{---}$) measurement
- Diode ($\text{---}|\text{---}|\text{---}$) test

⚠ WARNING

1. Do not apply any voltage or current to the measuring terminals.
2. Measuring live circuit may damage the meter.

5-9-1 Capacitance ($\text{---}|\text{---}$) measurement

⚠ CAUTION

1. Discharge the capacitor before any measurement.
2. The instrument applies the current to the capacitor to measure.
Capacitors with large leakage such as chemical capacitors cannot be measured accurately.

1) What to measure

$\text{---}|\text{---}$ (Capacitance): Capacitance of capacitors

2) Measuring ranges

$\text{---}|\text{---}$: 7 ranges; 60.00 nF, 600.0 nF, 6.000 μ F, 60.00 μ F, 600.0 μ F, 6.000 mF, and 25.00 mF

3) Measuring procedure

- ① Connect the red plug of the test lead to $\text{---}|\text{---}$ measuring terminal and the black one to the COM terminal.
- ② Set the function selector to $\text{---}|\text{---}|\text{---}$, then press the SELECT button to select the capacitance measurement. (Unit "F" will be indicated.)
- ③ Apply the test pins (Red and Black) to the object to measure.
- ④ Read the display.

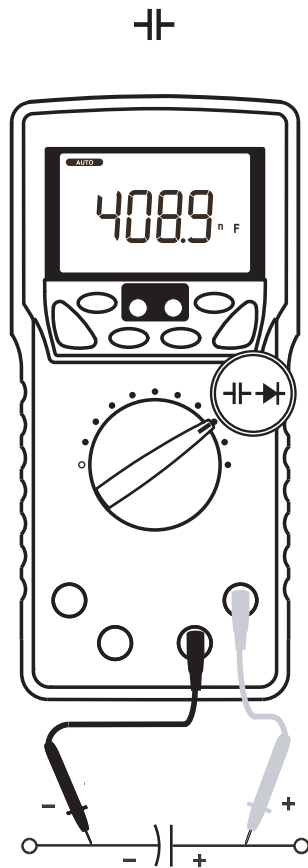

Note:

- Capacitance function does not show the bar graph.

5-9-2 Diode (→|) test

1) What to measure

→| (Diode test): Judging the diode (Good or defective)

2) Measuring procedure

- ① Connect the red plug of the test lead to →| measuring terminal and the black one to the COM terminal.
- ② Set the function selector to →|, then press the SELECT button to select the diode test.
(The sub display shows [diod].)
- ③ Apply the black test pin to the cathode of the diode, and the red one to the anode.
- ④ The display will show the forward voltage drop (forward biased).

*Forward biased voltage drop for a good silicon diode is between 0.400 V to 0.900 V. A reading higher than that indicates a defective diode. A zero (or close to) reading indicates a defective diode (shorted). An OL indicates a defective diode (open).

- ⑤ Apply the red test pin to the cathode of the diode, and the black one to the anode.

*A reading [OL] for reverse biased voltage drop indicates the diode is good. Any other readings indicate the diode is defective (resistive or shorted).

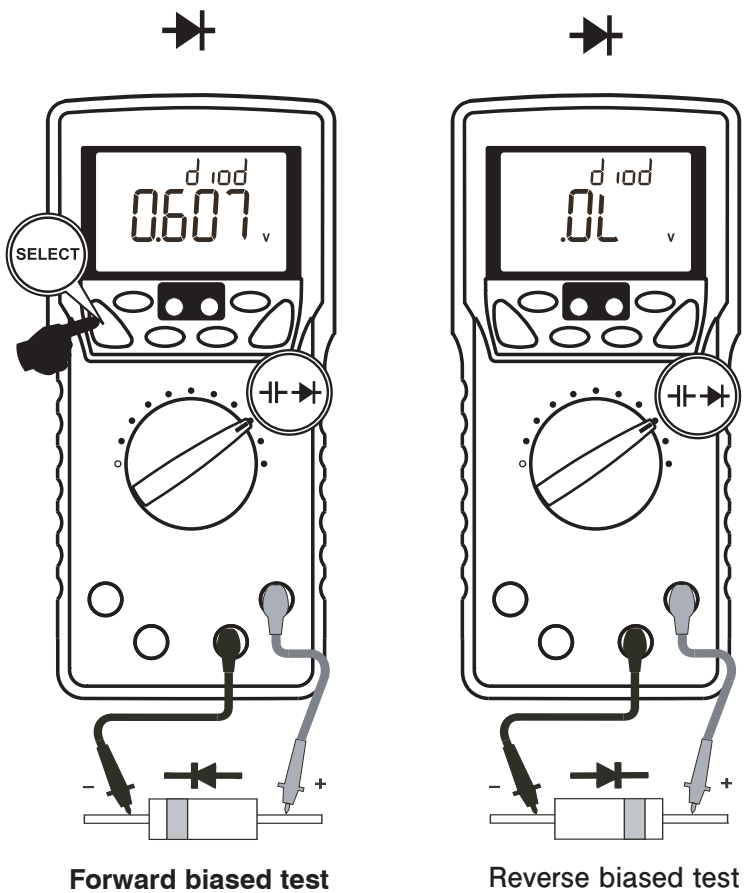

Note:

- Open circuit voltage between the measuring terminals: <3.5 Vdc
- Test current: 0.4 mA (typical)
- Diode test function does not show the bar graph.

5-10 $\left[\frac{A}{mA} \right]$, $\left[\frac{\mu A}{\mu A} \right]$, $\left[\frac{A}{A} \right]$, $\left[\frac{Hz}{Hz} \right]$

- DC current (mA, μ A, A) measurement
- AC current (mA, μ A, A) / Frequency (Hz) simultaneous measurement
- DC current (mA, μ A, A) / AC current (mA, μ A, A) simultaneous measurement
- DC+AC current (mA, μ A, A) / AC current (mA, μ A, A) simultaneous measurement

WARNING

1. Do not apply any voltage to the measuring terminals.
2. Be sure to connect the meter in series with the load object.
3. Do not apply any input exceeding the max. rated current.
4. First turn off the circuit to measure, then cut the part. Connect the test leads of the meter properly in series with the circuit.

Correct way

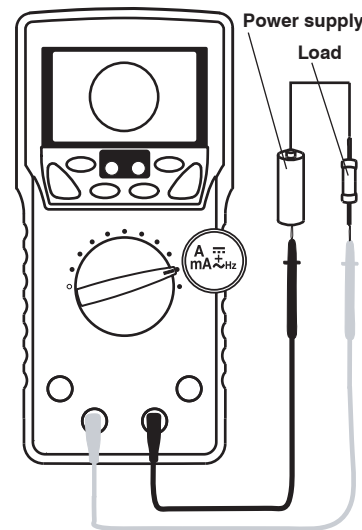

Wrong way

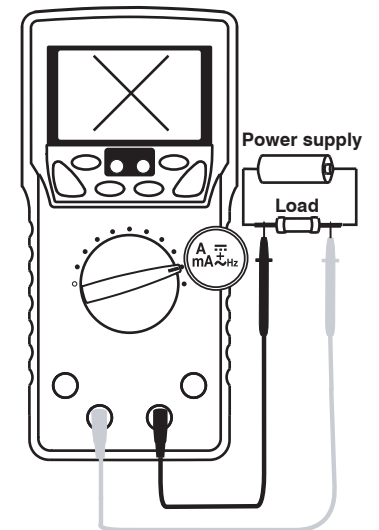

5-10-1 Current (mA/μA) measurement

(\bar{A} , \tilde{A} , $\overline{\bar{A}}$, $\overline{\tilde{A}}$, $\overline{\mu A}$, $\overline{\mu \tilde{A}}$ Max. rated input current 600 mA dc/ac)

1) What to measure

- \bar{A} , $\overline{\bar{A}}$ (DC current): DC circuit current
- \tilde{A} , $\overline{\tilde{A}}$ (AC current): AC circuit current
- $\overline{\bar{A}}/\overline{\tilde{A}}$, $\overline{\mu A}/\overline{\mu \tilde{A}}$ (DC current component/AC current component)
- $\overline{\bar{A}}/\overline{\tilde{A}}$, $\overline{\mu A}/\overline{\mu \tilde{A}}$ (DC/AC superimposed signal current/AC current component)
- Hz (Frequency): Measuring current frequency

2) Measuring ranges

mA : 60.00 mA and 600.0 mA

μA : 600.0 μA and 6000 μA

3) Measuring procedure

- ① Set the function selector to $\overline{\bar{A}}_{\text{Hz}}$ or $\overline{\mu A}_{\text{Hz}}$, then press the SELECT button to select [\bar{A}], [\bar{A}/\tilde{A}], [$\overline{\bar{A}}/\overline{\tilde{A}}$], [\tilde{A}/Hz] for mA range, or select [$\mu \bar{A}$], [$\mu \bar{A}/\mu \tilde{A}$], [$\overline{\mu A}/\overline{\mu \tilde{A}}$], [$\mu \tilde{A}/\text{Hz}$] for μA range.
- ② Connect the red plug of the test lead to mA μA measuring terminal and the black one to the COM terminal.
- ③ Connect the test pins (red and black) in series with the circuit to measure.
 - \bar{A} , $\overline{\bar{A}}$: Connect the black test pin to the lower electric potential side of the circuit to measure, and the red test pin to the higher electric potential side in series with the object.
 - $\tilde{A}/\overline{\tilde{A}}$, $\overline{\mu A}/\overline{\mu \tilde{A}}$: Connect the test pins (red and black) in series with the circuit to measure.
- ④ Read the display.

Note:

Measuring Range	Frequency (Hz) Input sensitivity(Sine wave)	Frequency range
600.0 μA	60 μA	15.00 Hz ~ 3.000 kHz
6000 μA	600 μA	
60.00 mA	40 mA	
600.0 mA	60 mA	

5-10-2 Current (A) measurement

(\bar{A} , \tilde{A} , $\overline{\bar{A}}$ Max. rated input current AC 10 A dc/ac)

1) What to measure

- \bar{A} (DC current): DC circuit current
- \tilde{A} (AC current): AC circuit current
- \bar{A}/\tilde{A} (DC current component / AC current component)
- $\overline{\bar{A}}/\overline{\tilde{A}}$ (DC/AC superimposed signal current / AC current component)
- Hz (Frequency): Measuring current frequency

2) Measuring ranges

6.000 A and 10.00 A

3) Measuring procedure

- ① Set the function selector to $\overline{\bar{A}}_{\text{Hz}}$, and press the SELECT button to select a display style from [\bar{A}], [\bar{A}/\tilde{A}], [$\overline{\bar{A}}/\overline{\tilde{A}}$], and [\tilde{A}/Hz].
- ② Connect the red plug of the test lead to **A** measuring terminal and the black one to the COM terminal.
- ③ Connect the test pins (red and black) in series with the circuit to measure.
 - \bar{A} : Connect the black test pin to the lower electric potential side of the circuit to measure, and the red test pin to the higher electric potential side in series with the object.
 - $\tilde{A}/\overline{\tilde{A}}$: Connect the test pins (red and black) in series with the circuit to measure.
- ④ Read the display.

$\mu\bar{A}$

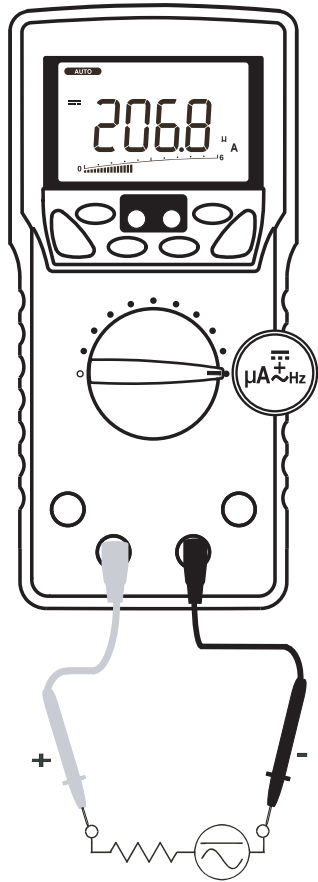

$\mu\bar{A} / \mu\tilde{A}$

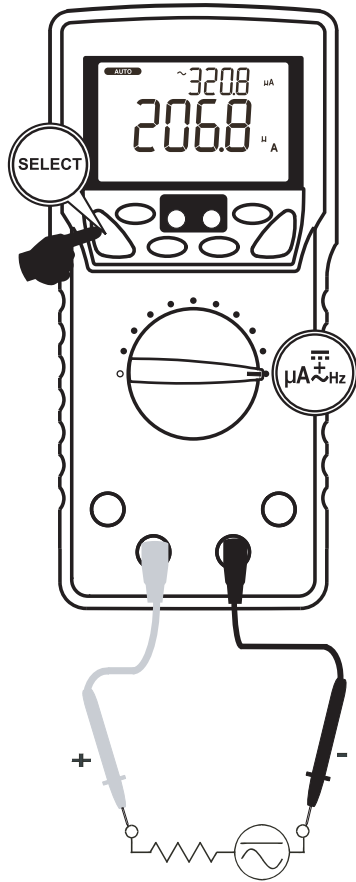

$\mu\bar{A} / \mu\tilde{A}$

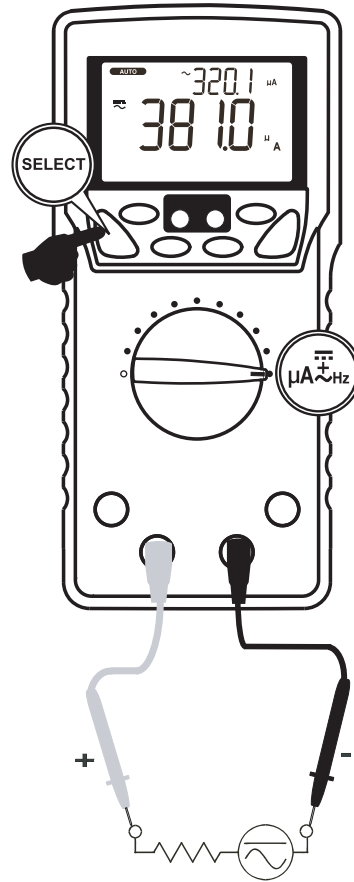

$\mu\tilde{A} / \text{Hz}$

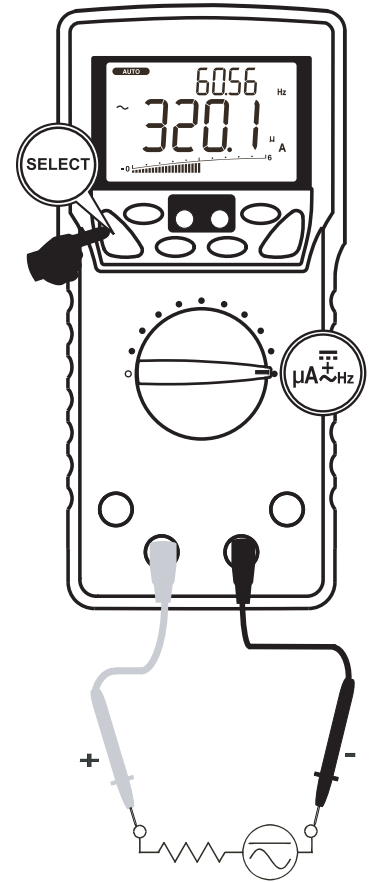

m \tilde{A} / Hz

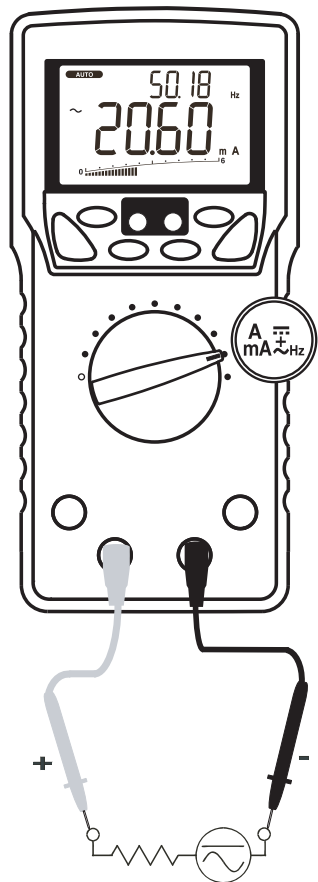

\tilde{A} / Hz

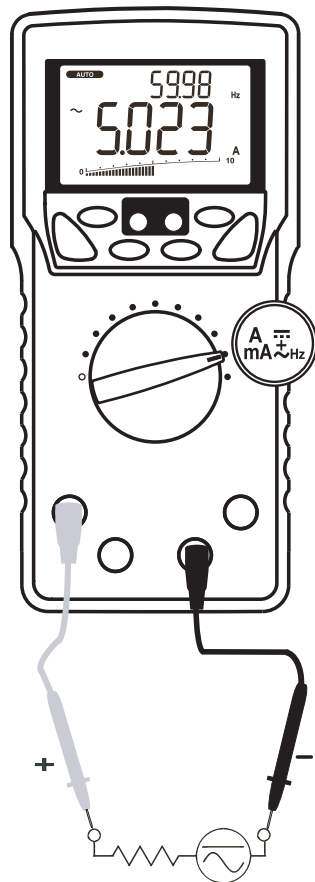

Note:

- > 6 A: Cool down more than 3 minutes after measuring 1 minute.
- < 6 A Continuable

Measuring range	Frequency (Hz) Input sensitivity (Sine wave)	Frequency range
6.000 A	4 A	15.00 Hz ~ 3.000 kHz
10.00 A	7 A	

5-11 Measurements with Optional Products

⚠ WARNING

1. Do not apply any input exceeding max. rated input for the separately available accessories.
2. Do not switch the function selector while measuring.

⚠ CAUTION

1. To make measurements of consumption current for home appliances using a current probe, use a line separator as shown in the drawing below.

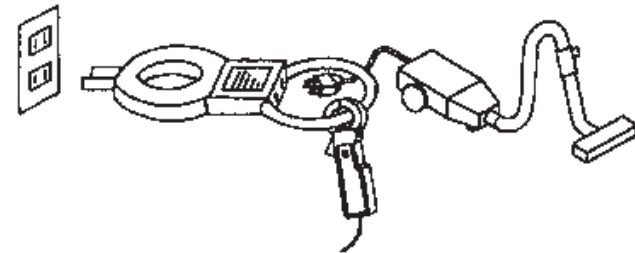

2. Overall accuracy is calculated using the total of each probe's accuracy.

5-11-1 AC flexible clamp sensor: CL3000
(Max. measurable current 3000 A ac)

- 1) What to measure
50/60 Hz sine wave current such as consumption current of home appliances, current of power supply equipments, and etc.
- 2) Measuring ranges
30 A, 300 A, and 3000 A
- 3) Measuring procedure
 - ① Connect the red plug of the current probe to the V measuring terminal and the black one to the COM terminal.
 - ② Set the function selector to Hz \tilde{V} , then press the SELECT button to select \tilde{V} /Hz.
 - ③ Press the RANGE button to set the 9.999 V range.
 - ④ Set the range selector knob on the current probe to the 30 A, 300 A, or 3000 A range.
 - ⑤ Clamp the conductor under test with the flexible current probe.
 - ⑥ Multiply the reading by 10 for 30 A range, by 100 for 300 A range, and by 1000 for 3000 A range respectively, and read in units of A (amps).

Note:

- Current exceeding 30 A, 300 A, or 3000 A cannot be measured. (Do not measure such high current even though the display works.)
- Try to put the conductor under test in the center of the flexible current probe as possible.

5-11-2 Clamp probe: CL-22AD
(Max. measurable current 200 A dc/ac)

- 1) What to measure
ACA: 50/60 Hz sine wave current such as consumption current of home appliances, current of power supply equipments, and etc.
DCA: Current of automotive electric circuits, consumption current of DC equipments, etc.
- 2) Measuring ranges
20 A and 200 A
- 3) Measuring procedure
 - ① Connect the red plug of the current probe to the V measuring terminal and the black one to the COM terminal.
 - ② To make DC current measurement (DCA), set the function selector to \overline{mV} and press the SELECT button to select \overline{mV} , then press the RANGE button to set 600.0 mV range. To make AC current measurement (ACA), set the function selector to Hz \tilde{mV} and press the SELECT button to select \tilde{mV} /Hz, then press the RANGE button to set 600.0 mV range.
 - ③ Set the range selector knob on the current probe to the 20 A range or 200 A range.
*Before making DC current measurement, turn the Center Adjuster knob to make the reading zero.
 - ④ Open the clamp jaws of the clamp probe and clamp the wire to measure.
 - ⑤ Multiply the reading by 0.1 for 20 A range, and read the display directly for 200 A range.

Note:

- Current exceeding 20 A or 200 A cannot be measured. (Do not measure such high current even though the display works.)
- Try to put the wire to measure in the center of the clamp jaws as possible.

5-11-3 DC Clamp probe: CL-33D

(Max. measurable current 300 Adc)

- 1) What to measure
Current of automotive electric circuits, consumption current of DC equipments, etc.
- 2) Measuring ranges
30 A and 300 A
- 3) Measuring procedure
 - ① Connect the red plug of the current probe to the V measuring terminal and the black one to the COM terminal.
 - ② Set the function selector to $\overline{D\%}$ \overline{mV} and press the SELECT button to select \overline{mV} , then press the RANGE button to set 600.0 mV range.
 - ③ Set the range selector knob on the current probe to the 30 A range or 300 A range.
*Before making DC current measurement, turn the Center Adjuster knob to make the reading zero.
 - ④ Open the clamp jaws of the clamp probe and clamp the wire to measure.
 - ⑤ Multiply the reading by 0.1 for 30 A range, and read the display directly for 300 A range.

Note:

- Current exceeding 30 A or 300 A cannot be measured.
(Do not measure such high current even though the display works.)
- Try to put the wire to measure in the center of the clamp jaws as possible.

5-11-4 Temperature probe: T-300PC

- 1) What to measure
Temperature of liquid, solids, gas, and etc.
Note:
To make temperature measurement, connect the temperature probe to the PC720M connected to the PC on which sanwa's software PC Link7 is installed and running.
- 2) Measuring range
-50 ~ 300 °C
DMM range: 6 k Ω
- 3) Measuring procedure
 - ① Connect the red plug of the temperature probe to $\overline{\Omega}$ measuring terminal and the black one to the COM terminal.
 - ② Set the function selector to $\overline{\Omega}$ and press the SELECT button to select [Ω].
 - ③ Press the RANGE HOLD button to set 6 k Ω .
 - ④ Apply the thermocouple to the object to measure.
 - ⑤ Read the measurements on the information window of the PC Link7.
 - ⑥ Remove the thermocouple from the object.

5-11-5 Other separately available products

The meter also works with the following separately-available products.
LS11, K-AD, CL124, CL140, K-8-250, K-8-300, K-8-500, K-8-650, K-250PC/K-250CD, and K-8-800

[6] MAINTENANCE

⚠ WARNING

1. The followings are important to safety. Read this manual throughly to maintain the instrument.
2. Calibrate and inspect the instrument at least once a year to ensure safety and maintain its accuracy.

6-1 Simple Examination

- 1) Appearance
 - Check for damaged appearance by dropping down and so on.
- 2) Test leads
 - Check for loose contacts between the measuring terminals and test lead plugs.
 - Check for damaged test lead wires.
 - Check for exposed core wire anywhere on the test leads.

If you find any problem on the above items, stop using immediately and ask us to repair it.

Check for the test leads without breaking wires, referring to the section 5-1.

6-2 Calibration

If self-diagnostic message “rE-O” is being displayed while powering on, the meter is re-organizing internal parameters. Do not turn off the meter, and it will be back to normal measurement shortly. However, if self-diagnostic message “C_Er” is being displayed while powering on, some meter ranges might be largely out of specifications. To avoid misleading measurements, stop using the meter and send it for re-calibration. Refer to the AFTER-SALE SERVICE section for obtaining warranty or repairing service.

For requesting calibration and inspection, contact an authorized agent/distribution service provider, listed in our website. See section 7-3.

6-3 Battery and Fuse Replacement

⚠ WARNING

1. Do not open the rear case with live measuring terminals to avoid electric shock. Also, make sure the meter power is OFF, before starting replacement.
2. Be sure to use the specified fuse. Neither use unspecified fuse nor short-circuit the fuse holder.

Pre-installed battery

Since the pre-installed battery is for monitoring, it may not be durable as typically expected.

*The purpose of the battery for monitoring is to check for the functions and performances of the product.

Replacement procedure

- ① Remove the holster and loosen the Philips-head screw fixing the battery door using appropriate screw driver.
- ② Remove the battery door and replace the battery or fuse with new one.
- ③ Re-fasten the screw and set the holster again.

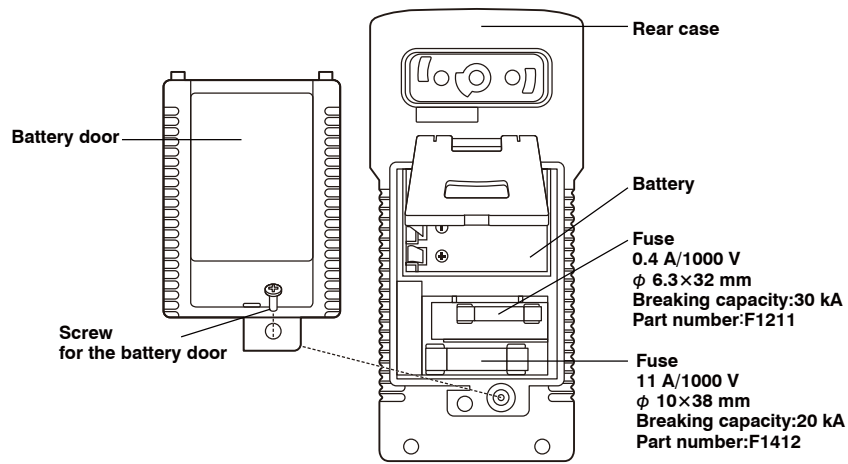

6-4 Storage

⚠ CAUTION

1. The panel and case are not resistant to volatile solvents. Do not wipe out with solvents or isopropyl alcohol. Clean the instrument up with a dry soft cloth.
2. The panel and case are not resistant to heat. Keep it away from heat-generating devices such as solder irons.
3. Do not save the instrument into vibratory places or where the instrument may fall off.
4. Do not expose the instrument to direct sunlight and do not save it into any places with extreme temperature, humid, or condensation.
5. Remove the battery for saving the instrument over a long period of time.

Save the instrument into an appropriate place, according to the precautions above.

[7] AFTER-SALE SERVICE

7-1 Warranty and Provision

Sanwa offers comprehensive warranty services to its end-users and to its product resellers. Under Sanwa's general warranty policy, each instrument is warranted to be free from defects in workmanship or material under normal use for the period of one (1) year from the date of purchase.

This warranty policy is valid within the country of purchase only, and applied only to the product purchased from Sanwa authorized agent or distributor.

Sanwa reserves the right to inspect all warranty claims to determine the extent to which the warranty policy shall apply. This warranty shall not apply to disposables batteries, or any product or parts, which have been subject to one of the following causes:

1. A failure due to improper handling or use that deviates from the instruction manual.
2. A failure due to inadequate repair or modification by people other than Sanwa service personnel.
3. A failure due to causes not attributable to this product such as fire, flood and other natural disaster.
4. Non-operation due to a discharged battery.
5. A failure or damage due to transportation, relocation or dropping after the purchase.

7-2 Repair

Customers are asked to provide the following information when requesting services:

1. Customer name, address, and contact information
2. Description of problem
3. Description of product configuration
4. Model Number
5. Product Serial Number
6. Proof of Date-of-Purchase
7. Where you purchased the product

Please contact Sanwa authorized agent / distributor / service

provider, listed in our website, in your country with above information. An instrument sent to Sanwa / agent / distributor without above information will be returned to the customer.

Note:

- 1) Prior to requesting repair, please check the following:
Capacity of the built-in battery, polarity of installation and discontinuity of the test leads.
- 2) Repair during the warranty period:
The failed meter will be repaired in accordance with the conditions stipulated in 7-1 Warranty and Provision.
- 3) Repair after the warranty period has expired:
In some cases, repair and transportation cost may become higher than the price of the product. Please contact Sanwa authorized agent / service provider in advance.
The minimum retention period of service functional parts is 6 years after the discontinuation of manufacture. This retention period is the repair warranty period. Please note, however, if such functional parts become unavailable for reasons of discontinuation of manufacture, etc., the retention period may become shorter accordingly.
- 4) Precautions when sending the product to be repaired:
To ensure the safety of the product during transportation, place the product in a box that is larger than the product 5 times or more in volume and fill cushion materials fully and then clearly mark "Repair Product Enclosed" on the box surface. The cost of sending and returning the product shall be borne by the customer.

7-3 SANWA web site

<http://www.sanwa-meter.co.jp>
E-mail: exp_sales@sanwa-meter.co.jp

[8] SPECIFICATIONS

8-1 General Specifications

Operation method	Delta-sigma modulation	
LCD display	Main display	9,999 counts: DCV, ACA, Logic-Level Frequency (Hz), nS, Duty Cycle, and Temperature (T1, T2) 6,000 counts: DCmV, ACmV, Resistance, Continuity, Capacitance, DCA, DCmA, DCμA, ACA, ACmA, and ACμA 2,000 counts: Diode Bar graph: Up to 41 segments
	Sub display	9,999 counts: ACV, Frequency (Hz), and Temperature (T2) 6,000 counts: ACmV, ACA, ACmA, and ACμA
Over-range indication	Over-range input turns on "OL" indicator at the numeric part.	
Sampling rate	Main/Sub disp.	5 times / sec.
	Bar graph	60 times / sec.
Low battery indication	Decreasing the internal battery voltage to approx. 7 V turns the battery mark on.	
Operating conditions	Altitude: < 2,000 m Pollution degree: II	
Operating temperature/humidity	5 °C to 40 °C : non-condensing 5 °C to 31 °C : 80 %RH (Max.) 31 °C to 40 °C : decreasing 80 % to 50 % linearly	
Storage temperature/humidity	-10 °C to 40 °C : 80 %RH (Max.) non-condensing (with battery removed) 40 °C to 50 °C : 70 %RH (Max.) non-condensing (Remove the battery, if the equipment is not going to be used for a long time.)	
Temperature coefficient	0.15 x (accuracy @23±5 °C) / °C @ (0 °C to 18 °C or 28 °C to 40 °C) For the AutoΩ·V function (Resistance Ω), 0.5 x (accuracy @23±5 °C) / °C @ (0 °C to 18 °C or 28 °C to 40 °C)	

Power source	Single alkaline 9 V battery 6LR61 (IEC6LF22, NEDA1604A)	
AC sensing method	True RMS	
Auto Power Saving	Approx. 30 minutes after the last operation	
Safety Compliances	IEC61010-1, IEC61010-2-030, IEC61010-2-033, IEC61010-031	
		Category II for 1000 V ac and dc
	mA μA	Category III for 600 V ac and dc
	A	
EMC	Meets EN61326-1:2006 In an RF field of 3 V/m: Capacitance function is not specified Other function ranges: Total Accuracy = ± (Specified% rdg + 100 digits) Performance above 3 V/m is not specified	
Dimensions	without holster	Approx. L175 mm × W80 mm × H40 mm
	with holster	Approx. L184 mm × W86 mm × H52 mm
Mass	without holster	Approx. 360 g
	with holster	Approx. 430 g
Power consumption	Approx. 48 mW / approx. 0.45 mW (Auto Power Saving)	
Battery life	Approx. 100 hours (DCV measurement)	
Accessories	Test leads (TL-23a), Holster (H-700) with light shielding magnet cap, K-type thermocouple (K-250PC), Instruction manual	

OVERVOLTAGE CATEGORY

- Equipment of CAT II: Primary cable runs of power-consuming equipments from a wall socket.
- Equipment of CAT III: Primary cable runs of equipments directly connected to a distribution board and cable runs from a distribution board to wall sockets.
- Equipment of CAT IV: Cable runs from an incoming line to a distribution board.

8-2 Measuring Range and Accuracy

Accuracy: ± (% rdg + dgt)
rdg: reading, dgt: least significant digit
Temperature: 23 °C ± 5 °C, Humidity: < 75 % R.H.
True RMS voltage and current accuracies are specified from 10 % to 100 % of each range otherwise specified.
Crest factor: < 2:1 (at full scale), < 4:1 (at half scale)

DC Voltage DCV

DC voltage for single display

Range	Accuracy
60.00 mV	± (0.12 % rdg + 2 dgt)
600.0 mV	± (0.06 % rdg + 2 dgt)
9.999 V, 99.99 V, 999.9 V	± (0.08 % rdg + 2 dgt)

DC Voltage/AC Voltage for dual display

Range	Accuracy
60.00 mV, 600.0 mV 9.999 V, 99.99 V, 999.9 V	± (0.7 % rdg + 6 dgt)

Input impedance: 10 MΩ, 80 pF nominal
(130 pF nominal for 600.0 mV & 60.00 mV range)

For AutoΩ·V function

Range	Accuracy
9.999 V, 99.99 V, 999.9 V	± (0.5 % rdg + 3 dgt)

Lo-Z DCV threshold level:

< -1.0 VDC or +1.5 VDC < nominal

Lo-Z DCV input impedance:

Initial: Approx. 3.0 kΩ, 270 pF nominal; If a reading is over 50 V (typical), the input impedance goes up abruptly.

The followings are the final impedances by readings:

- 18 kΩ for 100 V
- 125 kΩ for 300 V
- 320 kΩ for 600 V
- 500 kΩ for 1000 V

AC Voltage ACV and DC+AC Voltage DC+AC V

AC voltage/ Frequency for dual display

Range	Accuracy
50 Hz ~ 60 Hz	
60.00 mV, 600.0 mV, 9.999 V, 99.99 V, 999.9 V	± (0.5 % rdg + 3 dgt)
40 Hz ~ 500 Hz (Except 50 Hz ~ 60 Hz)	
60.00 mV, 600.0 mV	± (0.8 % rdg + 4 dgt)
9.999 V, 99.99 V	± (1.0 % rdg + 4 dgt)
999.9 V	± (2.0 % rdg + 4 dgt)
500 Hz ~ 1 kHz	
60.00 mV, 600.0 mV	± (2.0 % rdg + 3 dgt)
9.999 V, 99.99 V	± (1.0 % rdg + 4 dgt)
999.9 V	± (2.0 % rdg + 4 dgt)
1 kHz ~ 3 kHz	
60.00 mV, 600.0 mV	± (2.0 % rdg + 3 dgt)
9.999 V, 99.99 V, 999.9 V	± (3.0 % rdg + 4 dgt)
3 kHz ~ 20 kHz	
60.00 mV *, 600.0 mV *	± (2.0 % rdg + 3 dgt)
9.999 V **, 99.99 V	±3 dB
999.9 V	Unspecified

Input impedance: 10 MΩ, 80 pF nominal

(130 pF nominal for 600.0 mV & 60.00 mV range)

Residual reading: Less than 5 digits with test leads shorted

* Specified from 30 % to 100 % of the range

** 3 kHz to 15 kHz

DC Voltage/AC Voltage, DC+AC Voltage/AC Voltage for dual display

Range	Accuracy
50 Hz ~ 60 Hz	
60.00 mV, 600.0 mV	± (0.7 % rdg + 6 dgt)
9.999 V, 99.99 V, 999.9 V	
40 Hz ~ 1 kHz (Except 50 Hz ~ 60 Hz)	
60.00 mV, 600.0 mV	± (1.0 % rdg + 6 dgt)
9.999 V, 99.99 V, 999.9 V	± (2.2 % rdg + 6 dgt)
1 kHz ~ 20 kHz	
60.00 mV, 600.0 mV ¹⁾	± (2.2 % rdg + 6 dgt)
9.999 V ²⁾ , 99.99 V	±3 dB
999.9 V	Un specified

Input impedance: 10 MΩ, 80 pF nominal

(130 pF nominal for 600.0 mV & 60.00 mV range)

1) Specified from 30 % to 100 % of the range

2) 3 kHz ~ 15 kHz

For AutoΩ·V function

Range	Accuracy
50 Hz to 60 Hz	
9.999 V, 99.99 V, 999.9 V	± (1.0 % rdg + 4 dgt)

Lo-Z ACV threshold level:

3 Vac < (50/60 Hz) nominal

Lo-Z ACV input impedance:

Initial: Approx. 3.0 kΩ, 270 pF nominal; If a reading is over 50 V (typical), the input impedance goes up abruptly.

The followings are the final impedances by readings:

18 kΩ for 100 V

125 kΩ for 300 V

320 kΩ for 600 V

460 kΩ for 1000 V

DC current

Range	Accuracy	Input resistance**
600.0 μ A	$\pm (0.2 \% \text{ rdg} + 4 \text{ dgt})$	Approx. 83 Ω
6000 μ A		
60.00 mA		Approx. 1 Ω
600.0 mA		
6.000 A		Approx. 0.005 Ω
10.00 A*		

* > 6 A: Cool down more than 3 minutes after measuring 1 minute.
 < 6 A Continuable

**Fusing resistor not included

AC current ACA and DC+AC current DC+AC A

Range	Accuracy	Input resistance**
50 Hz ~ 60 Hz		
600.0 μ A	$\pm (0.6 \% \text{ rdg} + 3 \text{ dgt})$	Approx. 83 Ω
6000 μ A		
60.00 mA	$\pm (1.0 \% \text{ rdg} + 3 \text{ dgt})$	Approx. 1 Ω
600.0 mA		
6.000 A 10.00 A*	$\pm (0.8 \% \text{ rdg} + 6 \text{ dgt})$	Approx. 0.05 Ω
40 Hz ~ 1 kHz (Except 50 Hz ~ 60 Hz)		
600.0 μ A 6000 μ A	$\pm (0.8 \% \text{ rdg} + 4 \text{ dgt})$	Approx. 83 Ω
60.00 mA		
600.0 mA	$\pm (1.0 \% \text{ rdg} + 4 \text{ dgt})$	Approx. 1 Ω
6.000 A 10.00 A*	$\pm (0.8 \% \text{ rdg} + 6 \text{ dgt})$	

* > 6 A: Cool down more than 3 minutes after measuring 1 minute.
 < 6 A Continuable

**Fusing resistor not included

Resistance (Ω)

Range	Accuracy
600.0 Ω , 6.000 k Ω , 60.00 k Ω , 600.0 k Ω	$\pm (0.1 \% \text{ rdg} + 3 \text{ dgt})$
6.000 M Ω	$\pm (0.4 \% \text{ rdg} + 3 \text{ dgt})$
60.00 M Ω	$\pm (1.5 \% \text{ rdg} + 5 \text{ dgt})$
99.99 nS	$\pm (0.8 \% \text{ rdg} + 10 \text{ dgt})$

Open circuit voltage: <1.2 Vdc (<1.0 Vdc for 60.00 M Ω range)

For Auto Ω ·V function (Resistance)

Range	Accuracy
600.0 Ω , 6.000 k Ω 60.00 k Ω , 600.0 k Ω	$\pm (0.5 \% \text{ rdg} + 4 \text{ dgt})$
6.000 M Ω	$\pm (0.8 \% \text{ rdg} + 3 \text{ dgt})$
60.00 M Ω	$\pm (2.0 \% \text{ rdg} + 5 \text{ dgt})$

Temperature coefficient:

0.5 x (accuracy @23 \pm 5 $^{\circ}$ C) / $^{\circ}$ C @ (0 $^{\circ}$ C to 18 $^{\circ}$ C or 28 $^{\circ}$ C to 40 $^{\circ}$ C)

Open circuit voltage: <1.2 Vdc (<1.0 Vdc for 60.00 M Ω range)

Temp ($^{\circ}$ C & $^{\circ}$ F)**

Range	Accuracy*
-50 $^{\circ}$ C ~ 1000 $^{\circ}$ C	$\pm (0.3 \% \text{ rdg} + 2 \text{ dgt})$
-58 $^{\circ}$ F ~ 1832 $^{\circ}$ F	$\pm (0.3 \% \text{ rdg} + 5 \text{ dgt})$

* Accuracy with K-type thermocouple K-type thermocouple range and accuracy not included

**Cool down more than 30 minutes after measuring DCA or ACA.

Frequency (Hz)

Measuring ranges	Input sensitivity*	Frequency ranges
60.00 mV	40 mV	15.00 Hz to 50.00 kHz
600.0 mV	60 mV	
9.999 V	2.5 V	15.00 Hz to 10.00 kHz
99.99 V	25 V	
999.9 V	100 V	
600.0 μ A	60 μ A	15.00 Hz to 3.000 kHz
6000 μ A	600 μ A	
60.00 mA	40 mA	
600.0 mA	60 mA	
6.000 A	4 A	
10.00 A	7 A	

Accuracy: $\pm(0.04\% \text{ rdg} + 4 \text{ dgt})$

*Specified based on sine wave RMS

Logic level frequency (μ Hz) and Duty cycle (D%)

DCmV function	Range	Accuracy*
Frequency	5.000 Hz to 1.000 MHz	$\pm (0.03\% \text{rdg} + 4 \text{ dgt})$
Duty cycle	0.00 % to 100.0 %	$\pm (3 \text{ dgt/kHz} + 2 \text{ dgt})$ **

* Sensitivity: 2.5 Vp (Square wave) for 3 V and 5 V logic family

** Frequency range: 5 Hz to 10 kHz

Capacitance $\text{--}\text{||}\text{--}$

Range	Accuracy*
60.00 nF, 600.0 nF***	$\pm (0.8\% \text{ rdg} + 3 \text{ dgt})$
6.000 μ F	$\pm (1.0\% \text{ rdg} + 3 \text{ dgt})$
60.00 μ F	$\pm (2.0\% \text{ rdg} + 3 \text{ dgt})$
600.0 μ F **	$\pm (3.5\% \text{ rdg} + 5 \text{ dgt})$
6.000 mF **	$\pm (5.0\% \text{ rdg} + 5 \text{ dgt})$
25.00 mF **	$\pm (6.5\% \text{ rdg} + 5 \text{ dgt})$

* Accuracies with film capacitor or better

** In manual-ranging mode, measurements not specified below 50.0 μ F, 0.54 mF and 5.4 mF for 600.0 μ F, 6.000 mF and 25.00 mF ranges respectively

*** In manual-ranging mode, the accuracy for measurements below 5.4 nF for 60.00 nF range and 54 nF for 600.0 nF range is: $\pm(0.8\% \text{ rdg} + 6 \text{ dgt})$

Diode test \rightarrow

Range	Accuracy	Test current	Open circuit voltage
2.000 V	$\pm (1\% \text{ rdg} + 1 \text{ dgt})$	Approx. 0.4 mA	< 3.5 V

Continuity check $\bullet\text{--}\text{||}\text{--}\bullet$)

Threshold level: 20 Ω to 300 Ω

Response time: < 100 μ s

Max/Min (with capture mode)

Accuracy: $\pm(\text{Specified \% rdg} + 250 \text{ dgt})$ in each function

Sampling time: Approx. 1 ms

Max/Min (with recording mode)

Accuracy: $\pm(\text{Specified \% rdg} + 10 \text{ dgt})$ in each function

(for changes > 100 ms in duration in voltage or current measurement)

How to calculate an accuracy

Example) DC voltage measurement (DC mV)

True value: 100.0 [mV]

Range accuracy: $\pm(0.06 \% \text{rdg} + 2 \text{ dgt})$ in the 600.0 mV range

Measuring error: $\pm(100.0 \text{ [mV]} \times 0.06 \% \text{ rdg} + 2 \text{ dgt})$

$\div \pm 0.3 \text{ [mV]}$

Calculation: 100.0 [mV] $\pm 0.3 \text{ [mV]}$

Reading: 099.7 [mV] to 100.3 [mV]

* 2 dgt in the 600.0 mV range corresponds to 0.2 mV.

The product specifications and its appearance described in this manual are subject to change without prior notice for improvements or other reasons.

SANWA®

三和電気計器株式会社

本社=東京都千代田区外神田2-4-4・電波ビル
郵便番号=101-0021・電話=東京(03) 3253-4871(代)
大阪営業所=大阪市浪速区恵美須西2-7-2
郵便番号=556-0003・電話=大阪(06) 6631-7361(代)
SANWA ELECTRIC INSTRUMENT CO.,LTD.
Dempa Bldg., 4-4 Sotokanda2-Chome Chiyoda-Ku,Tokyo,Japan



This manual employs soy ink.

05-1405 5008 6010