

sanwa®



PC773

DIGITAL MULTIMETER

INSTRUCTION MANUAL **CE**

Table of Contents



[1]	SAFETY PRECAUTIONS – Before use, read the following safety precautions.–	
1-1	Explanation of Warning Symbols	1
1-2	Warning Messages for Safe Use.....	1
1-3	Overload Protection Input.....	3
[2]	APPLICATIONS AND FEATURES	
2-1	Applications	4
2-2	Features	4
[3]	NAMES OF COMPONENT UNITS	
3-1	Multimeter	5
3-2	Test Leads	5
3-3	Display.....	6
[4]	DESCRIPTION OF FUNCTIONS	
4-1	Power Switch & Function Switch.....	7
4-2	Measuring Function Selection : SELECT	7
4-3	Data Hold : DATA HOLD	7
4-4	Backlight : BACK LIGHT	7
4-5	Range Hold : RANGE HOLD	8
4-6	Relative Measurement : RELATIVE	8
4-7	Auto Power Off	8
4-8	Battery Low Warning Indication	9
4-9	AC Detection Method	9
4-10	Crest Factor	9
4-11	Connection with PC	10
[5]	MEASURING PROCEDURE	
5-1	Start-up Inspection	12
5-2	DC Voltage Measurement (DCV)	13
5-3	AC Voltage Measurement (ACV)	14
5-4	Resistance Measurement (Ω), Continuity Check (\bullet), Diode Test (\rightarrow)	15
5-5	Capacitance Measurement (HC)	16
5-6	Frequency Measurement (Hz)	17
5-7	Current Measurement (μA / mA / A)	18
5-8	Measurements Using Optional Products	20
[6]	MAINTENANCE	
6-1	Maintenance and Inspection	25
6-2	Calibration and Inspection	25
6-3	Storage	25
6-4	Battery and Fuse Replacement	25
[7]	AFTER-SALE SERVICE	
7-1	Warranty and Provision.....	27
7-2	Repair	27
7-3	SANWA web site	28
[8]	SPECIFICATIONS	
8-1	General Specifications	29
8-2	Measuring Range and Accuracy	30

[1] SAFETY PRECAUTIONS

***Before use, read the following safety precautions.**

This instruction manual explains how to use your digital multimeter PC773. Before use, please read this manual thoroughly to ensure correct and safe use. After reading it, keep it together with the product for reference to it when necessary.

Using the product in a manner not specified in this manual may cause damage to the protection function of the product.

The instructions given under the headings of “WARNING” and “CAUTION” must be followed to prevent accidental **burn** and **electric shock**.

1-1 Explanation of Warning Symbols

The meanings of the symbols used in this manual and attached to the product are as follows:

 : **Very important instructions for safe use.**

- The warning messages are intended to prevent accidents to operating personnel such as burn and electric shock.
- The caution messages are intended to prevent incorrect handling which may damage the product.

 : High voltage hazard

 : Ground

 : Direct current (DC)

Hz: Frequency

 : Alternating current (AC)

 : Capacitor

 : Resistance

 : Fuse

 : Diode

 : Buzzer

 : Double insulation or reinforced insulation

1-2 Warning Messages for Safe Use

WARNING

The following instructions are intended to prevent injury such as burn and electric shock. Be sure to follow them when using the meter:

1. Never use the meter for power lines exceeding 6 kVA.
2. Voltages over 70VDC or 33Vrms AC (46.7V peak) are hazardous to human body. Take care so as not to touch them.
3. Never input signals exceeding the maximum rated input value (see 1-3).

4. Never use the meter for measuring voltages of lines connected to equipment (e.g. motors) that generates induced or surge voltage since it may exceed the maximum allowable overload input.
5. Never use the meter near equipment which generates strong electromagnetic waves or is charged.
6. Never use the meter if the meter or test leads are damaged or broken.
7. Never use the meter with the case or battery lid removed.
8. Be sure to use the fuse of the specified rating and specification.
9. During measurement, do not hold the test pin side of the flange of the test leads.
10. To start measurement, first connect the ground side (black test lead). When disconnecting, the ground side must be disconnected last.
11. During measurement, do not change the meter to another function or range nor replace the plugs to other terminals.
12. Before starting measurement, make sure that the function and range are properly set.
13. Never use the meter when it is wet or with wet hands.
14. Be sure to use the specified type of test leads.
15. Never attempt repair or modification, except for battery and fuse replacement.
16. Inspect the meter at least once a year.
17. This meter is for indoor use only.

 **CAUTION**

To avoid electric shock, always be sure to discharge the high voltage charged in the measured device after measuring insulation resistance.

1-3 Overload Protection Input

The maximum rated input value and overload protection have been established for the input terminals of each function.

Function	Input Terminal	Max. Rated Input Value	Max. Overload Protection Input Value
DCV · ACV · Hz	V/Hz/⎓ Ω/→/·))) · ⎓ and COM	DC/AC1000V	DC/AC 1000 V
Ω/→/·))) · ⎓		⚠ Do not input a voltage or current.	
μA	μA mA and COM	DC/AC 1100 μA ⚠ Do not input a voltage.	315 mA/1000 V fuse Breaking capacity: 30 kA
mA		DC/AC 110 mA ⚠ Do not input a voltage.	
A	11A and COM	DC/AC 11 A ⚠ Do not input a voltage	12 A/1000 V fuse Breaking capacity: 30 kA

[2] APPLICATIONS AND FEATURES

2-1 Applications

This is a digital multimeter designed for measurement in the ranges of CAT. II 1000V and CAT. III 600V. This meter is useful for measuring / analyzing circuits of small communication devices, home electric appliances and batteries within the CAT. III environment.

2-2 Features

- Safety design in compliance with the IEC61010-1. The current terminal is protected with a fuse and safety cap.
- 11000-count full-scale display.
- True RMS sensing for alternating current (AC).
- Continuity confirmed by the buzzer and red LED lamp.
- Eye-friendly large size display.
- Frequency and capacitance measurement functions provided.
- Easy-to-hold design.
- Test probes can be fixed to the body.
- Double molding of elastic elastomer material.
- Maximum resistance measurement resolution 0.01 Ω .
- Maximum DC/AC voltage measurement resolution 0.01 mV.
- Software (PC Link7) and optical-link USB cable optionally available for PC connection and DMM data acquisition.

Classification of overvoltage measurement

Overvoltage measurement classification (CAT. I):

Line on the secondary side on the inside of equipment via a transformer, etc. from the receptacle.

Overvoltage measurement classification (CAT. II):

Line on the primary side of equipment with power cord to be connected to the receptacle.

Overvoltage measurement classification (CAT. III):

Line from the primary side or branch of equipment which directly takes in electricity from a distribution board to the receptacle.

Overvoltage measurement classification (CAT. IV):

Line from the service conductor to the distribution board.

[3] NAMES OF COMPONENT UNITS

3-1 Multimeter

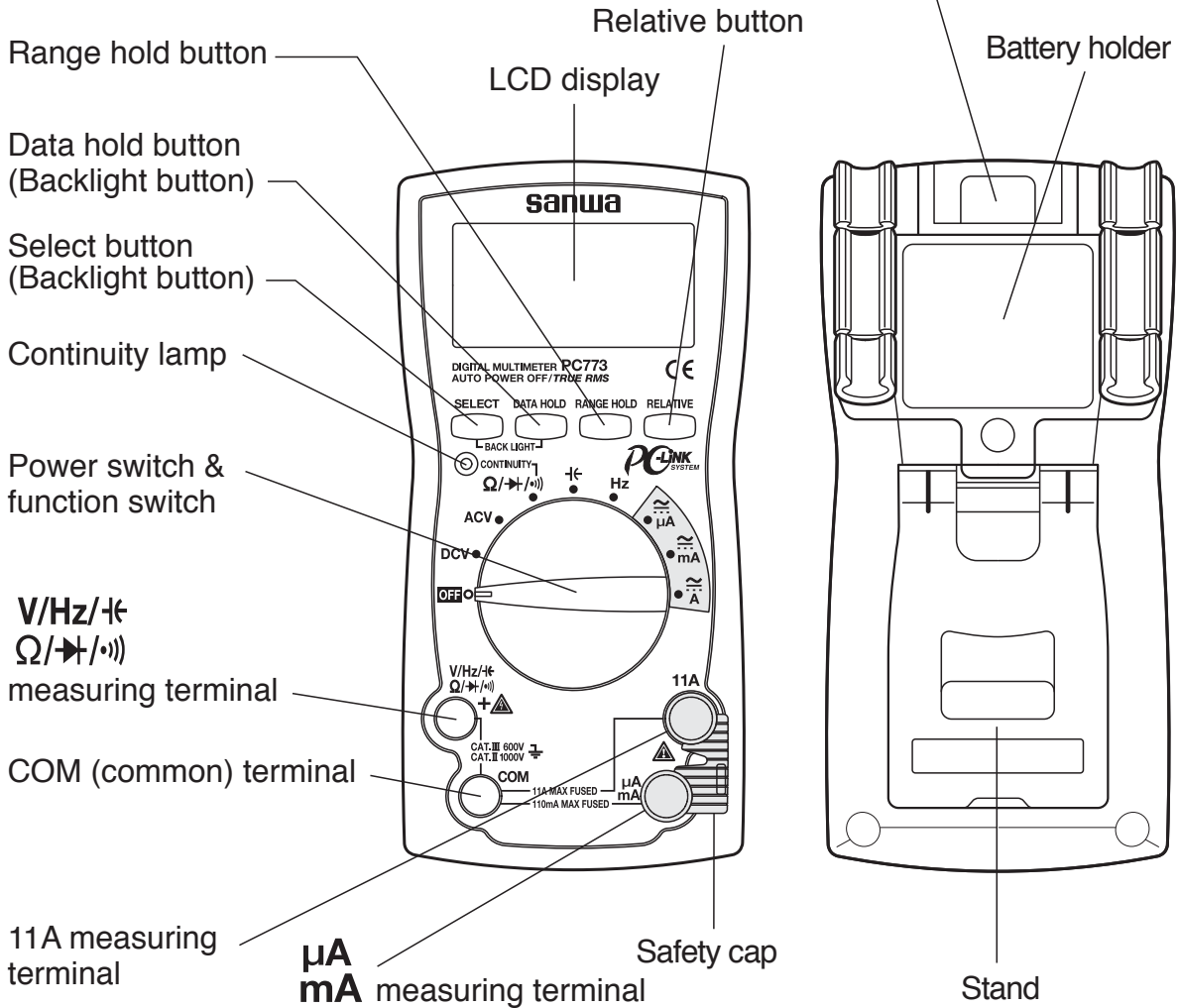

3-2 Test Leads

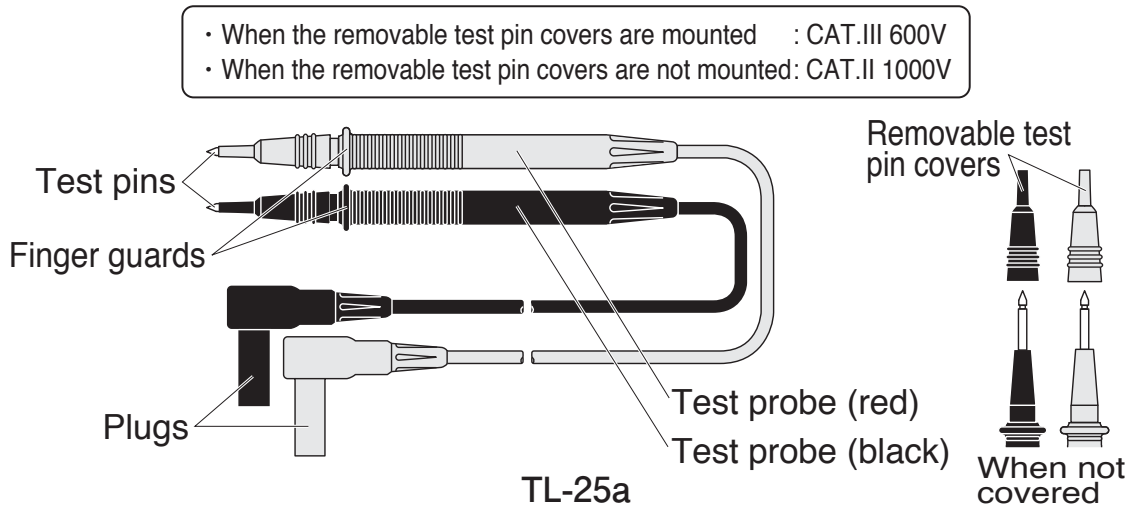

3-3 Display

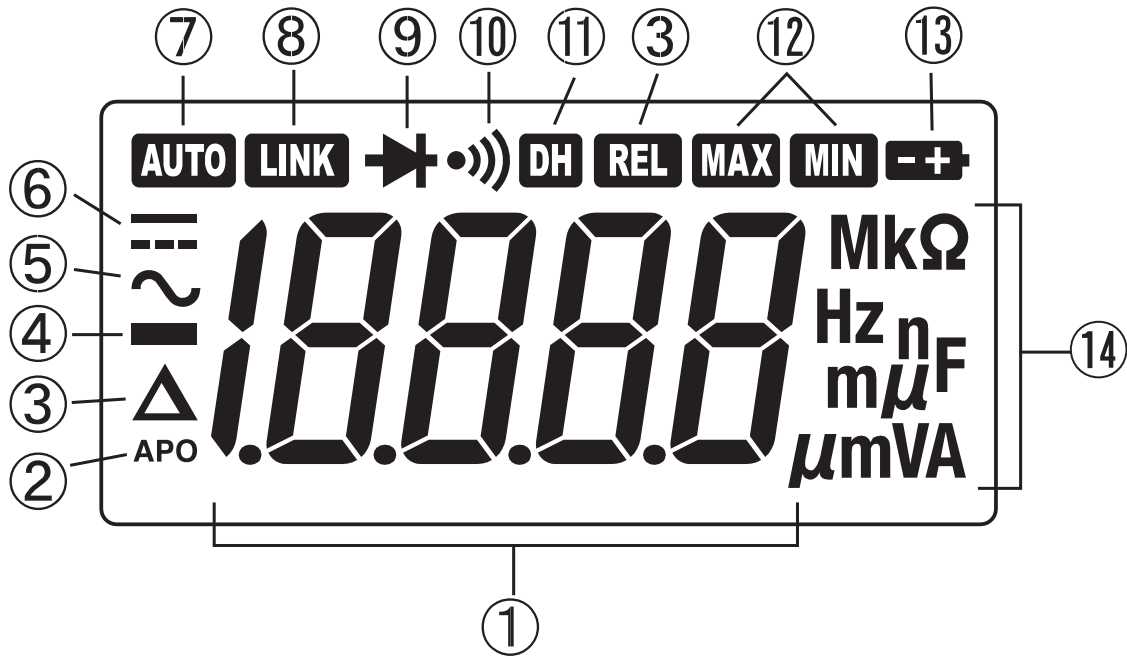

①	Numeral data display
②	Auto power off display
③	Relative mode display
④	Minus polarity display for numeral data
⑤	AC measurement function display
⑥	DC measurement function display
⑦	Auto range mode display
⑧	Optical data output display
⑨	Testing diode display
⑩	Checking continuity display
⑪	Data hold display
⑫	Not used with this meter
⑬	Battery discharge warning display
⑭	Measurement unit display

[4] DESCRIPTION OF FUNCTIONS

4-1 Power Switch & Function Switch

Turn this switch to turn on and off the power and select a measuring function.

4-2 Measuring Function Selection: SELECT

When the **SELECT** button is pressed, the functions change as follows:

- $\Omega/\rightarrow/\rightarrow$ position: Resistance measurement (Ω) → continuity check (\rightarrow) → diode test (\rightarrow) → resistance measurement (Ω)
- μA position: DC current (\rightarrow) → AC current (\sim) → DC current (\rightarrow)
- mA position: DC current (\rightarrow) → AC current (\sim) → DC current (\rightarrow)
- A position: DC current (\rightarrow) → AC current (\sim) → DC current (\rightarrow)

4-3 Data Hold: DATA HOLD

When the **DATA HOLD** button is pressed, the value indicated will be held. (“**DH**” will appear on the display.) The indicated value will not change if the measurement input fluctuates.

When this button is pressed again, the hold status will be canceled and the meter will return to the measurement mode. (“**DH**” will disappear from the display.)

Remarks:

The hold status is also canceled when the function is switched.

4-4 Backlight: BACK LIGHT

When the **SELECT** and **DATA HOLD** buttons are pressed simultaneously, the backlight is turned on (it turns off automatically in about 1 minute).

To turn off the back light, press the **SELECT** and **DATA HOLD** buttons simultaneously again.

Remarks:

Because the **SELECT** and **DATA HOLD** buttons serve as the backlight function select buttons also, when the backlight is turned on or off, the select and data hold functions are also activated. To select the desired select or data hold setting, press the **SELECT** or **DATA HOLD** button individually.

4-5 Range Hold: RANGE HOLD

When the RANGE HOLD button is pressed, the meter is set in the manual mode and the range is fixed. (“AUTO” disappears from the display.) In the manual mode, each time this button is pressed, the range changes. While checking the unit and decimal point on the display, select the best range.

To return to the auto range, hold this button pressed for 1 second or longer. (“AUTO” appears on the display.)

4-6 Relative Measurement: RELATIVE

When the RELATIVE button is pressed, REL and Δ will light and the input value when the button was pressed will be displayed as the reference.

To check the input value that was set as the reference value at the moment the RELATIVE button was pressed, press the button again (for less than a second). REL and Δ flickers and the reference value is displayed. Press the button again (for less than a second) to return to the relative measurement mode.

To cancel the relative measurement mode, hold the button pressed again for 1 second or longer.

Example: Display after the button is pressed at DC 6.000 V input

Actual Input Value	Value In Display
DC 6.000 V	DC 0.000 V
DC 10.00 V	DC 4.000 V
DC 3.000 V	DC -3.000 V

Remarks:

The relative measurement mode is also canceled when the function is switched.

The manual range is engaged in the relative measurement mode.

4-7 Auto Power Off

When the switches and pushbuttons of the multimeter have not been operated for about 30 minutes while the power is on, the multimeter turns off automatically and the display is turned off. If a button is pressed or the function is switched while the power is on, the Auto Power Off is extended for 30 minutes from that moment.

To return from the Auto Power Off mode, press one of the four push buttons.

To cancel the Auto Power Off function, turn the function switch to a position other than OFF while holding the **RANGE HOLD** or **RELATIVE** button pressed.

“APO” on the display is turned off when the Auto Power Off function is canceled.

Remarks:

- The Auto Power Off function is defeated during the PC Link operation.
- When returning from the Auto Power Off mode, the power is turned on while the data is held at the measurement value immediately before the Auto Power Off mode was engaged. To resume the measurement, cancel the data hold status.
- Even in the Auto Power Off mode, the current about 1/100 that of ordinary usage is consumed. When the meter is not going to be used for an extended period of time, be sure to turn off the power switch.

4-8 Battery Low Warning Indication

When the built-in batteries have been discharged and the voltage has dropped to below about 2.3 V, “” mark appears in the display. When this mark flickers or lights, replace both two batteries with new ones.

4-9 AC Detection Method

This meter employs the root-mean-square value method and indicates the magnitude of AC as the same amount of work as DC. Root-mean-square values of sinusoidal waves and such non-sinusoidal waves as square waves and chopping waves can be measured by the true RMS (Root Mean Square) circuit.

4-10 Crest Factor

The CF (crest factor) indicates the peak value of a signal by dividing it by its root-mean-square value. With most common waveforms such as sinusoidal wave and chopping wave, the crest factor is relatively low. With waveforms similar to low duty cycle pulse trains, the crest factor is high. For the voltages and crest factors for typical waveforms, see the table below.

Please measure the crest factor by 3 or less.

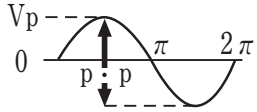
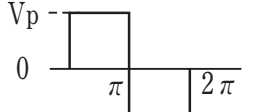
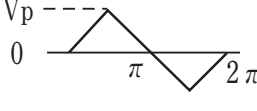
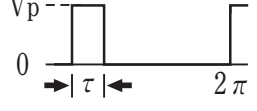
	Input Waveform	0 to PEAK Vp	Root Mean Square Value Vrms	Average Value Vavg	Crest Factor Vp/Vrms	Form Factor Vrms/Vavg
Sinusoidal wave		Vp	$\frac{V_p}{\sqrt{2}}$ =0.707Vp	$\frac{2V_p}{\pi}$ =0.637Vp	$\sqrt{2}$ =1.414	$\frac{\pi}{2\sqrt{2}}$ =1.111
Square wave		Vp	Vp	Vp	1	1
Chopping wave		Vp	$\frac{V_p}{\sqrt{3}}$ =0.577Vp	$\frac{V_p}{2}$ =0.5Vp	$\sqrt{3}$ =1.732	$\frac{2}{\sqrt{3}}$ =1.155
Pulse		Vp	$\sqrt{\frac{\tau}{2\pi}} \cdot V_p$	$\frac{\tau}{2\pi} \cdot V_p$	$\sqrt{\frac{2\pi}{\tau}}$	$\sqrt{\frac{2\pi}{\tau}}$

Voltages of Various Waveforms

- This meter employs AC coupling for AC measurement. The DC components in input signals are cut.

4-11 Connection with PC

The multimeter is capable of DMM data communication using the USB interface.

When the multimeter on which the optional USB optical communication unit (KB-USB773) is mounted is connected to a PC, the multimeter will output data to the PC. It is required to purchase the optional PC link software (PC Link7) for this operation.

For details, refer to the Help for the optional PC link software (PC Link7).

<Connection of cable and multimeter>

- ① Remove the light-shield rubber cap from the rear case of the multimeter.
- ② Connect the USB optical communication unit to the multimeter.

- ③ Connect the USB connector to a PC.
- ④ To disconnect the USB optical communication unit, pull it while holding down the section inscribed with "PUSH" as shown in the figure.

Remarks:

The Auto Power Off function is defeated during the PC Link operation. The Auto Power Off function is also defeated if power enters the communication block of the multimeter. Therefore, when the USB optical communication unit is not connected to the multimeter, be sure to attach the light-shield rubber cap.

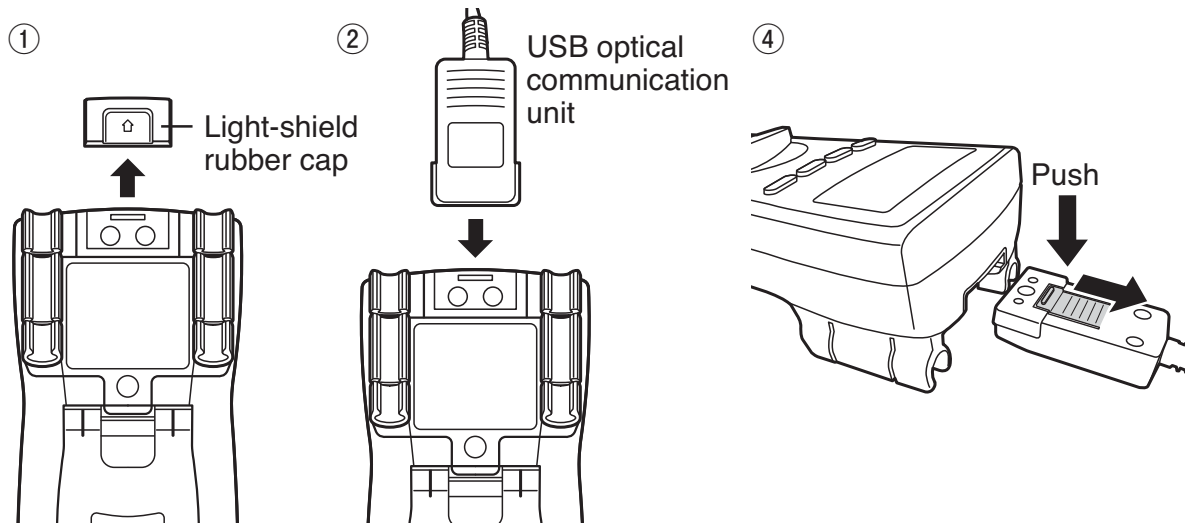

[5] MEASURING PROCEDURE

⚠ WARNING

1. Do not apply an input signal exceeding the maximum rated input of each function.
2. During measurement, do not change the function switch.
3. During measurement, do not touch the test pin side of the flange of the test lead.
4. When measurement is finished, remove the test pins from the object measured and return the function switch to the **OFF** position.

5-1 Start-up Inspection

⚠ CAUTION

1. Be sure that the battery low warning mark is not flickering or lit, when the meter is turned on. If it is flickering or lit, replace the batteries with new ones.
2. Do not use the meter if the meter or test lead is damaged or broken.
3. Make sure the test leads are not cut and the fuse is not blown.

Always conduct the start-up inspection to ensure safety. (Inspection by the continuity check.)

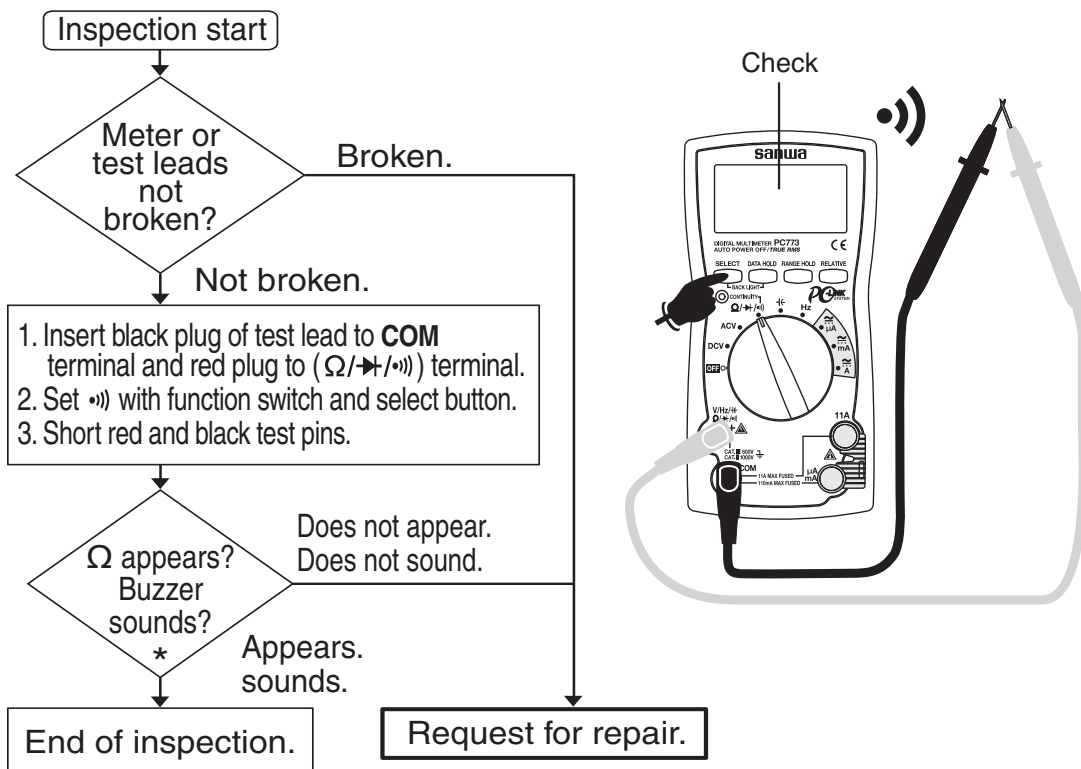

* If nothing appears on the display, the batteries may be discharged completely.

5-2 DC Voltage Measurement (DCV)

Function	Max. Rated Input	Range
DCV	DC 1000 V	110.00 mV, 1.1000 V, 11.000 V, 110.00 V, 1000.0 V

DCV measurement example

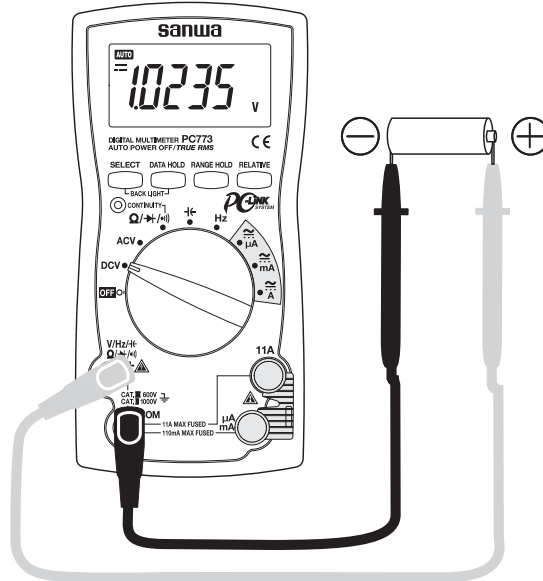

Remarks:

- The DC 110 mV range can be selected with the **RANGE HOLD** button. Since this range is a high-input impedance, display may fluctuate or show “OL” when the test leads are released. It is not a failure.

5-3 AC Voltage Measurement (ACV)

Function	Max. Rated Input	Range
ACV	AC 1000 V	110.00 mV, 1.1000 V, 11.000 V, 110.00 V, 1000.0 V

ACV measurement example

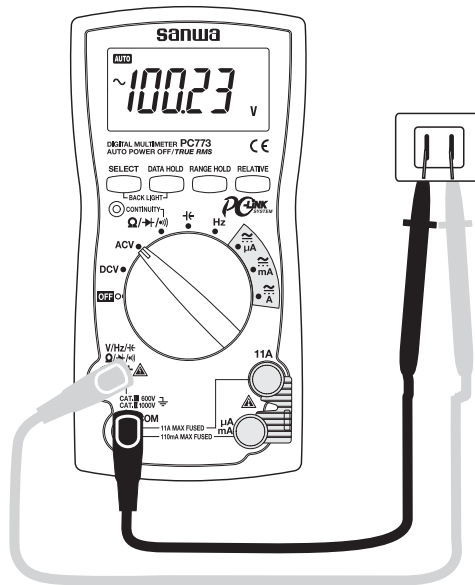

Remarks:

- The AC 110 mV range can be selected with the **RANGE HOLD** button.
- The display may fluctuate or show “OL” when the test leads are released. It is not a failure.
- The AC measurements of this multimeter are of true root-mean-square value response (AC coupling). The accuracy guarantee range is as follows:

AC frequency bandwidth: 110 mV range	45-100 Hz
1.1V range	45-500 Hz
11 V and over	45 Hz-1 kHz

Crest factor (CF) range: 3 max.

Range: 5% to 100% of each range

5-4 Resistance Measurement (Ω), Continuity Check (•))) Diode Test (\rightarrow)

! WARNING

Never apply a voltage to the measuring terminals.

5-4-1 Resistance measurement (Ω)

Function	Max. Rated Input	Range
Ω	110 M Ω	110.00 Ω , 1.1000 k Ω , 11.000 k Ω , 110.00 k Ω , 1.1000 M Ω , 11.000 M Ω , 110.0 M Ω

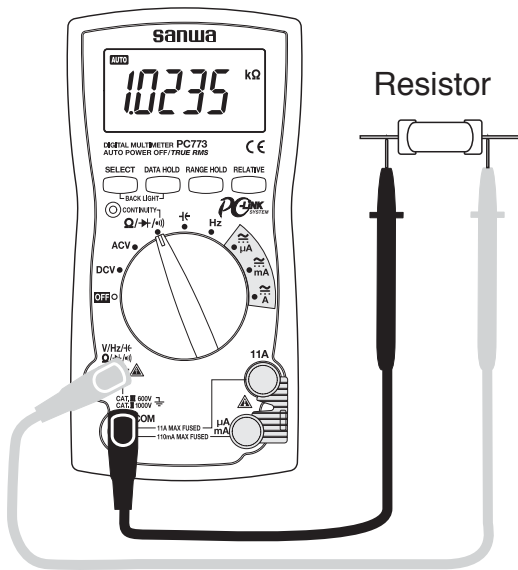

Remarks:

If measurement is affected by noises, shield the object to measure with COM potential. If measurement is conducted with a finger touching the test pins, an error occurs due to influence of resistance of the human body.

When measuring resistance in the 110 Ω range, short the test pins and press the **RELATIVE** button to cancel the currently displayed value before connecting the resistance.

The open voltage between the measuring terminals is as follows.

110 Ω range: Approximately equal to the power supply voltage.

1.1 k Ω range or higher: Approx. 0.33 V.

5-4-2 Continuity check (•)))

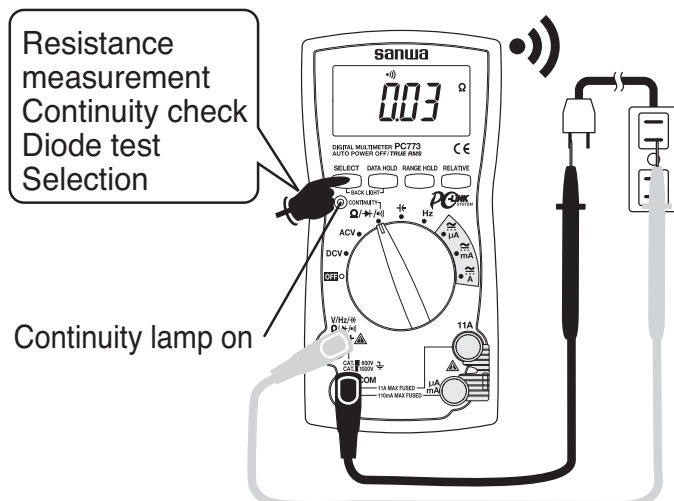

Remarks:

- Continuity buzzer sounds and continuity lamp turns on when the displayed value is less than 30 Ω .

5-4-3 Diode test (→)

Resistance measurement
Continuity check
Diode test Selection

Remarks:

The open voltage between the measuring terminals is equal to: Power supply voltage – Approx. 0.2 V.

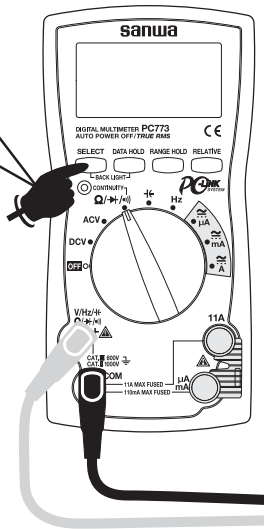

Forward direction test

5562 V

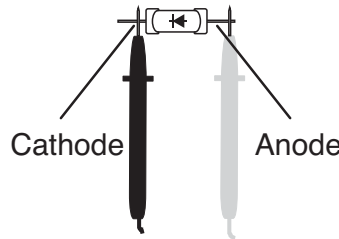

Reverse direction test

OL V



Good: Forward voltage drop shown
Bad: 0.000V shown
OL shown

Good: OL shown
Bad: Other indication

5-5 Capacitance Measurement (⇐)

WARNING

Never apply a voltage to the measuring terminals.

CAUTION

1. Remove electric charge in the capacitor prior to measurement.
2. Because this meter applies a current to the capacitor to measure, it is not suitable for measurement of electrolytic capacitors having a large leak current as a large error may occur.
3. For capacitors having large capacitance, measurement takes a longer time.

Function	Max. Rated Input	Range
CAP (⇐)	110.00 mF	11.000 nF, 110.00 nF, 1.1000 μ F, 11.000 μ F, 110.00 μ F, 1.1000 mF, 11.000 mF, 110.00 mF

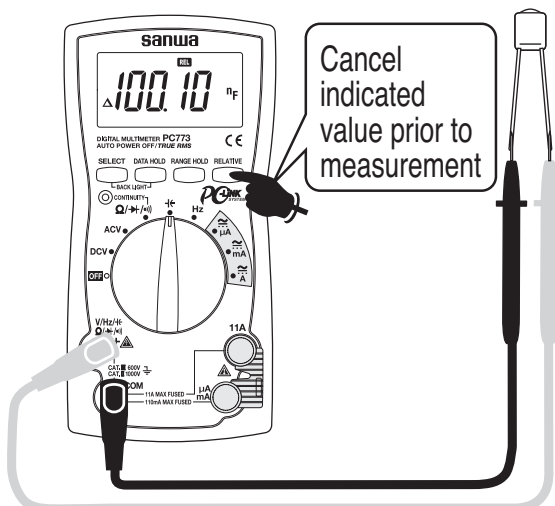

Cancel indicated value prior to measurement

Remarks:

- For capacitance measurement in the 11 nF and 110 nF ranges, press the **RELATIVE** button to cancel the indicated value before connecting the capacitor to be measured and then perform the measurement.
- The indication may not become stable due to influence of surrounding noises or stray capacitance of the test leads.

5-6 Frequency Measurement (Hz)

⚠ CAUTION

Never use the meter for measuring frequencies to ground as the earth leakage breaker may trip.

Measurement prohibited

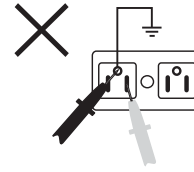

Function	Max. Rated Input	Range
Hz	1.1 MHz (≤ 1000 Vrms)	110.0 Hz, 1100 Hz, 11.000 kHz, 110.00 kHz, 1.1000 MHz

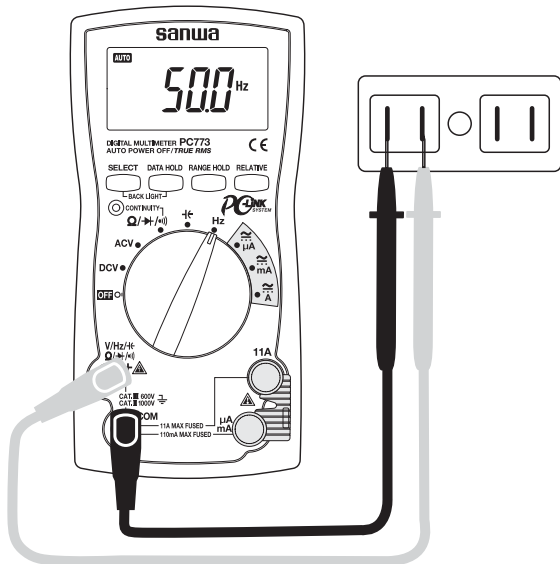

- Because the Hz function uses input resistance as low as approx. 1 k Ω , a large amount of current flows during measurement. Never use the meter for measuring circuits or devices having a small current capacity.
- The measuring value is not stable in case if measured frequency contains some noises.

Remarks:

- Input sensitivity: 5 Vrms or over
- Zero cross (+ potential \rightarrow - potential \rightarrow + potential) frequencies can be measured. Frequencies of + potential only or - potential only such as logic pulses cannot be measured.
- Frequencies less than 11.1 Hz cannot be measured.

5-7 Current Measurement (μA / mA / A)

⚠ WARNING

1. Never apply a voltage to the measuring terminals.
2. Never apply an input exceeding the maximum rated current.
3. Be sure to connect the meter in series via a load.

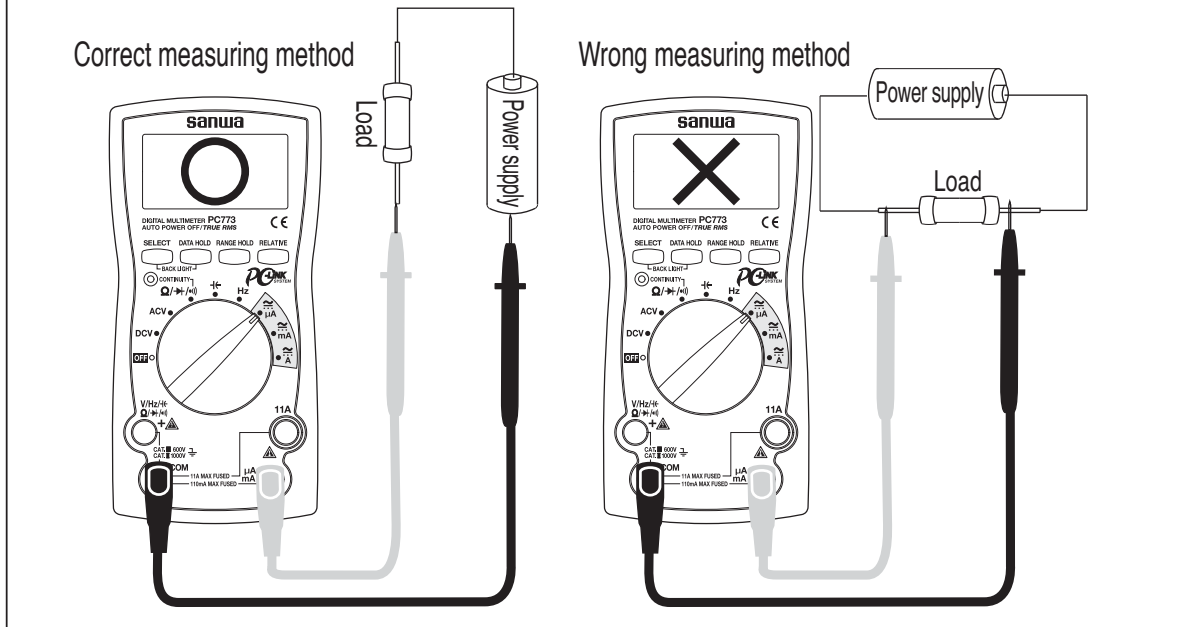

⚠ CAUTION

Be sure that the built-in fuse has not blown.

Function	Max. Rated Input	Range
DC/AC μA	110 μA	110.00 μA , 1100.0 μA
DC/AC mA	110 mA	11.000 mA , 110.00 mA
DC/AC A	11 A	11.000 A

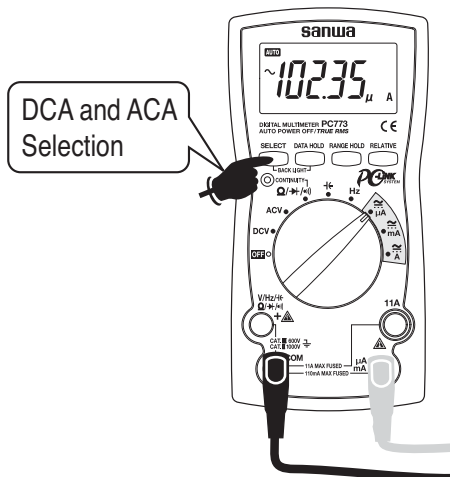

Remarks:

- In current measurement, the internal resistance of the current range is placed in series and the current drops by this resistance. Accordingly, its influence becomes larger in low-resistance circuits.
- The AC accuracy guarantee frequency range is from 45 Hz to 1kHz.

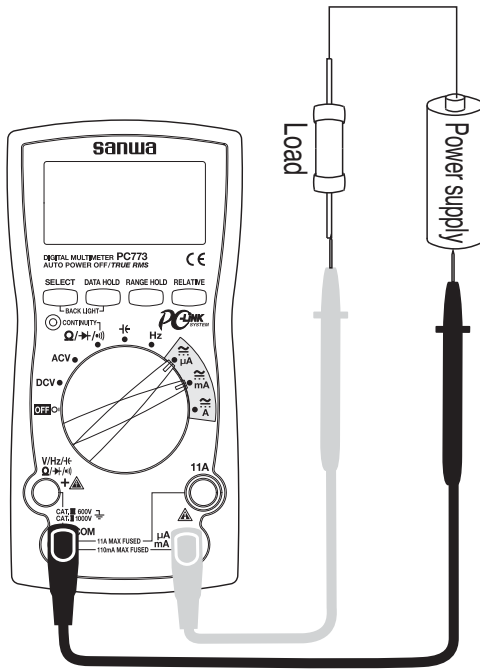

µA · mA measurement

Function	Input Terminal	Built-in Fuse
µA	µA and COM	315mA/1000V Fuse Breaking capacity 30kA
mA		

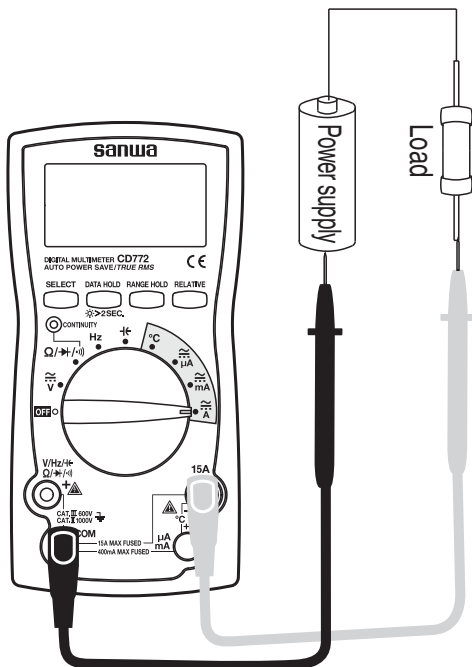

A measurement

Function	Input Terminal	Built-in Fuse
A	15A and COM	12A/1000V Fuse Breaking capacity 30kA

Remarks:

If the indication changes little when an input signal is applied or a current value which is significantly smaller than the expected value is indicated, possible causes are the input terminals, incorrect setting of the function switch, or blown fuse. Check these points.

5-8 Measurements Using Optional Products

WARNING

1. Never apply an input signal exceeding the maximum rated input value of the optional product.
2. Do not switch the function while measuring.

5-8-1 Measurement Using a DC High-Voltage Probe (HV-60) Max. measuring voltage: 30 kV DC

WARNING

1. This probe is for exclusive use in measurement of a very small-current circuit. Do not use it for measurement of large current of a power line, etc.
2. Never apply a voltage exceeding the maximum measuring voltage of the probe (30 kV DC).
3. Do not switch the function in the middle of measurement.
4. Do not hold the probe by the section between the guard and measuring pin during measurement.

- 1) Applications: Voltage of a high-impedance circuit, such as the anode voltage of CRT or a high voltage used for focusing.
- 2) Measuring range: DC 1000 V range (to be set in the manual mode).
- 3) Measuring procedure:
 - ① Connect the red plug of the high-voltage probe to the V input terminal and the black plug to the COM input terminal.
 - ② Set the function switch to “DCV” and press the RANGE HOLD button to select the 1000 V range.
 - ③ Connect the black clip to the grounding line of the measuring target and apply the test pin at the distal end of the probe to the measuring point.
 - ④ Multiply the display reading by 0.1. This is the measurement value in the unit of kV.
 - ⑤ After measurement, withdraw the test pin from the measuring circuit and then remove the clips.
- The HV-60 cannot be used to measure AC voltages.

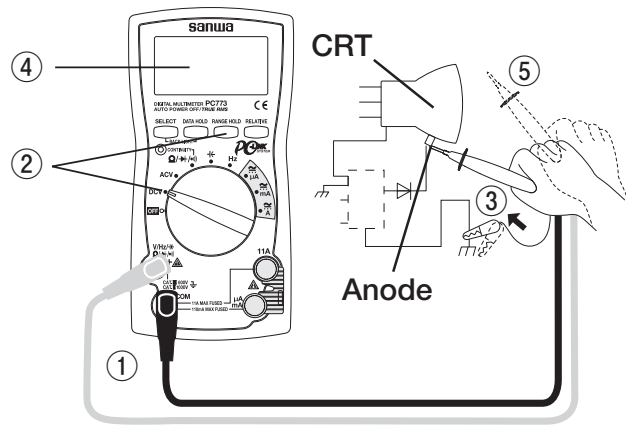

5-8-2 Measurement Using an AC Clamp Probe (CL-20D) Max. measuring current: 200 A AC

- 1) Applications: Sine-wave current of 50 to 60 Hz AC, such as the current consumption of a home appliance or a power supply.
- 2) Measuring ranges: Two ranges including 20 A and 200 A.
- 3) Measuring procedure:
 - ① Connect the red plug of the clamp probe to the V input terminal and the black plug to the COM input terminal.
 - ② Set the function switch to “ACV” and press the RANGE HOLD button to select the 11 V range.
 - ③ Set the range switch of the clamp probe to the 20 A or 200 A range.
 - ④ Open the clamp jaws of the clamp probe and clamp the measuring target wire with it.
 - ⑤ Multiply the reading by 10 when the 20 A range is selected on the clamp probe or by 100 when the 200 A range is selected.
 - ⑥ After measurement, open the clamp jaws of the clamp probe to release it from the measuring target wire.
- It is not possible to measure a current over 20 A or 200 A. (A reading is displayed but it is not accurate.)
- Clamp the measuring wire at the position as close to the center of the clamp jaws as possible.

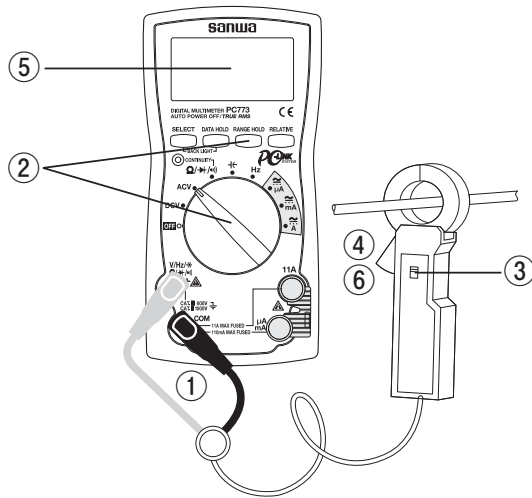

5-8-3 Measurement Using an AC/DC Clamp Probe (CL-22AD) Max. measuring current: 200 A AC/DC

1) Applications:

ACA: Sine-wave current of 50 to 60 Hz AC, such as the current consumption of a home appliance or a power supply.

DCA: Current of the electric circuit of an automobile or the current consumption of a DC device.

2) Measuring ranges: Two ranges including 20/200 A DC and 20/200 A AC.

3) Measuring procedure:

① Connect the red plug of the clamp probe to the V input terminal and the black plug to the COM input terminal.

② To measure a DC current (DCA), set the function switch to “DCV” and press the RANGE HOLD button to select the 1.1 V range.

To measure an AC current (ACA), set the function switch to “ACV” and press the RANGE HOLD button to select the 1.1 V range.

③ Set the range knob of the clamp probe to the 20 A or 200 A range.

* When measuring a DC current, perform the 0 (zero) adjustment of the clamp probe by turning its zero adjustment knob.

- ④ Open the clamp jaws of the clamp probe and clamp the measuring wire.
- ⑤ In the 20 A range of the clamp probe, multiply the display reading by 100, and in the 200 A range, multiply the display reading in 1000.
- ⑥ After measurement, open the clamp jaws of the clamp probe to release it from the measuring wire.
- It is not possible to measure a current over 20 A or 200 A. (A reading is displayed but it is not accurate.)

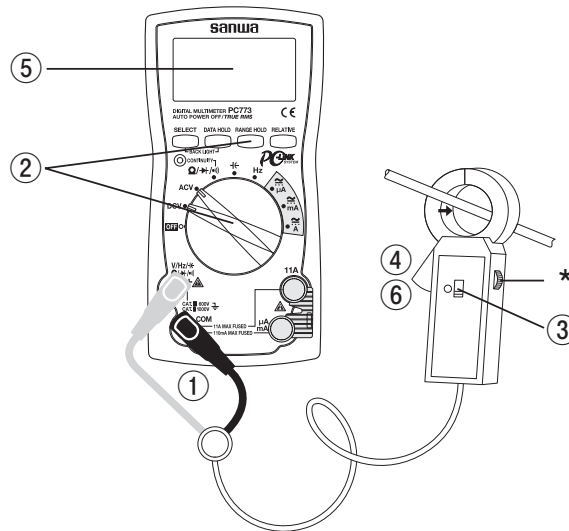

5-8-4 Measurement Using a DC Clamp Probe (CL-33DC) Max. measuring current: 300 A DC

- 1) Applications: Current of the electric circuit of an automobile or the current consumption of a DC device.
- 2) Measuring ranges: Two ranges including 30A and 300 A.
- 3) Measuring procedure:
 - ① Connect the red plug of the clamp probe to the V input terminal and the black plug to the COM input terminal.
 - ② Set the function switch to “DCV” and press the RANGE HOLD button to select the 1.1 V range.

- ③ Set the range switch of the clamp probe to the 30 A or 300 A range.
 - * Perform the 0 (zero) adjustment of the clamp probe by turning its zero adjustment knob.
- ④ Open the clamp jaws of the clamp probe and clamp the measuring wire.
- ⑤ Multiply the reading by 100 when the 30 A range is selected on the clamp probe or by 1000 when the 300 A range is selected.
- ⑥ After measurement, open the clamp jaws of the clamp probe to release it from the measuring target wire.
- It is not possible to measure a current over 30 A or 300 A. (A reading is displayed but it is not accurate.)

5-8-5 Measurement Using the Temperature Probe (T-300PC)

1) Applications

To measure temperature.

- * Measurement cannot be performed by this probe alone. Connect it to the meter first. Then connect the meter to a PC that the Sanwa PC Link7 software is installed.

2) Measuring ranges

Range of -50 °C to 300 °C

- * Use 11 k Ω range.

3) Measurement procedure

- ① Connect the black plug to COM measuring terminal and the red plug to Ω measuring terminal.
- ② Set the function to Ω (→/•) and select Ω by pressing the **SELECT** button.
- ③ Press the **RANGE HOLD** button to hold the 11k Ω range.
- ④ Apply the sensor to an object to be measured.
- ⑤ Read the value in the measurement value window of the software.
- ⑥ After measurement, release the sensor from the object measured.

[6] MAINTENANCE

WARNING

1. The following instructions are very important for safety.
Read this manual thoroughly to ensure correct maintenance.
2. Calibrate and inspect the meter at least once a year to ensure safety and maintain its accuracy.

6-1 Maintenance and Inspection

- 1) Appearance: Is the meter not damaged due to falling or other cause?
- 2) Test leads:
 - Are the core wires not exposed from the test leads?
 - Is the plug when inserted to the input terminal not loose?If any of the above problems exists, stop using the meter and request for repair.

6-2 Calibration and Inspection

For more information, please contact Sanwa's authorized agent / distribute service provider, listed in our website.
See section 7-3.

6-3 Storage

CAUTION

1. The panel and case are not resistant to volatile solvent and must not be cleaned with thinner or alcohol.
2. The panel and case are not resistant to heat. Do not place the meter near heat-generating devices.
3. Do not store the meter in a place where it may be subjected to vibration or where it may fall.
4. Do not store the meter in places under direct sunlight, or hot, cold or humid places or places where condensation is anticipated.
5. If the meter will not be used for a long time, remove the batteries.

6-4 Battery and Fuse Replacement

Batteries when the meter is shipped:

A battery for monitoring has been installed prior to shipment from the factory. It may be discharged before the expiration of the described battery life.

*The battery for monitoring is a battery used to check the functions and performance of the product.

⚠ WARNING

1. To avoid electric shock, do not remove the rear case with an input being applied to the measuring terminals. Also, before starting replacement, make sure the power of the meter is OFF.
2. Be sure to use the replacement fuse of the same rating. Never use a substitute for the fuse nor short the meter.

6-4-1 Battery replacement

- ① Remove the fixing screw of the battery holder with a screwdriver.
- ② Replace both two batteries in the battery holder with new ones.
(Pay attention to their polarity.)
- ③ Set and secure the battery holder with the fixing screw as before.

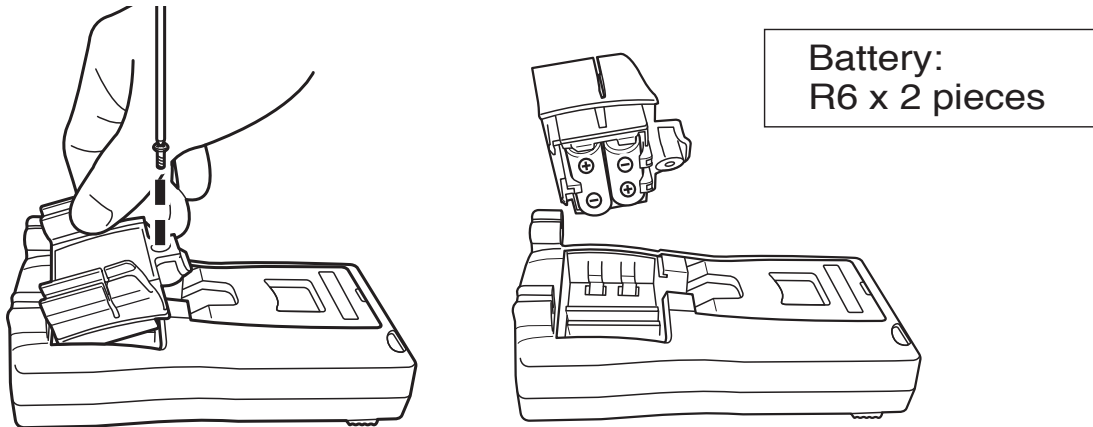

6-4-2 Fuse replacement

- ① Remove the screws of the body rear case with a screwdriver.
- ② Take out the fuse and replace it with a new one.
- ③ Secure the rear case with the screws as before.

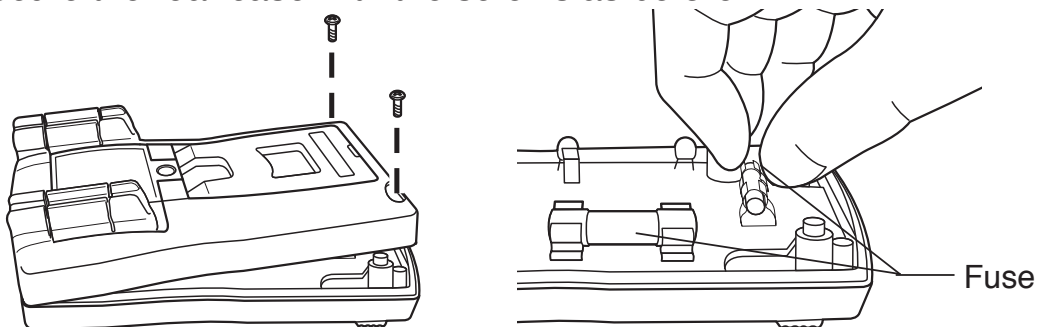

Fuse rating:

315mA/1000V (ø6.35 x 32 mm, Breaking capacity 30kA)

12A/1000V (ø10 x 38 mm, Breaking capacity 30kA)

* Spare fuse storage is provided at the bottom of the rear case. (For ø6.35 x 32 mm fuse only)

[7] AFTER-SALE SERVICE

7-1 Warranty and Provision

Sanwa offers comprehensive warranty services to its end-users and to its product resellers. Under Sanwa's general warranty policy, each instrument is warranted to be free from defects in workmanship or material under normal use for the period of one (1) year from the date of purchase.

This warranty policy is valid within the country of purchase only, and applied only to the product purchased from Sanwa authorized agent or distributor.

Sanwa reserves the right to inspect all warranty claims to determine the extent to which the warranty policy shall apply. This warranty shall not apply to disposables batteries, or any product or parts, which have been subject to one of the following causes:

1. A failure due to improper handling or use that deviates from the instruction manual.
2. A failure due to inadequate repair or modification by people other than Sanwa service personnel.
3. A failure due to causes not attributable to this product such as fire, flood and other natural disaster.
4. Non-operation due to a discharged battery.
5. A failure or damage due to transportation, relocation or dropping after the purchase.

7-2 Repair

Customers are asked to provide the following information when requesting services:

1. Customer name, address, and contact information
2. Description of problem
3. Description of product configuration
4. Model Number
5. Product Serial Number
6. Proof of Date-of-Purchase
7. Where you purchased the product

Please contact Sanwa authorized agent / distributor / service provider, listed in our website, in your country with above information. An instrument sent to Sanwa / agent / distributor without above information will be returned to the customer.

Note:

- 1) Prior to requesting repair, please check the following:
Capacity of the built-in battery, polarity of installation and discontinuity of the test leads.
- 2) Repair during the warranty period:
The failed meter will be repaired in accordance with the conditions stipulated in 7-1 Warranty and Provision.
- 3) Repair after the warranty period has expired:
In some cases, repair and transportation cost may become higher than the price of the product. Please contact Sanwa authorized agent / service provider in advance.
The minimum retention period of service functional parts is 6 years after the discontinuation of manufacture. This retention period is the repair warranty period. Please note, however, if such functional parts become unavailable for reasons of discontinuation of manufacture, etc., the retention period may become shorter accordingly.
- 4) Precautions when sending the product to be repaired
To ensure the safety of the product during transportation, place the product in a box that is larger than the product 5 times or more in volume and fill cushion materials fully and then clearly mark "Repair Product Enclosed" on the box surface. The cost of sending and returning the product shall be borne by the customer.

7-3 SANWA web site

<http://www.sanwa-meter.co.jp>

E-mail: exp_sales@sanwa-meter.co.jp

[8] SPECIFICATIONS

8-1 General Specifications

Operation method	Double integration
AC measuring method	True RMS value method
LCD	11000 count
Sampling rate	Approx. 4 times/sec. (DCV / ACV / Ω / μ A / mA / A) Approx. 20 times/sec. (•) / \rightarrow Approx. 4 times/sec. (\leftarrow : 11 μ F or lower range) Approx. 2 times/sec. (\leftarrow : 110 μ F range) Approx. 1 time/sec. (\leftarrow : 1.1 mF range) Approx. 0.4 time/sec. = 2.5 sec./time (\leftarrow : 11 mF range) Approx. 0.08 time/sec. = 12.5 sec./time (\leftarrow : 110 mF range)
Range selection	Auto and manual
Over-range indication	“OL” shown on display (DCV, ACV and 11 A excluded.)
Polarity switching	Auto (Only “-“ is displayed.)
Battery low warning	“  ” lights or flickers when the internal battery voltage is exhausted at approx. 2.3 V or below.
Environmental condition	Altitude 2000 meters or below, pollution degree II
Operating temperature/humidity	5°C to 40°C in the humidity range as follows. No condensation allowed. 80%RH (max.) at 5°C to 31°C, Linearly dropping from 80%RH to 50%RH at 31°C to 40°C.
Storage temperature/humidity	-10°C to +40°C, 80%RH max., no condensation. 40°C to 50°C, 70%RH max., no condensation. (When the multimeter will not be used for a long time, remove the batteries before storage.)
Power supply	SUM-3 (R6) batteries, 2 pieces
Power consumption	Approx. 7.5 mW typ. (DCV)
Battery life	Approx. 200 hours
Auto Power Off	Power OFF in about 30 minutes after last operation. (The Auto Power Off function is defeated during the PC Link operation.)
Fuses	315 mA/1000 V, breaking capacity 30 kA. 12 A/1000 V, breaking capacity 30 kA
Safety standards	IEC61010-1 CAT. III 600 V, CAT. II 1000 V IEC61010-031

EMC Directive	IEC61326
Dimensions	166(L) x 82(W) x 44(D) mm, projections not included.
Weight	Approx. 360 grams (batteries included)
Standard accessories included	Test leads (TL-25), Instruction Manual
Optional products	USB optical communication unit: KB-USB773 PC Link software: PC Link7 Alligator clips: CL-11, CL-15, TL-81C High-voltage probe: HV-60 Clamp probes: CL-22AD, CL-33DC, CL-20D Carrying case: C-77, C-77H

8-2 Measuring Range and Accuracy

Temperature: $23 \pm 5^{\circ}\text{C}$, humidity: 80%RH max. (no condensation), supply voltage 2.4 V or above.

rdg (reading): Read value. dgt (digit): Number of counts of last digit.

DC voltage

Range	Accuracy	Input Resistance	Remarks
110.00 mV	$\pm(0.38\% \text{ rdg} + 2 \text{ dgt})$	\geq Approx. 100 M Ω	
1.1000 V	$\pm(0.28\% \text{ rdg} + 2 \text{ dgt})$	Approx. 11 M Ω	
11.000 V	$\pm(0.38\% \text{ rdg} + 2 \text{ dgt})$	Approx. 10 M Ω	
110.00 V			
1000.0 V			

AC voltage

Range	Accuracy	Input Resistance	Remarks
110.00 mV	$\pm(0.9\% \text{ rdg} + 50 \text{ dgt})$	\geq Approx. 100 M Ω	<ul style="list-style-type: none"> Accuracy guaranteed frequency ranges: 110 mV range 45 Hz - 100 Hz 1.1 V range 45 Hz – 500 Hz 11 V and over 45 Hz - 1 kHz Crest factor (CF) range: 3 max. Range: 5% to 100% of each range.
1.1000 V	$\pm(0.7\% \text{ rdg} + 50 \text{ dgt})$	Approx. 11 M Ω	
11.000 V	$\pm(0.9\% \text{ rdg} + 50 \text{ dgt})$	Approx. 10 M Ω	
110.00 V			
1000.0 V			

Ω Resistance

Range	Accuracy	Remarks
110.00 Ω	±(0.4% rdg + 6 dgt)	<ul style="list-style-type: none"> • Open circuit voltages: 110 Ω range about power supply voltage 1.1 kΩ and over approx. 0.33 V • The measuring current varies depending on the value of resistance to measure. • When measuring resistance in the 110 Ω range, short the test pins and press the RELATIVE button to cancel the currently displayed value before connecting the resistance.
1.1000 kΩ	±(0.3% rdg + 6 dgt)	
11.000 kΩ		
110.00 kΩ	±(0.6% rdg + 6 dgt)	
1.1000 MΩ	±(0.8% rdg + 6 dgt)	
11.000 MΩ	±(2.0% rdg + 6 dgt)	
110.0 MΩ	±(5.0% rdg + 6 dgt)	

•)) Continuity check

Buzzer sound and continuity lamp ON range: Less than 30 Ω.

➔ Diode test

Open circuit voltage: Power supply voltage – Approx. 0.2 V.

⇐ Capacitance

Range	Accuracy	Remarks
11.000 nF	±(4.0% rdg + 30 dgt)	<ul style="list-style-type: none"> • Accuracies in the 11 nF and 110 nF ranges are the values obtained after canceling the indicated values by the Relative function. • When measuring electrostatic capacity of capacitor with little leakage current such as film capacitor.
110.00 nF	±(2.0% rdg + 20 dgt)	
1.1000 μF		
11.000 μF	±(3.0% rdg + 10 dgt)	
110.00 μF		
1.1000 mF	±(10% rdg + 10 dgt)	
11.000 mF		
110.00 mF	±(20% rdg + 10 dgt)	

Hz Frequency

Range	Accuracy	Remarks
110.0 Hz	$\pm(0.01\% \text{ rdg} + 2 \text{ dgt})$	<ul style="list-style-type: none"> • Sensitivity: 5 Vrms or over. • Frequency less than 11.1 Hz cannot be measured. • Input resistance \geq Approx. 1 kΩ. • Because the input resistance is as low as approx. 1 kΩ, a large amount of current will flow during measurement. Never use the multimeter for measuring circuits or devices having a small current capacity. Never use the multimeter for measuring frequencies to ground as the earth leakage breaker may trip.
1100 Hz		
11.000 kHz		
110.00 kHz		
1.1000 MHz		

DC current

Range	Accuracy	Input Resistance	Remarks
110.00 μA	$\pm(0.5\% \text{ rdg} + 4 \text{ dgt})$	Approx. 1 k Ω	<ul style="list-style-type: none"> • The input resistance excludes the fuse resistance.
1100.0 μA			
11.000 mA	$\pm(0.7\% \text{ rdg} + 4 \text{ dgt})$	Approx. 10 Ω	
110.00 mA			
11.000 A	$\pm(0.5\% \text{ rdg} + 8 \text{ dgt})$	Approx. 0.01 Ω	

~ AC current

Range	Accuracy	Input Resistance	Remarks
110.00 μ A	$\pm(0.9\% \text{ rdg} + 20 \text{ dgt})$	Approx. 1 k Ω	<ul style="list-style-type: none"> • Accuracy guaranteed frequency ranges: 45 Hz - 1 kHz. Crest factor (CF) range: 3 max. Range: 5% to 100% of each range • The input resistance excludes the fuse resistance.
1100.0 μ A			
11.000 mA	$\pm(1.1\% \text{ rdg} + 20 \text{ dgt})$	Approx. 10 Ω	
110.00 mA			
11.000 A	$\pm(0.9\% \text{ rdg} + 40 \text{ dgt})$	Approx. 0.01 Ω	

- * Accurate measurement may not be possible in places where a strong magnetic field is present, for example near a transformer or large-current line, or in places where a strong electric field is present, for example near radio equipment.

Accuracy calculation method

Example: DC voltage measurement (DCV).

True value: 100 mV

Range accuracy: 110 mV range ... $\pm(0.38\% \text{ rdg} + 2 \text{ dgt})$

Error: $\pm(100.0 \text{ mV} \times 0.38\% + 2 \text{ dgt}) = \pm 0.40 \text{ mV}$

Indicated value: 100.0 mV $\pm 0.40 \text{ mV}$ (in the range from 99.60 mV to 100.40 mV)

The product specifications described in this manual and its appearance are subject to change without notice for improvement or other reasons.

MEMO

sanwa®

三和電気計器株式会社

本社=東京都千代田区外神田2-4-4・電波ビル

郵便番号=101-0021・電話=東京(03)3253-4871(代)

大阪営業所=大阪市浪速区恵美須西2-7-2

郵便番号=556-0003・電話=大阪(06)6631-7361(代)

SANWA ELECTRIC INSTRUMENT CO.,LTD.

Dempa Bldg., 4-4 Sotokanda2-Chome Chiyoda-Ku, Tokyo, Japan