

Instrumento Multifuncional de Potencia (LCD)

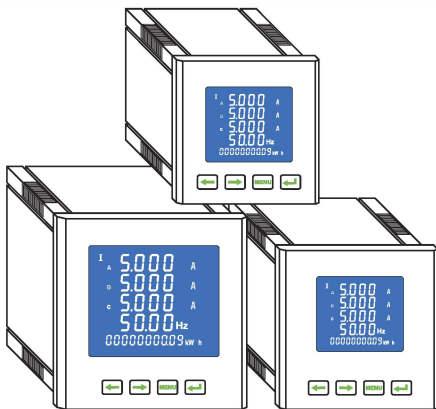

Operational Instruction Manual

ÍNDICE

Capítulo 1. Introducción General	1
Capítulo 2. Funciones del Producto.	2
Capítulo 3. Parámetros Técnicos.	2
Capítulo 4. Programación y uso	4
Capítulo 5. Instalación y cableado.	13
Capítulo 6. Protocolo de comunicación	15
Capítulo 7. El Pulso De Energía Eléctrica.	21
Capítulo 8. Switch value module.	22
Chapter 9. Analog transmitting output module	25
Chapter 10. FAQ and Solutions.	27

Instrumento de Potencia Multifuncional(LCD)

Capítulo 1. Introducción General

Los instrumentos de medición multifuncional (instrument for short below) is specifically designed and made for the electrical monitoring requirement of power distribution system. It is with high-precision measurement all of the common electrical parameters including of three-phase voltage, three-phase current, active power, reactive power, frequency, power factor and four-quadrant energy etc; Long-life LCD display the instrument measuring parameters and operation information of network system; RS485 communication interface, applying MODBUS_RTU communication protocol; with four programmable keys on the instrument panel, convenient switch, programmable setting of instrument parameters with great flexibility.

Many kinds of extended function modules for choosing: four-channel analog quantity (0~20mA/4~20mA) output can realize the transmitting output function of electrical quantity; four-channel switching value input and four-channel switching value output to realize the local or long-range switch signal monitoring and control output function (function of "remote signaling" and "remote control"). The instrument can directly replace conventional power transmitter, measuring indicating instrument, electric energy measuring instrument and the related auxiliary unit. With modular structural design, users can choose the most economical functional configuration according to the actual requirement, which is highly cost-effective.

It is widely used in occasions of energy management systems, supply and distribution network automation, district power control and complete sets of switchgear. It has the advantages of convenient installment and maintenance, sample wiring, small quantity, programmable input parameters and capable of the network with different PLC, industry control computer communications software.

Capítulo 2. Funciones del producto

Funciones ordinarias	Funciones extendidas
<ul style="list-style-type: none"> ● Voltaje por fase : UA, UB, UC ● Voltaje de línea: UAB, UBC, UCA ● Corriente : IA, IB, IC ● Potencia activa: PA,PB,PC,PS ● Potencia reactiva: QA,QB,QC,QS ● Potencia aparente : SA,SB,SC,SS ● Factor de potencia: PFA,PFB,PFC,PFS ● Frecuencia ● Energía Activa ● Energía Reactiva ● 2 channels electric pluse output ● Salida de comunicación : RS485 	<ul style="list-style-type: none"> ● 4 channels analog quantity output ● 4 channels switch value output ● 4 channels switch value input ● Análisis de calidad de potencia Distorsión armónica de Voltaje:THDU Distorsión armónica de corriente:THDI Desbalance de voltaje trifásico:εU Desbalance de corriente trifásico:εI

Capítulo 3. Parámetros técnicos

Parámetros técnicos		Índice	
Entrada	Net work		Tres fases tres-hilos, tres-fases cuatro- hilos
	Voltaje	Rango de valores	0~500V AC
		Sobre carga	Consistente:1.2 veces Instantáneo:2 veces /30s
		Consumo	<0.5VA(cada fase)
		Impedancia	>500kΩ
	Corriente	Rated value	AC 1A, 5A
		Over load	Consistente:1.2 veces Instantáneo:2 veces /1s
		Impedance	<2mΩ
Frequency		45~65Hz	
Salida	Energía eléctrica	Modo de salida	Two-channel open-collector optical coupling pulse output
		Constante de pulso	Active 3200imp/kwh Reactive 3200imp/kvarh
		Inicio	On the condition of rated voltage, reference frequency and $\cos\varphi=1.0$, when load operational current is 0.001In, it can start and measure the electric energy continuously.
		Creep	When exerting 115% rated voltage and no current in the current circuitry, the instrument is with no electric energy accumulation and pulse output.



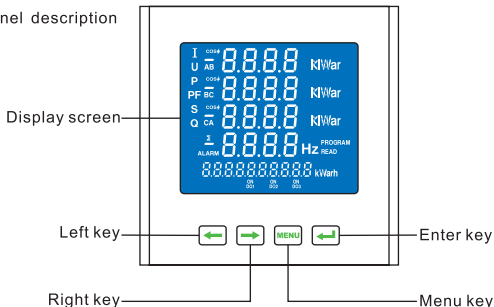

Output	Communication	Output mode	RS485
		Protocol	MODBUS_RTU
		Baud rate	1200,2400,4800, 9600
	Analog quantity	Channel quantity	4 channels
		Output mode	0~20mA, 4~20mA
		Load ability	≤400W
	Switching value	Channel quantity	4 channels
		Output mode	Normally open relay contact output
		Contact capability	AC 240V/2A
	Switching value input		Four channel dry contact input modes
Display mode		LCD(Blue back lighting)	
Measuring accuracy	Voltage, current		±(0.5%FS+one digit)
	Active power, reactive power		±(0.5%FS+one digit)
	Frequency		±0.1Hz
	Harmonic		21 times harmonic content of voltage or current.
	Power factor		±0.01PF
	Active energy		±0.5%(only for reference, not for meterage)
	Reactive energy		±1.0%(only for reference, not for meterage)
Source	Scope		AC 220V,50/60Hz
	Consumption		<5VA
Safety	Withstand voltage	Input and source	>2kv50Hz/1min
		Input and output	>1kv50Hz/1min
		Output and source	>2kv50Hz/1min
Insulating resistance		Any two of input, output, source, casing>20MΩ	
Environment	Temperature		Operation: -10~50°C
			Storage: -25~70°C
	Humidity		≤85%RH, free of wet and corrosive gas
Elevation		≤3000m	

Chapter 4. Program and usage

3.1 Panel description



4.2 Description of key function





-  **Left key:** Under the programming mode, it is used for progressive decrease of parameter value or enter the previous menu. Under the measuring display mode, it is used to enter the previous display mode.
-  **Right key:** Under the programming mode, it is used for degressive increase of parameter value or enter the next menu. Under the measuring display mode, it is used to enter the next display mode.
-  **Menu key:** under the measuring display status, press this key to enter the program mode. After input the correct password (factory password: 0001) "Code" prompted by the instrument, it is capable of programming and setting. Under the programming mode, it is used to return to previous menu with storing parameters.
-  **Enter key:** Under the programming mode, it is used to return to the previous menu when choosing the menu items. The instrument will display "SAVE-YES" when it returns to the measuring display mode from the programming mode, then press the Enter key to save and quit.





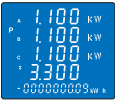

4.3 Description of display mode

Through programming on the "diSP" parameters of the menu, it can choose one of the display mode and also can manually switch the display modes by "Right key" and "Left key". "diSP" value display mode: 1. three-phase current, frequency,

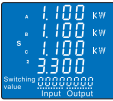
positive active energy;2.three-phase voltage,frequency,positive reactive energy; 3.three-phase active power,total active power,opposite active energy;4.three-phase power factor,total power factor,opposite reactive energy;5.three-phase apparent power,total apparent power,switch value input and output;6.three-phase reactive power,total reactive power,positive active energy;7:voltage total harmonic content;8:current total harmonic content;9:voltage unbalance;10:current unbalance. Under the display mode,switch the display object among the different parameters by press the Left key or Right key.

It will auto display the parameters when the "diSP" value was "0".

Display mode Parameter value	Demonstration	Description
diSP=1		Fixed display three-phase current The left picture shows: A-phase current is 5.200A B-phase current is 5.197A C-phase current is 5.198A Frequency is 50.00Hz Positive active energy is 0.09KWh
diSP=2		Fixed display three-phase voltage The left picture shows: A-phase voltage is 220.1V B-phase voltage is 220.0V C-phase voltage is 220.3V Frequency is 50.00Hz Positive reactive energy is 0.02Kvarh
diSP=3		Fixed display three-phase active power The left picture shows: A-phase active power is 1.100KW B-phase active power is 1.100KW C-phase active power is 1.100KW Total active power is 3.300KW Opposite active energy is 0.09Kvarh
diSP=4		Fixed display three-phase power factor The left picture shows: A-phase power factor is 1.000 B-phase power factor is 1.000 C-phase power factor is 1.000 Total power factor is 1.000 Opposite reactive energy is 0.02Kvarh

diSP=5		<p>Fixed display three-phase apparent power The left picture shows: A-phase apparent power is 1.100KW B-phase apparent power is 1.100KW C-phase apparent power is 1.100KW Total apparent power is 3.300KW</p>
diSP=6		<p>Fixed display three-phase reactive power The left picture shows: A-phase reactive power is 0.000Kvarh B-phase reactive power is 0.000Kvarh C-phase reactive power is 0.000Kvarh Total reactive power is 0.000Kvarh Opposite active energy is 0.09KWh</p>
diSP=7		<p>The three-phase voltage harmonic distortion rate THDU value(data unit:%) as the total harmonic content. A-phase:5.28% A-phase:4.22% A-phase:3.60% Opposite active energy is 0.09KWh</p>
diSP=8		<p>The three-phase current harmonic distortion rate THDI value(data unit:%) as the total harmonic content. A-phase:9.88% A-phase:0.65% A-phase:0.33% Opposite active energy is 0.09KWh</p>
diSP=9		<p>Three-phase voltage unbalance value (data unit:%) voltage unbalance ϵU value:0.02% Opposite active energy is 0.09KWh</p>
diSP=10		<p>Three-phase current unbalance value (data unit:%) current unbalance ϵI value:0.04% Opposite active energy is 0.09KWh</p>

4.4 Menu framework

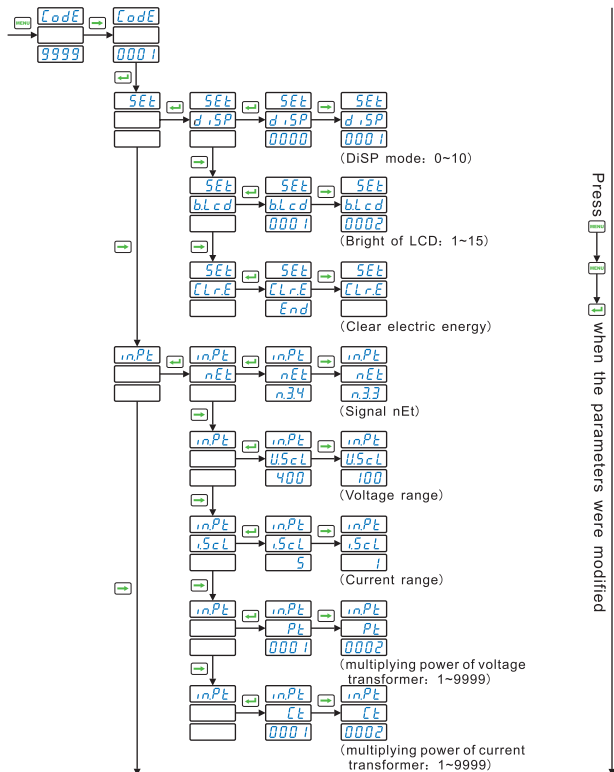

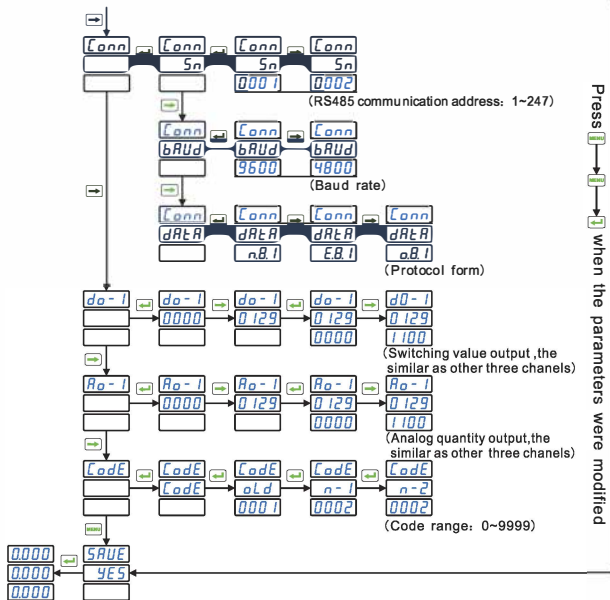

Note:Quit the programming mode, when the instrument displays"save yes", press to save and quit the programming mode.It can not be saved if press button

4.5 Menu significations

Under the programmable mode, four menu setting items including of setting (SEt), input(inPt), communication(Conn), switching value output(do1-4), annlog quantity(Ao1-4), modify password(CodE) and LCD display hierarchical menu

framework management are provided in this instrument. Row 1 displays the first-tier menu; row 2 displays the second-tier menus; row 3 displays the parameter value.

First-tier menu	Second-tier menu	Parameter value	Description
CodeE		0~9999	Prompt the input programmable password is codE, and can only enter the programmable mode with correct password. (Factory Code:0001)
SEt	d,SP	0~10	Select display mode "diSP"
	b.Lcd	1~15	Adjust the bright of LCD, 15: brightest
	CLr.E	End	Pressing "Enter key" to clear the electric energy data of the instrument
InPt	nEt	n.3.4 n.3.3	Select input network "nEt", n.3.3: three-phase three-wire n.3.4: three-phase four-wire
	U.ScL	400V 100V	Select measuring range of voltage: 400V or 100V
	i.ScL	5A/1A	Select measuring range of current: 5A or 1A
	Pt	1~9999	Set multiplying power of voltage transformer (Primary value/second value of voltage transformer)
	Ct	1~9999	Set multiplying power of current transformer (Primary value/second value of current transformer)
Conn	Sn	1~247	Set RS485 communication address "Sn"
	bAUD	9600	Select communication baud rate "bAud": 1200, 2400, 4800 or 9600
	dAtA	n.8 1 o 8 1 E 8 1	Protocol form n.8.1: n-no check, 8-eight data bits, 1-one stop bit o.8.1: o-odd check, 8-eight data bits, 1-one stop bit E.8.1: e-even check, 8-eight data bits, 1-one stop bit
do-1	0~255	0~9999	Select the first-channel alarm output object, and set the higher and lower limit of alarm output range
Ro-1	0~255	0~9999	Select the first-channel transmitting output object, and set the higher and lower limit of transmitting output range
CodeE	oLd	0~9999	Current code
	n-1	0~9999	Input new code first time
	n-2	0~9999	Input new code second time

4.6 Programming operation examples

The measuring range of instruments has been set as the same parameters provided by users at the factory. Users should check if the input network, voltage/current measuring range and transformer multiplying power are consistent with the actual input again before use.

4.6.1 Set display mode, change the display mode from current to power factor.

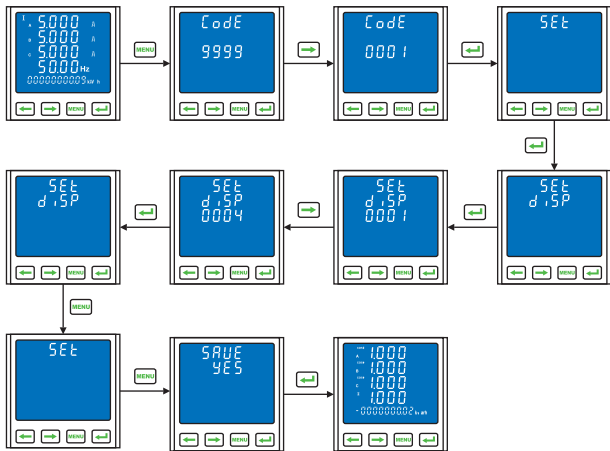

4.6.2 Set signal input net, change the net from n.3.4(3P4W) to n.3.3(3P3W), set multiplying power of current transformer is 60(CT 300A/5A)

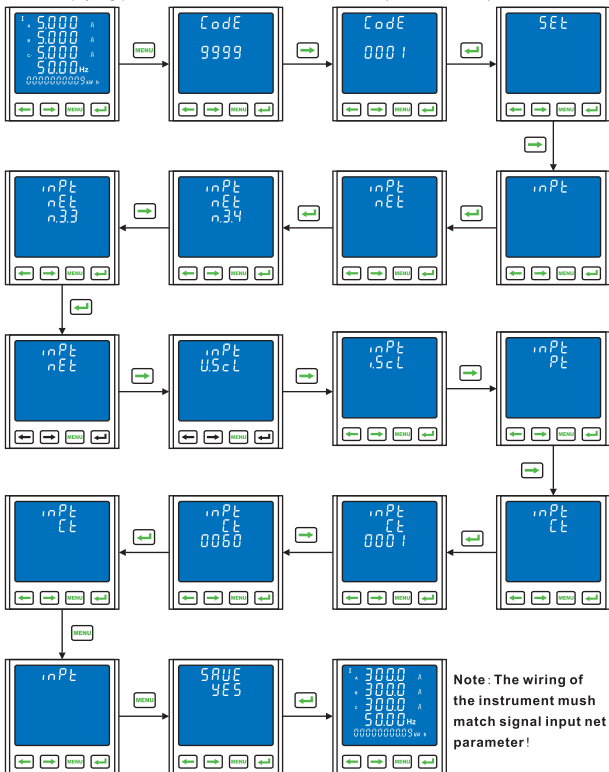

4.6.3 Modify the communication parameters: set Rs485 communication address "Sn": 10, select protocol form "DATA": E.8.1

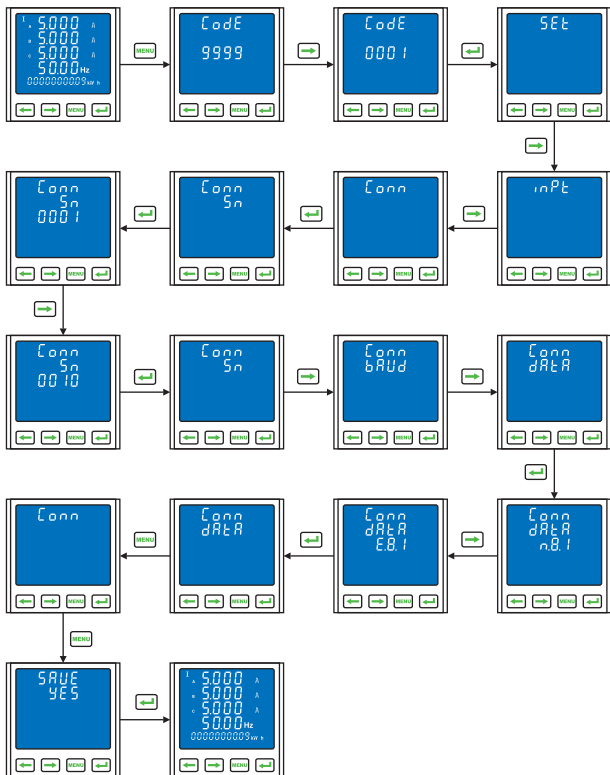

Chapter 5. Installment and wiring

5.1 Shape and cutout hole dimension(unit: mm)

Shape	Panel dimension		Case dimension			Cutout hole dimension	
	W	H	W	H	D	W	H
120×120Square	120	120	110	110	83	112	112
96×96Square	96	96	90	90	83	92	92
80×80Square	80	80	74	74	83	76	76
72×72Square	72	72	66	66	83	68	68

5.2 Method of installation

Choose the corresponding hole cutout dimension from the table above , make a hole in the installation screen, insert the instruments into the hole, place the four clamping pieces into the clamping holder and push and tighten them by hand.

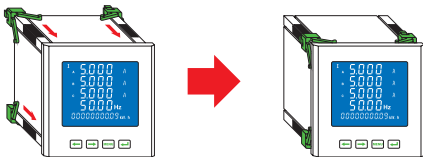

5.3 Wiring instructions

5.3.1 Terminal arrangement and function declaration of instrument(please accord to the one of instrument case)

Auxiliary power supply (POWER): AC 220V,50/60Hz(Can customize other values)

Electrical quantity signal input : A , B and C three-phase AC current or voltage signal input port, and I* is current live wire. When connect, please ensure the phase sequence and polarity of input signal respond with the terminals to avoid indicating value error. When the voltage is higher than the rated input voltage of the product,you should consider of using PT and installing fuse of 1A at the voltage input port; while the current is higher than rated input current of the product, you should consider of using the exterior CT

5.3.2 Typical connection

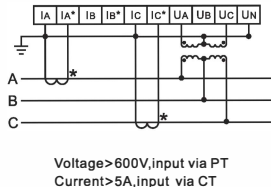
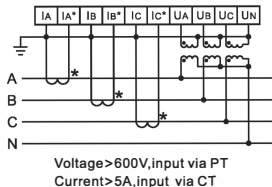
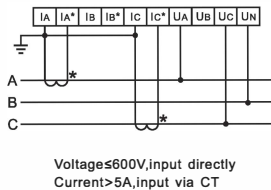
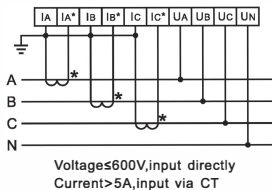
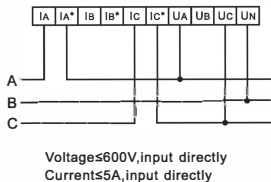
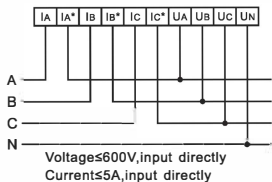

5.3.3 Energy signal output: P+ is the active energy pulse output + port, Q+ is the reactive energy pulse output + port, P-Q- are the active/reactive electrical pulse output port. Output mode: open-collector optical coupling output; open-collector voltage $V_{CC} \leq 48V$; current $I_z \leq 50mA$. The energy pulse output corresponds with these secondary data. When measuring the primary energy, it needs to multiply the PT multiplying power and CT multiplying power to get the primary data.

5.3.4 RS485 communication connection

The instrument supplies a RS485 communication interface and applies

MODBUS_RTU communication protocol (see the appendix). Up to thirty-two instrument can be connected in one communication line at one time. Each instrument should have the only communication address in the circuitry. Communication connection should use the shielded twisted paired with copper mesh, whose diameter should be not less than 0.5mm. Communication line should be far away from the high-voltage cables or other highfield environment and the maximum transmission distance is 1200 m. The typical network connections are shown in the following figure and users can choose other suitable connect mode under specific conditions.

5.3.5 Switching value input(DI input):DI1~DI4 are 1~4 way dry contact input port, inside of the instrument there is power supply of +5V.

5.3.6 Switching output and analog transmitting output: can support four-channel switching value output and four-channel analog transmitting output.

Chapter 6. Communication protocol

6.1 This series instrument are provided with Rs485 communication interface and apply MODBUS_RTU communication protocol.

Start	Address code	Function code	Data sector	CRC code	End
Halt time more than three bytes	1byte	1byte	Nbyte	2byte	Halt time more than three bytes

6.2 Communication message transmitting process

When communication instructions transmit from master device to slave device, the slave device with corresponding address code receives communication orders and reads the message according to functional code and relational requirements. After successful CRC verification without error, the corresponding operation will be conducted and the result (data), including address code, function code, data after execution and CRC verification code, is returned to the master device. In case of CRC verification failure, no message would be returned.

6. 2. 1 Address code:

Address code is the first byte (8 bits) of each communication message frame, from 1 to 247. Every slave device must have the only address code and only the slave device conforming to the address code can respond and return the message. When the slave device returns the message, all of the return data start with each

address code. The address code sent by master device shows the receiving address of slave device, while the address code returned by slave device shows the returning slave address. The responding address code shows where the message comes from.

6. 2. 2 Function code

Function code is the second byte of each communication message frame. The master device sends and tells that what operation the slave device should carry out by means of function code. Then the slave device responds. The functional code returned by slave device is the same as the one sent by master device, which shows that slave device has responded the master device and carry out the relational operation. The instrument supports three function codes as following:

Function code	Definition
03H/04H	Read register
05H	Remote control single relay operation

6.2.3 Data sector

Data sector are different following the different function code. These data could be numerical value, reference address and son on. For different slave device, the address and data information are different (There should be communication information table). The master device utilizes the communication order (Function code 03H) to read and amend the data register of the slave device. The data length read out or written in should not exceed the effective range of the data register address once.

6. 3 16-bit CRC verification code

Algorithm of CRC code:

6.3.1 Presetting a 16-bit register to hex FFFF (namely 1 for all bits in binary system).

The register is called CRC register;

6.3.2 XORing the first 8-bit binary data (the first byte of the communication message frame) with the low 8-bit of 16-bit CRC register, then storing the result in CRC register;

6.3.3 Right-shifting the register data by one bit (towards lower bit) and filling the highest bit with 0, then verification the shift-out bit;

6.3.4 If the shift-out bit is 0, repeat step 3 (right-shifting one more bit); If the shift-out bit is 1, XOR the CRC register data with polynomial A001 (1010 0000 0000 0001);

6.3.5 Repeating step 3 and step 4 until all of the 8-bit data have been processed after 8 right-shift operations;

6.3.6 Repeating step 2 to step 5 to process the next byte of the communication message frame;

6.3.7 When calculation procedures of the first 5 bytes in the communication message frame are completed, the 16-bit CRC verification code will be generated in the 16-bit CRC register.

6.4 Message format instruction

6.4.1 Read data register value(Function code :03H/04H)

Master device request	Frame structure	Address code	Function code	Data code		Check code
				Starting register address	Register number	
	Bytes	1byte	1byte	2bytes	2bytes	2bytes
	Data range	1~247	03H/04H		≤25	CRC
Example	01H	03H	00H,46H-48H	00H,03H	79H,C9H	
Slave device response	Frame structure	Address code	Function code	Data code		Check code
				Starting register address	Register number	
	Bytes	1byte	1byte	1byte	Nbytes	2bytes
	Data range	01H	03H	06H	(6bytes data)	(CRC)

The register address that the master device required is the first address of the data for required primary power grid or secondary power grid,the register quantity is the length of the required data.For example,the starting register address 03H, 46H-48H,it means the first address of the integer data of the three phase voltage. The register quantity 00H,03H means the length of the data is three word.Please take the form for the MODBUS_RTU communication address information as the reference.

6.4.2 Remote control single relay output (function code: 05H)

Master device request	Frame structure	Address code	Function code	Data code		Check code
				Starting relay address	Relay active value	
	Bytes	1byte	1byte	2bytes	2bytes	2bytes
	Data range	1~247	05H	0000H-0003H	FF00H,0000H	CRC
Example	01H	05H	00H,00H	FFH,00H	8CH,3AH	
Slave device response	Frame structure	Address code	Function code	Data code		Check code
				Starting relay address	Relay value	

Slave device response	Bytes	1byte	1byte	1byte	2bytes	2bytes
	Data range	01H	05H	00H,00H	FFH,00H	8CH,3AH

The relay operating value that the master device required FF00H means closed, 0000H means cut off. Using cutting off, using remoting order, must set the relay at the remoting control mode.

6.5 MODBUS_RTU address information form (the address is demonstrated with decimal system)

Modbus address	Parameter code	Description	Explanation	
Programming information				
0	Code	Programming password	1~9999	
1	xs	Display mode	1byte	
	dz	Communication address	1byte, 1~247	
2	PT	Multiplying power of potential transformer	1~9999	
3	CT	Multiplying power of current transformer	1~9999	
4~6	Reserve			
Switch value output, analog quantity output				
7	DO1-Addr	Switch value output 1	Chapter 8. Switchvalue module	
8	DO1-Data			
9	DO2-Addr	Switch value output 2		
10	DO2-Data			
11	DO3-Addr	Switch value output 3		
12	DO3-Data			
13	DO4-Addr	Switch value output 4		
14	DO4-Data			
15	AO1-Addr	Analog quantity output 1		Chapter 9. Analog quantity module
16	AO1-Data			
17	AO2-Addr	Analog quantity output 2		
18	AO2-Data			
19	AO3-Addr	Analog quantity output 3		
20	AO3-Data			
21	AO4-Addr	Analog quantity output 4		
22	AO4-Data			

23~46	Reserve		
Power sign information			
47	SING	Power sign bit	
Data of switch value and electrical quantity			
55	DI	Switch value input	Switch value input part
56	DO	Switch value output	Switch value output part
57, 58	UA	A-phase voltage	2 bytes (4 bytes) floating-point representation data, IEEE-754 data format standard. All data is primary data, then by the ratio of the value. The unit of voltage V, The unit of current A, active power unit KW, reactive power unit Kvar, apparent power unit KVA, the unit of frequency Hz.
59, 60	UB	B-phase voltage	
61, 62	UC	C-phase voltage	
63, 64	UAB	AB-line voltage	
65, 66	UBC	BC-line voltage	
67, 68	UCA	CA-line voltage	
69, 70	IA	A-phase current	
71, 72	IB	B-phase current	
73, 74	IC	C-phase current	
75, 76	PA	A-phase active power	
77, 78	PB	B-phase active power	
79, 80	PC	C-phase active power	
81, 82	PS	Total active power	
83, 84	QA	A-phase reactive power	
85, 86	QB	B-phase reactive power	
87, 88	QC	C-phase reactive power	
89, 90	QS	Total reactive power	
91, 92	SA	A-phase apparent power	
93, 94	SB	B-phase apparent power	
95, 96	SC	C-phase apparent power	
97, 98	SS	Total apparent power	
99, 100	PFA	A-phase power factor	
101, 102	PFB	B-phase power factor	
103, 104	PFC	C-phase power factor	
105, 106	PFS	Total power factor	
107, 108	FR	Frequency	
109~128	Reserve		

electric energy information			
129, 130	WPP	Primary positive active energy	2 bytes (4 bytes) floating-point representation data, IEEE-754 data format standard. All data is primary data, then by the ratio of the value. The unit of voltage V, The unit of current A, active power unit KW, reactive power unit Kvar, apparent power unit KVA, the unit of frequency Hz.
131, 132	WPN	Primary opposite active energy	
133, 134	WQP	Primary positive reactive energy	
135, 136	WQN	Primary opposite reactive energy	
137, 138	EPP	Secondary positive active energy	
139, 140	EPN	Secondary opposite active energy	
141, 142	EQP	Secondary positive reactive energy	
143, 144	EQN	Secondary opposite reactive energy	

Note: Description of data format

Data type “float” :four-byte floating data, apply IEEE-754 standard. The level code and mantissa express the magnitude of number. The description according to byte is as following:

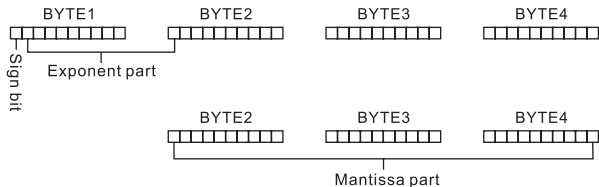

Sign bit: SIGN=0 is poative, SIGN=1 is oppsite;

Exponent part: $E = \text{Exponent part} - 126$;

Mantissa parts: M = mantissa parts make up the highest bit is 1;

Data results: $\text{REAL} = \text{SIGN} \times 2^E \times M / (256 \times 65536)$.

For example: energy data which read from the address table to know electric energy (positive active absorption) is: (Byte mode, compatible with the old standard) 92 (005CH) length of 4 (0004H).

Master divice: 01H 04H 00 5CH 00 04H 31 DBH

Slave divice: 01 04H 04H 50 80 00 00H EBH 6CH(50 80 00 00 is active energy, EBH, 6CH is low byte and high byte of CRC verification code)

Data representation: SIGN (sign bit = 0, positive), Exponent part: EX = A1H - 126 = 35,

Mantissa part: 08 00 00H

Electric energy: $2^{35} \times 80.00 \text{ 00H} / 100 \text{ 00 00H} = 17179869184 \text{ Wh} = 17179869 \text{ KWh}$

6.6 Communication messages Example

Read the three-phase current from the terminal device : address is 1 (01H)

Inquire data frames(master device)

Address code	Function code	Address of start register		Register quantity		CRC verification code	
		High byte	Low byte	High byte	Low byte	Low byte	High byte
01H	03H	00H	45H	00H	06H	D4H	1DH

Respond to data frames (master device)

Address code	Function code	Byte number	Data1~12	CRC verification code	
				Low byte	High byte
01H	03H	0CH	43556680H, 43203040H, 42DDCC80H	D4H	1DH

Indicate: IA=43556680H(213.4A)、IB=43203040H(160.1A)、IC=42DDCC80H(110.8A)

Chapter 7. The Electric Energy Pulse

The multifunctional network Power instrument provides active and reactive energy measurement, 2-way power pulse output and RS485. The digital interface completes energy data display and rhomboides. 10 digits LCD display the active energy (positive) Reactive energy (inductive) measured data; open collector optocoupler relay power pulse (Resistance signal) achieves active power (positive) and reactive power (reverse) Remote, a remote computer using the final End, PIE, DI switch acquisition module, collecting instrument to achieve the total energy accumulated pulse measurement. The use of output or the output power accuracy test methods (national measurement procedures: the standard table Pulse error ratio method).

7.1 Electrical Characteristics: open collector voltage $VCC \leq 48V$, current $I_z \leq 50mA$.

7.2 Pulse constant: 3200imp/KWh. Its meaning is: When the instrument outputs a pulse when the accumulation of 1KWh. Number 3200, should be emphasized that 1KWh 2 test for the electricity energy data, in PT, CT of the Case, the relative pulse data corresponding to the N-1 measured power for the $1KWh \times PT \times CT$.

7.3 Application examples: PLC terminal using the pulse counting device, assuming that the length of time taken T Set number of pulses into N, instrument input: 10KV/100V, 400A/5A, the period instrument . Table electricity accumulation: $N/3200 \times 100 \times 80$ -degree power.

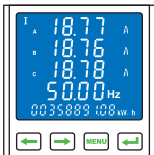

Positive active electric energy:
35889.108KWh

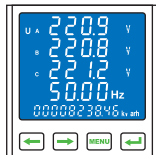

Positive reactive electric energy:
8238.46Kvarh

Chapter 8. Switch value module

The instrument offers 4 channels switch value input function and 4 channel opto-couple relay's switch value output function. 4 channels switch value input adopt the way of dry node resistor switch signal input. When it is connected for external part, the module DI via instrument switch input will collect the connecting information and display as 1; when it is disconnected for the external part, the module DI via instrument switch input will collect the disconnecting information and display as 0. The switch value input module can not only collect and display the local switch information, but also can realize the remote transmitting function with the instrument's RS 485 digital connecting interface, it is function of "remote signalling". The switch value output function of 4 channel opto-couple relay, can be used as the alarm caution, output function for protect controlling and so on. When the switch value is effective, relay output is opening and switch value is closed, the relay output will be closed also.

Electric parameter: Switch value input DI: connecting resistor $R > 100K\Omega$, Switch value output DO: AC 250V, 0.1A

Register: DIO information register: this register show the status information for 4 channel switch value and 4 channel switch value output.

DIO Register	BIT7	BIT6	BIT5	BIT4	BIT3	BIT2	BIT1	BIT0
Switch port	DO4	DO3	DO2	DO1	DI4	DI3	DI2	DI1
Reposition	0	0	0	0	0	0	0	0

The low 4 byte of the DIO register (BIT3, BIT2, BIT1, BIT0) is the status information for switch value input. If the register display as 0000 0101, it means the channel DI3 and DI1 for switch value input is closed; channel DI4 and DI2 is cut off.

The high 4 byte of the DIO register(BIT7,BIT6,BIT5,BIT4)is the status information for switch value output.If the register display as 1101 000,it means connect with channel DO4, DO3 and DO1;disconnect with channel DO2 . The DIO information can be displayed on the LCD screen of the instrument.

8.1 Examples

8.1.1 Switch value input function:

The switch module has the collecting function for 4 channels switch input.When collecting is inputed the signal,the instrument's LCD screen may display "-1 open" or "-0 closed". This is used as the local supervisor for the switch signal.Change the instrument to the display status of the switch information,the last four digits of the lowest row on the LCD screen display the status information of switch input.From the left to the right,it is channel 4,channel 3,channel 2 and channel 1. With the RS 485 interface,the users can transmitting the switch register's information to the remote computer's terminal.The picture on the right shows: Channel 4,2 and 1 are closed;Channel 3 is cut off.

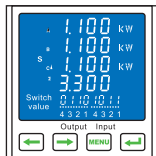

Channel 4,2 and 1 are closed;Channel 3 is cut off.

8.1.2 Switch value output function:

The picture shows the channel 4 and 1 are cut off.;channel 3 and 2 are closed.

The another function of the switch value output module is off-limited alarm output. Set the range for the parameters.When the parameter is off-limited the range, the corresponding switch value output interface is open,the screen will display 1. When the signal is in the range,the screen will display 0.

The setting for switch value parameters DOI can also be realized via key programming. See the right picture: The first line showing DO-1 means the item setted is switch value output module 1;Line 2 showing 0007 is the alarm item, 7:IA low alarm.Line 3 showing 2000 means the area of the alarm,when the IA<2000,DO 1 output alarm signal,as relay is open.



Switch value output and analog quantity output electric quantity parallel table

Project	Switch value output		analog quantity output	
	Corresponding parameter (lower alarm)	Corresponding parameter (higher alarm)	Corresponding parameter (0~20mA)	Corresponding parameter (4~20mA)
UA(A-phase voltage)	1	129	1	129
UB(B-phase voltage)	2	130	2	130
UC(C-phase voltage)	3	131	3	131
UAB(AB-line voltage)	4	132	4	132
UBC(BC-line voltage)	5	133	5	133
UCA(CA-line voltage)	6	134	6	134
IA(A-phase current)	7	135	7	135
IB(B-phase current)	8	136	8	136
IC(C-phase current)	9	137	9	137
PA(A-phase active power)	10	138	10	138
PB(B-phase active power)	11	139	11	139
PC(C-phase active power)	12	140	12	140
Ps(Total active power)	13	141	13	141
QA(A-phase reactive power)	14	142	14	142
QB(B-phase reactive power)	15	143	15	143
QC(C-phase reactive power)	16	144	16	144
QS(Total reactive power)	17	145	17	145
PFA(A-phase power factor)	18	146	18	146
PFB(B-phase power factor)	19	147	19	147
PFc(C-phase power factor)	20	148	20	148
PFs(Total power factor)	21	149	21	149
SA(A-phase apparent power)	22	150	22	150
SB(B-phase apparent power)	23	151	23	151
Sc(C-phase apparent power)	24	152	24	152
Ss(Total apparent power)	25	153	25	153
F(frequency)	26	154	26	154

Alarm parameter calculation method:

Numerical calculation of electrical parameters of alarm limits: take the range 's highest value 4 number, get a 4 bit integer ratio. The alarmValue and range of

values is equal to a set value and reference value ratio

$$\text{Set value} = \frac{\text{Alarm value} \times \text{Reference value}}{\text{Range value}}$$

If the instrument's parameters are 400V, 800A/5A

Setting requirements	Alarm condition	Range value	Reference value	Programming parameters	
				Electricity parameters	Set value
Voltage alarm	UA>400V	400	4000	129	4000
	UB>430V			130	4300
	UC<80V			3	800
Current alarm	IA>800A	800	8000	135	8000
	IB<400A			8	4000
	IC<70A			9	7000
Power alarm	PA>320KW	320K	3200	138	3200
	PS>980KW	960K	9600	141	9800
	PS<560KW			13	5600
Power factor alarm	PFA>0.866	1	1000	146	866
	PFS>0.9			149	900
	PFS<0.5			21	500

Chapter 9. Analog transmitting output module

The instrument can offer the function of four-channel analog transmitting output. Each channel can choose to set any of the 26 parameters, with the instrument's function for analog transmitting output module, to reach the function of parameter's analog transmitting output(0-20mA/4-20mA). The corresponding relation can be set at random.

9.1 Parameter: output 0-20mA, 4-20mA, class: 0.5

Overload: 120% effective output, the maximum current: 24mA, the maximum volt: 16V
Load: Rmax=400Ω

9.2 Application example

For 10KV/100V, 400A/5A instrument settings: AO1-UA: 0~10KV/4~20mA; AO2-IA: 0~400A/4~20mA; AO3-PS: 0~12MW/0~20mA; AO4-QS: 0~12MVar/0~20mA;

Classification	Analog transmitting output	Control word (high byte first)		
		BYTE2	BYTE1	BYTE0
Analog transmitting output1	UA:4~20mA	128+1=129	1000(03HE8H)	
Analog transmitting output2	IA:4~20mA	128+7=135	4000(0FHA0H)	
Analog transmitting output3	PS:0~20mA	13	1200(04HB0H)	
Analog transmitting output4	QS:0~20mA	17	1200(04HB0H)	

The electrical parameters of transmitting output values are calculated from range: the top 4 bits of the number, a 4 bit integer ratio. Then the transmitting value and range value ratio is equal to the set value and reference value ratio.

$$\text{Set value} = \frac{\text{Transmitting value} \times \text{Reference value}}{\text{Range value}}$$

Note: when the transmission value errors, modify the corresponding set value.

If the instrument's parameters are 400V, 800A/5A

Setting requirements	Transmission condition	Range value	Reference value	Programming parameters	
				Electricity parameters	Set value
Voltage transmitting	UA:0~400V/4~20mA	400	4000	129	4000
	UB:0~420V/4~20mA			130	4300
	UC:0~350V/0~20mA			3	3500
Current transmitting	IA:0~800A/0~20mA	800	8000	7	8000
	IA:0~800A/4~20mA			135	8000
	IB:0~900A/4~20mA			136	9000
Power transmitting	PA:0~320KW/0~20mA	320K	3200	10	3200
	PS:0~960KW/4~20mA	960K	9600	141	9800
Power factor transmitting	PFA:0~1/0~20mA	1	1000	18	1000
	PFS:0~0.9/4~20mA			19	900

The users may set the parameters for the transmitting output via the plate key-pressing setting. In the programming operation, AOSI menu item is the transmitting module parameter setting parameter. See the right picture for parameter setting, programming item AO-1: transmitting output channel 1; 0129=128+1: choose

the UA as 4-20mA as the transmitting output, and the corresponding volt for 20mA is 10KV, setting as 1000.

For example, in the internet 10KV/100V, the transmitting output function is finished as: transmitting output loop 1, UA:0-10KV/4-20mA.



Chapter 10. FAQ and Solutions

10.1 About the inaccuracy measuring for the U, I, P and so on

Firstly, the users have to be sure that the right volt and current signal have already reach to the instrument. The users may use the multimeter to test the volt signal, or if needed, use pincerlike meter to test the current signal. Secondly, make sure the connecting of the signal line is correct, for example the leading-in interface for the current signal; check each phase sequence is right. The instrument can view the power display, only if the reverse electricity input, the active power will be in minus while the active power symbol will be plus if the instrument used normally. If the active power symbol is minus, it may means the wrong connecting for current leading-in line or the wrong connecting of the phase sequency. Another thing should be noted that the electricity value the instrument displayed is primary Grid values. If the set for the PT and CT rate of the instrument is different from the actual used rate, the instrument may also display the wrong electricity value.

10.2 About the inaccuracy energy read, energy data not saved

The energy accumulated value of the instrument is based on the power measuring. Check firstly whether the instrument's power value is conforming to the actual load. The instrument support the bidirectional energy computation. With the wrong connecting and minus total active power, the energy will accumulate to the reverse active energy and the positive active energy not. The problem appearing most is the wrong connecting for the CT leading-in line and leading-out line. If the energy data fails to be saved, please check whether there is any load for the instrument. Counting the load, the instrument will keep accumulating.

10.3 The instrument isn't lighting

Make sure suitable auxiliary power has already added to the instrument's auxiliary power interface. The volt exceeding the auxiliary power may damage the instrument and can not be recovered. The users can use the multimeter to test the volt value of the auxiliary power. If the power volt tests fine and there is nothing displayed on the screen of the instrument, the users may consider about cutting off the electricity and connecting it again. If the instrument still doesn't display normally, please contact with our technical department.

10.4 About RS 485 communication, there is no returning data from the instrument

Firstly, make sure the instrument's communicating setting information, such as the slave device's address, baud rate, checking ways is confirming to the core device. If there is more than one instrument that doesn't have the data returned, please check the connecting of main communicating line is right and also the RS 485 converter works fine. If there is only one instrument or few instrument communicate exceptionally, the users should also check the relevant communicating lines. Excluding or confirm the core device software problem with the way to modify the exception situation and slave device address. Or excluding or confirm the instrument problems with the way of testing the exception and instrument installation address.