

EInet LTE

Electrical Measurements & Power Quality

Rev. 1.6

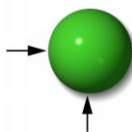

CONTROL APPLICATIONS Ltd.

Supervision & control system

Tel: +972-3-6474998 Fax: +972-3-6474598 24a Habarzel St. Tel-Aviv, 69710, Israel

Table of Contents

CHAPTER 1 – INTRODUCTION.....	5
1.1 — About the <i>ElNet LTE</i> Energy Powermeter ...	5
1.2 — How to use this manual.....	6
1.3 — Safety Information	8
1.4 — Warranty.....	9
1.5 — Your comments are welcome	11
1.6 — Disclaimer	12
CHAPTER 2 — INSTALLATION.....	13
2.1 — Contents of packaging	14
2.2 — Mechanical mounting	15
2.3 — Wiring Schematics	17
2.4 — Rear Panel Connections.....	18
2.5 — Digital Outputs and Inputs.....	21
2.6 — Manufacturing Data.	22
CHAPTER 3 — USING <i>ElNet LTE</i> POWERMETER ..	23
3.1 — Front Panel	23
3.2 — Control Buttons.....	24
3.3 — Lock Utility.....	25

CHAPTER 4 — NECESSARY Elnet LTE SETTINGS..26

4.1 — Settings for Current/Voltage Transformer29

4.2 — Change language30

4.3 — Setting energy pulse out.....31

4.4 — Setting no-volt32

4.5 — Setting cheack phase order.....33

CHAPTER 5 — FRONT PANEL DISPLAYS34

5.1 — Current Voltage & Frequency34

5.2 — Reset I , V , F Peak values.....36

5.3 — Power Display36

5.3.1 — Real time power display36

5.4 — Power Quality38

5.5 — Energy Metering39

CHAPTER 6 — COMMUNICATION.....40

6.1 — MODBUS Framing40

6.1.1— RTU Transmission Mode40

6.1.2 — The RTU Frame Format.....41

6.1.3 — Address Field42

6.1.4 — Function Field42

6.1.5 — Data Field43

6.1.6 — Check Field.....43

6.2 — Registers for EInet LTE Powermeter	44
6.2.1 — Registers addresses	45
6.3 — Communication Connections	45
6.4 — Communication Settings.....	46
6.4.1 — Communication Address	46
6.4.2 — Baud Rate	46
6.4.3 — Parity.....	46
6.5 — Communication Set Up.....	47
6.5.1 — Set up Serial Communications.....	47
6.6 — Communication with UniArt Software	48
CHAPTER 7 — Specifications	49
7.1 — Measurement & Display	50
<i>Index.....</i>	<i>51</i>
<i>Appendix A — Installation & Configuration Check List...51</i>	

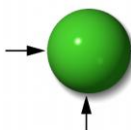

CHAPTER 1 – INTRODUCTION

1.1 — About the *ELNet LTE* Energy Powermeter

Large consumers of electricity e.g. factories, hotels, hospitals, municipalities, need to know the history of their consumption and the quality and the values of the power supply. Details such as Voltage, Current, Power Factor, Hertz, Neutral Current, Energy consumption can be displayed by the *ELNet LTE* Energy & Powermeter.

An additional feature of the Powermeter is the ability to measure THD – Total Harmonics Distortion. Part of the Electricity Supply Authority's bill reflects poor or good Harmonics in the consumer's system, therefore it is in his interest to monitor Harmonics and try to improve it.

The *ELNet LTE* Energy & Powermeter is a compact, multi functional, three-phase Powermeter simple to install and is especially designed to integrate into Building Management Systems. It requires no special mounting and is ideally suited for mounting on the front face of any standard electrical panel.

The Configuration and Setup is menu driven, with password protection.

Communication with external devices is simple and is based on standard known protocol.

Each *ELNet LTE* Energy & Powermeter is carefully and meticulously manufactured using quality components and the latest production methods. Before leaving the factory each *ELNet LTE* Energy & Powermeter is calibrated and is sent to the customer accompanied by the test certificate and Certificate of Compliance (C.O.C).

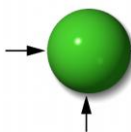

1.2 — How to use this manual

We at CONTROL APPLICATIONS Ltd, envisage this manual to be used by three types of people, i.e. the *Installation Technician*, the *Senior Electrical Engineer* and the end *User*. For this reason this manual is divided into chapters for ease of reference by each of these different people. There could be a situation where two of the above mentioned tasks can be combined, or in a rare instance one person could handle all three tasks.

CHAPTER 1, *Introduction*, describes the ***ELNet LTE*** Energy & Powermeter, its potential users, the readings it can provide and some of its features in brief.

CHAPTER 2, *Installation*, provides detailed instructions for unpacking, mechanical mounting, and electrical wiring up instructions for the *Installation Technician*.

CHAPTER 3, *Using the ELNet LTE* Energy & Powermeter, describes in detail front Panel, the functions of the control buttons, and the Lock Utility.

CHAPTER 4, *Parameter Configuration & Settings* explains in detail the minimum parameters settings needed by the *Senior Electrical Engineer* to set up and configure the ***ELNet LTE*** Energy & Powermeter.

CHAPTER 5, *Front Panel Displays*, is an easy to follow step-by-step guide to obtain readings, graphs and tables.

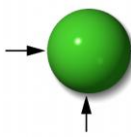

CHAPTER 6, *Communications* provides details about the Communication capabilities of the ***ELNet LTE*** Energy & Powermeter, and how to Set Up.

CHAPTER 7, *Specifications*, is a detailed list of specifications of the ***ELNet LTE*** Energy & Powermeter.

APPENDIX A, *Installation & Configuration Check List*, provides a Check List to insure no important steps will be missed during the initial set up.

1.3 — Safety Information

The purpose of this manual is to help you. Please read the instructions carefully before performing any installation and note any precautions.

WARNING!

- Ensure that all incoming AC power and other power sources are turned off before performing any work on the ***EINet LTE*** Energy & Power Powermeter. Failure to do so may result in serious or even fatal injury and/or equipment damage.
- If the ***EINet LTE*** Energy & Powermeter is damaged in any way do NOT connect it to any power source.
- To prevent a potential fire or shock hazard, never expose the ***EINet LTE*** Energy & Powermeter to rain or moisture.
- Keep the surrounding area free of dirt and clutter especially metal objects. Good housekeeping pays.
- Inspect the cables periodically for cracks, kinks or any other signs of wear.
- Keep children away.
- Do not pull the cords.

- Users should stay alert and not approach the rear of the ***ElNet LTE*** Energy & Powermeter while tired or under the influence of alcohol, medicines or any other chemical substance that would tend to make a person drowsy.
- Above all use common sense at all times.

1.4 — Warranty

CONTROL APPLICATIONS Ltd provides a 12- Month warranty against faulty workmanship or components from date of dispatch under the condition that the product was properly installed and used.

CONTROL APPLICATIONS Ltd does not accept liability for any damage that may be caused by natural disasters (such as floods, fire, earthquake, lightning etc.).

CONTROL APPLICATIONS Ltd does not accept liability for any damage that may be caused by malfunction of the ***ElNet LTE*** Energy & Powermeter.

CONTROL APPLICATIONS Ltd will advise the customer on the proper installation and use of the ***ElNet LTE*** Energy & Powermeter, but will not accept any responsibility that the instrument is suitable for the application for which it was originally purchased.

This warranty may become void if the Installation, Parameter Configuration & Setting Instructions are not carried out according to the instructions set out by CONTROL APPLICATIONS Ltd.

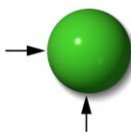

The ***ELNet LTE*** Energy & Powermeter has no user serviceable parts and should be opened and serviced by a duly qualified authorized representative only. The sensitive electronics could become damaged if exposed to a static environment. This action would void the warranty.

This warranty is limited to the repair and/or replacement at CONTROL APPLICATION Ltd sole discretion of the defective product during the warranty period. Repaired or replaced products are warranted for ninety (90) days from the date of repair or replacement, or for the remainder of the original product's warranty period, whichever is longer.

CONTROL APPLICATIONS Ltd is always at your service to advise the customer on any problem that may be encountered regarding any installation, operation, parameter & configuration settings or maintenance.

1.5 — Your comments are welcome

CONTROL APPLICATIONS Ltd. sincerely thanks you for choosing our ***ELNet LTE*** Energy & Powermeter. We are confident that it will provide you with many years of trouble free service and give you all the power and energy information and history that you expected from the instrument when you bought it.

While every effort was made to keep the information as reliable, helpful, accurate and up to date as possible, all possible contingencies cannot be covered. Technical or typographical errors could occur, and we would be happy to receive any comments, criticisms or notifications of any such errors from you, our valued customer.

Address:	Control Applications ltd 24A HaBarzel St. Tel-Aviv 69710 Israel Tel: 972-3-647-4998 Fax: 972-3-647-4598
Electronic Address:	cal@ddc.co.il

1.6 — Disclaimer

Information in this User Manual is subject to change without notice and does not represent a commitment on the part of CONTROL APPLICATIONS Ltd.

CONTROL APPLICATIONS Ltd supplies this User Manual as is without warranty of any kind; either expressed or implied, and reserves the right to make improvements and/or changes in the manual or the product at any time.

While it is the intention of CONTROL APPLICATIONS Ltd to supply the customer with accurate and reliable information in this User Manual, CONTROL APPLICATIONS Ltd assumes no responsibility for its use, or for any infringement of rights of the fourth parties which may result from its use.

This User Manual could contain technical or typographical errors and changes are periodically made to the information herein; these changes may be incorporated in new editions of the publication.

CHAPTER 2 — INSTALLATION

In this Chapter you will find the information and instructions that the *Installation Technician* needs to mount and connect the

ElNet LTE Energy & Power Powermeter

WARNING!

- During operation, hazardous voltages are present in connecting cables and terminal blocks.
- Fully qualified personnel must do all work. Failure to follow this rule may result in serious or even fatal injury to personnel and/or damage to equipment.
- Refer to Section 1.3 Safety information before carrying out any installation.
- Read this manual thoroughly and make sure you understand the contents before connecting the *ElNet LTE Energy & Powermeter* to any power source.

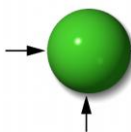

2.1 — Contents of packaging

To unpack the *ELNet LTE* Energy & Power Powermeter

The *ELNet LTE* Energy & Powermeter is packed and shipped in a carton approximately 11 cm long X 11 cm wide X 10.5 and cm high.

Before opening the package, ensure the area, clean and dry.

Without using any sharp instruments, carefully open the carton of the *ELNet LTE* Energy & Powermeter.

Please check the contents of the carton, it should contain:

1. New *ELNet LTE* Energy & Powermeter.
2. *ELNet LTE* User Manual (This book).
3. Test Certificate and Certificate of Compliance (C.O.C).
4. 1 X two pole connector plug.
5. 1 X three pole connector plug.
6. 1 X six pole connector plug.

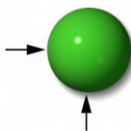

2.2 — Mechanical mounting

To Mount the *ELNet LTE* Energy & Powermeter

NOTE!

Do not mount the *ELNet LTE* Energy & Powermeter too close to any main electrical conductors

Allow sufficient space to carry out maintenance to the back of the *ELNet LTE* Energy & Powermeter

1. Choose a suitable location, and prepare a rectangular hole according to the dimensions shown in Figure 2.1

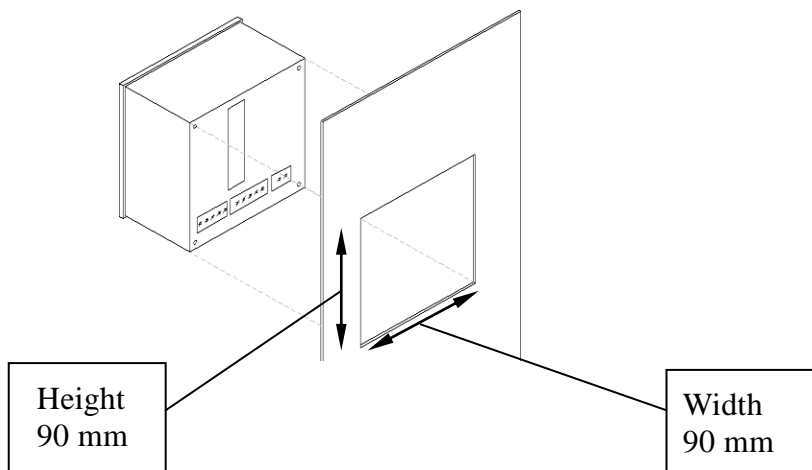
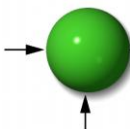

Figure 2.1 Panel Cutout



2. Slide the ***ELNet LTE*** Energy & Powermeter into the pre-prepared rectangular hole (ensure it is the right way up), then push the four mounting clips into position. Use mild force to ensure the clips are securely positioned on the outer case of the ***ELNet LTE*** Energy & Powermeter.
3. Ensure the ***ELNet LTE*** Energy & Powermeter is firmly in place.

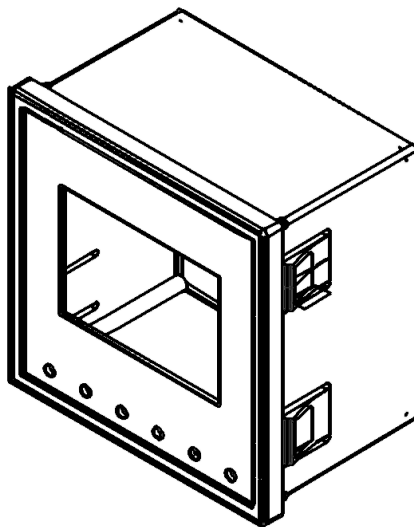
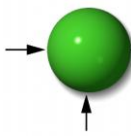

Figure 2.2 Mounting Clips



2.3 — Wiring Schematics

To wire up the *EINet LTE* Energy & Powermeter

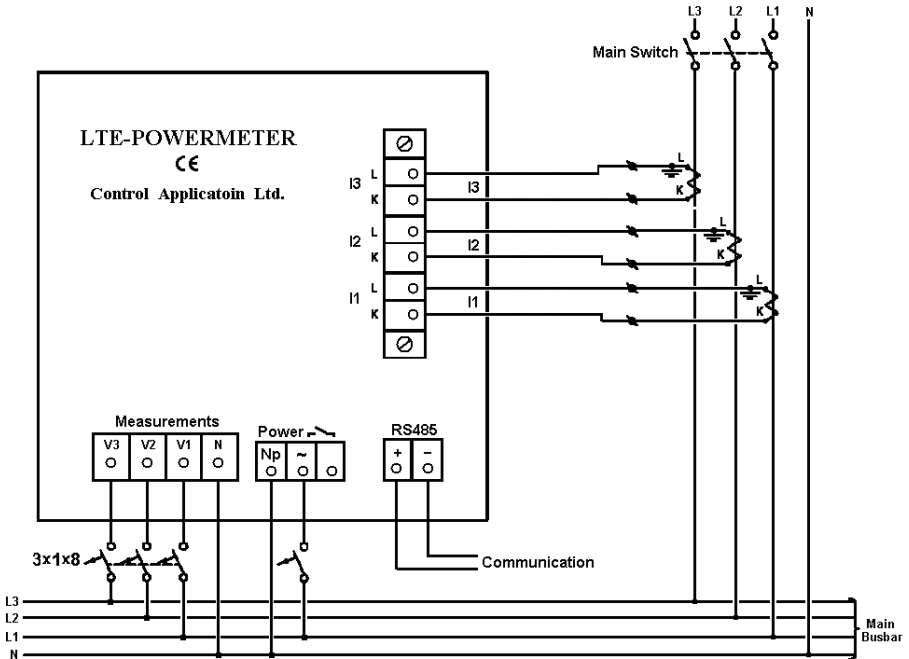
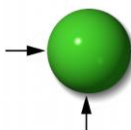

Figure 2.3 Schematic Wiring Diagram "Star" connection



2.4 — Rear Panel Connections

Please re-read section 1.3 for safety instructions.

To connect the Rear Panel

All Connections of the *ELNet LTE* Energy & Powermeter are made via terminal connector plugs (Voltage input, Current input, Power Supply, Communication etc.).

Maximum recommended tightening torque for the connector screws is 0.5 Nm.

The current plugs must to connect in the correct direction.

NOTE!

Ensure all the connections to the leads of the current measurement inputs are secure and there is no mechanical strain on the wire. The cross section of the leads to the current transformer must be compatible to the power of the current transformer. We recommend a power transformer with at least 3VA and the length of the wiring of the transformer no longer than 3m.

Insert the leads from side “L” of the external Current Transformers to the ELNET current plug in side “L” and from side “K” of the ELNET current plug back to side “K” of the external transformers.

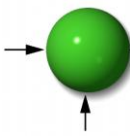

WARNING!

Never allow an open circuit between the two Current Transformer leads.

Repeat the procedure for **Line 2** and **Line 3**.

Connect the rest of the connections to the **ELNet LTE** Energy & Powermeter by means of terminal connector plugs.

The Rear Panel (See Figure 2.5) has all connections printed and is simple to follow. (See table 2.1 for connections)

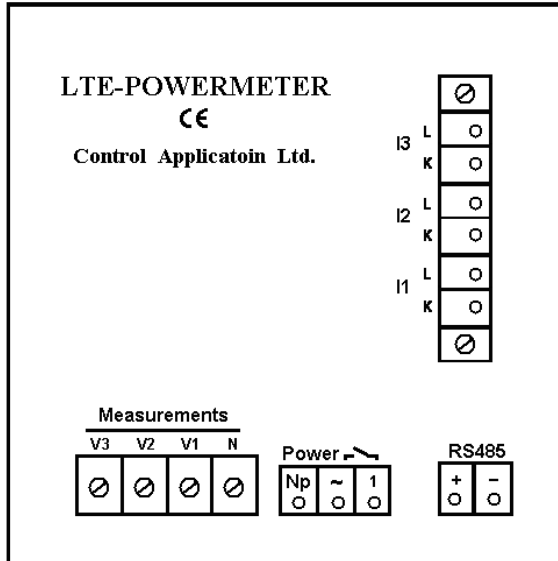
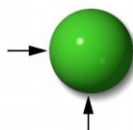
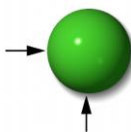

Figure 2.5 Rear Panel



Pin Designation	Description	Remarks
V₁	Line1 Supplied Voltage	Through a 6Amp fuse
V₂	Line2 Supplied Voltage	Through a 6Amp fuse
V₃	Line3 Supplied Voltage	Through a 6Amp fuse
N	Neutral	Measurement neutral Line
I_{1A}	From Current Transformer on Line1	Note the correct direction (L and K)
I_{2A}	From Current Transformer on Line2	Note the correct direction (L and K)
I_{3A}	From Current Transformer on Line3	Note the correct direction (L and K)
~	Power Supply 110 - 260 VAC	Or 110-260 VDC, external power supply or bridged from phase measurement
N_p	Neutral	Neutral of external power supply
RS485 -	RS485 Comm. (-) Line	
RS485 +	RS485 Comm. (+) Line	
	Digital Out	Max. Load 150 mA

Table 2.1 Rear Panel connections



2.5 — Digital Outputs and Inputs.

EUNet LTE Energy & Powermeter has as default 1 Digital Output connection at its back side.

Digital Output:

The Digital Output of the LTE can be used to transmit pulses of energy to external BMS controller (chapter 4.3), close contact upon no volt situation (chapter 4.4) or to close contact upon wrong phase order (chapter 4.5) which can be defined in the LTE (cannot be used for both simultaneously). The Digital Out closes contact between pin ~ (power supply input) and pin 1, the maximum load is 150mA.

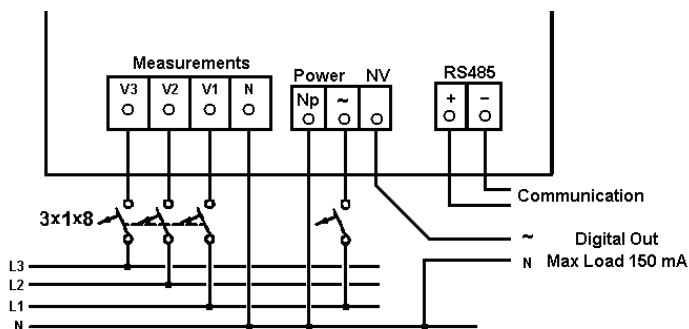
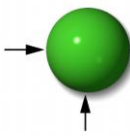

Figure 2.5 Digital Out wiring example



2.6 — Manufacturing Data.

Press F1 on the keyboard for 6 seconds. The following screen will appear.

System Information	
EP.DATE:	13/03/12
VERSION:	2.33
CT RATE (5A):	80
COMM #:	31

Figure 2.6 Manufacturing data

Number	Screen	Description
1	Ep. Date	Production date of software operating system
2	Version	Bios Revision
3	CT Rate	Current transformer ratio
4	Comm #	Communication address of RS485 Modbus

Table 2.2 Production Data

CHAPTER 3 — USING *ElNet LTE* POWERMETER

In this chapter you will find descriptions and functions of the front panel and the control buttons and how to use them.

3.1 — Front Panel

To operate the front panel

The Front Panel has a graphic screen and 6 operating buttons.

All the readings are shown on a state of the art 320 X 240 resolution graphic screen and are explained in detail in Chapter 5.

The Control Buttons and their functions are fully explained in Section 3.2.

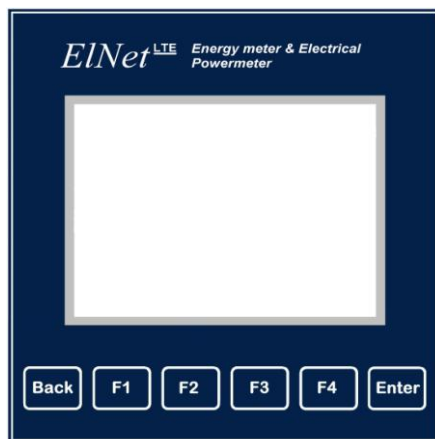

Figure 3.1 Front Panel

3.2 — Control Buttons

To operate the Control Buttons on Front Panel

The ***ELNet LTE*** Energy & Powermeter has six Control Buttons. With these buttons the *User* and *Senior Electrical Engineer* can achieve all the functions necessary.

The Control Buttons are arranged on a keypad below the display screen and require slight finger pressure to click.

Button “ENTER” accepts the choice and executes the commands.

Buttons “F1”, “F2”, “F3”, “F4” performs the function that the arrow above is pointing to (e.g. move the cursor), or selects the prompt that the arrow is pointing to.

Button BACK returns to the previous step or to the Main Menu.

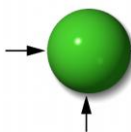

3.3 — Lock Utility

To lock and unlock the Control Buttons

The Control Buttons can be locked against any unauthorized or accidental usage.

NOTE!

Only sub menus can be locked. The Lock Utility does not work on the Main Menu

To lock press “ENTER” for six (6) seconds.

A “Keyboard Locked!” message appears on the screen when any button is pressed.

To unlock simply press “ENTER” for six (6) seconds.

A “Keyboard Unlocked!” message appears on the screen and normal functions can resume.

In the event of a general power failure, the ***ElNet LTE Energy & Powermeter*** will return to the screen that was showing before the power failure occurred.

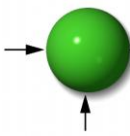

CHAPTER 4 — NECESSARY *ELNet LTE* SETTINGS

In this chapter you will find instructions to set the minimum settings that are necessary to allow the *ELNet LTE* Energy & Powermeter to function properly.

WARNING!

- The selection, installation and settings of the Current Transformer are the most vital and fundamental actions required to ensure the accuracy of the *ELNet LTE* Energy Powermeter.
- It is essential to know the ratio of the Current Transformer being installed into the system in order to set the parameter for the Current Transformer correctly.
- All three main current Lines MUST have Current Transformers of the same ratio installed onto them.

4.0 — Entering code

The most important setting necessary for the proper functioning of the ***ELNet LTE*** Energy & Powermeter is the Current Transformer setting.

The cross section of the leads to the current Transformer must be compatible to the power of the current transformer. We recommend a power transformer with at least 3VA and the length of the wiring of the transformer no longer than 3m.

- 1 From Main Menu scroll to **Technical Menu**.
- 2 Click “ENTER”.

The **Enter Code** screen appears

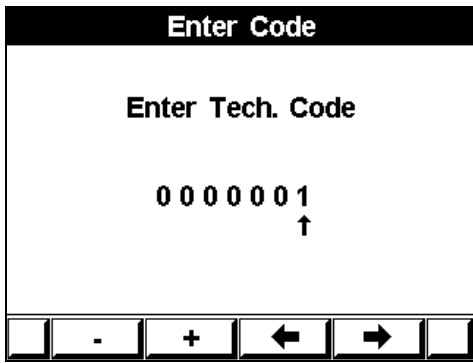
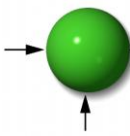

Figure 4.1 **Enter Password**

The password is 1.



- 3 Use the buttons F3 & F4 to move the cursor, to set the value use buttons F1 &F2.
- 4 Click "ENTER".

If the incorrect password is inserted into the Password field, an Error message appears and the password should be reentered

The **Technical Menu** screen appears

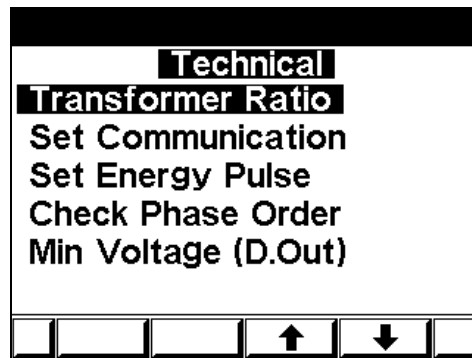
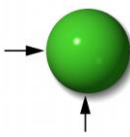

Figure 4.2 **Technical Menu**

Use the buttons F3 & F4 to move the cursor, selecting "NEXT" will lead you to more functions that can be set by the technician.



4.1 — Settings for Current/Voltage Transformer

To set or change settings for **Current/Voltage Transformer**

See Section 4.0 for instructions to arrive at the **Technical Menu**

- 1 Scroll to **Transformers ratio** and select current or voltage transformer ratio to be set.
- 2 Click “ENTER”.

The **Current / Voltage Transformer** screen appears

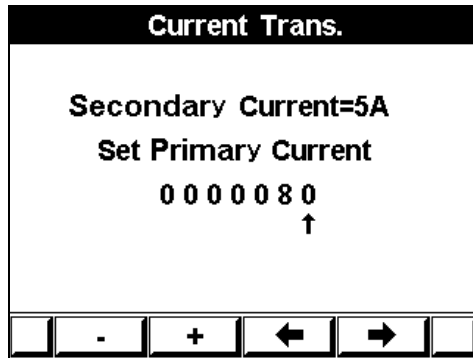
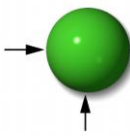

Figure 4.3 **Current Transformer**

The present setting for the **Current Transformer** is shown. Use the buttons F3 & F4 to move the cursor, to set the ratio use buttons F1 & F2.

The method for setting for the **Voltage Transformer** is the same.



4.2 — Change language

To change language on the display screen

1. From the **Main menu** screen click and hold the “F2” button for 6 second.

The **Set Language** screen appears



Figure 4.6 **Set Language**

2. To select the relevant language use buttons “F3” & “F4”, to set the language click on “Enter”.

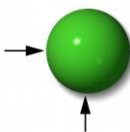

4.3 — Setting energy pulse out

The digital output (chapter 2.5) can be used as a pulse output, each pulse equivalent to pre define energy consumption value, in order to set the pulse output - See Section 4.0 for instructions to arrive at the **Technical Menu**.

From Technical Menu:

- 1 Scroll to **SET ENERGY PULSE**
- 2 Click "ENTER".
- 3 The **SET ENERGY PULSE** screen appears:

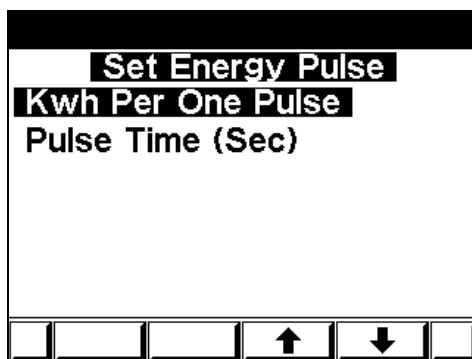
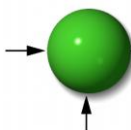

Figure 4.10 Set Energy Pulse

- 3 In order to set the KWH value pre pulse scroll to KWH Per One Pulse and click "ENTER".
- 4 In order to define how wide is the pulse scroll to Pulse Time and click "ENTER".
- 5 Please note that while you are using the output for energy pulse usage you cannot use the same output for alarms.



4.4 — Setting no-volt

The digital output (chapter 2.5) can be used as no-volt output, in case that the voltage value on one phase dropped below the defined value the out will open the contact.

See Section 4.1 for instructions to arrive at the **Technical Menu**.

From Technical Menu:

- 1 Scroll to **Min Voltage (D.Out)**.
- 2 Click “ENTER”.
- 3 The **Min Voltage (D.Out)** screen appears:

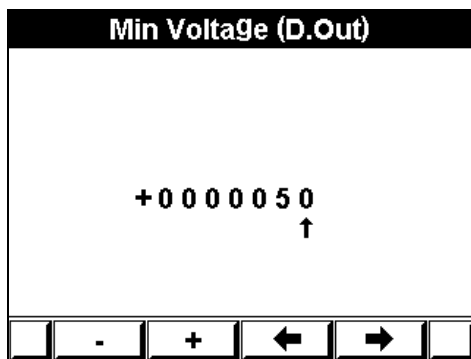
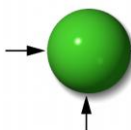

Figure 4.11 Set Min Voltage

- 4 The present setting for the **Min Voltage** is shown. Use the buttons F3 & F4 to move the cursor, to set the ratio use buttons F1 & F2.
- 5 Click “ENTER”.



4.5 — Setting cheack phase order

The digital output (chapter 2.5) can be used as phase order checks result, in case that have wrong wiring between phases the out pout will close the contact.

See Section 4.1 for instructions to arrive at the **Technical Menu**.

From Technical Menu:

- 1 Scroll to **Check Phase Order**.
- 2 Click “ENTER”.
- 3 The **Check Phase Order** screen appears:

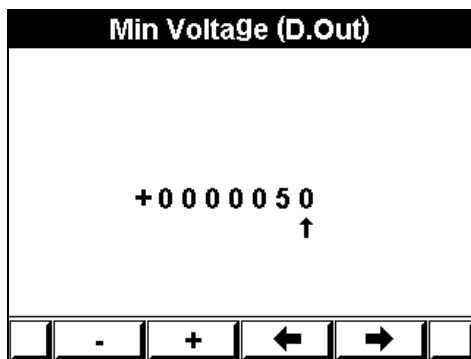

Figure 4.12 **Check Phase Order**

- 4 Use the buttons F3 & F4 to move the cursor, to set the ratio use buttons F1 &F2.
- 5 Click “ENTER”.

CHAPTER 5 — FRONT PANEL DISPLAYS

In this chapter you will find instructions on how to obtain the readings that the *ELNet LTE* Energy & Powermeter provides, e.g., Current, Voltage Power, Power Factor, Energy, and Power quality.

5.1 — Current Voltage & Frequency

To display Current Voltage and Frequency for all 3 Phases

- 1 From Main Menu scroll to Voltage, Current, Hz.

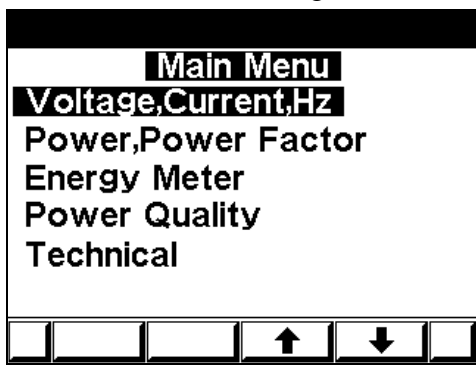

Figure 5.1 Main Menu

- 2 Click “ENTER”.

The Current Voltage and Frequency screen appears

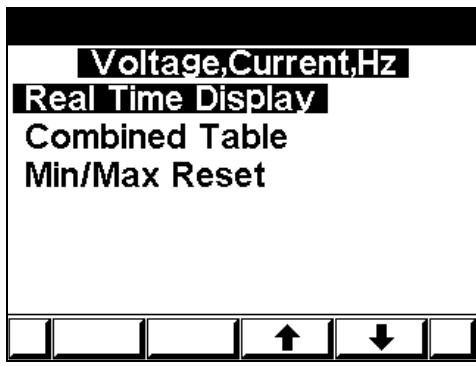
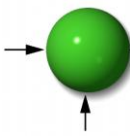

Figure 5.2 Voltage, Current, Hz



- 3 Scroll to REAL TIME DISPLAY and click “ENTER”

The **Current Voltage and Frequency** screen appears

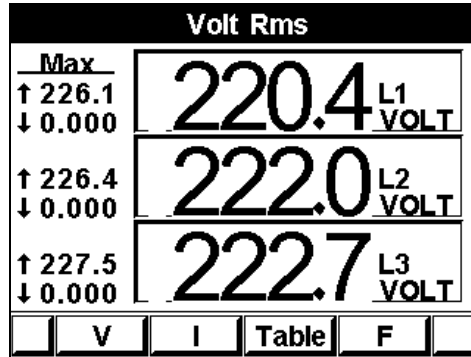
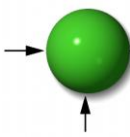

Figure 5.3 Voltage screen

- 4 Use “F1” in order to display voltage values.
- 5 Use “F2” in order to display current values.
- 6 Use “F3” in order to display Current and Voltage table view.
- 7 Use “F4” in order to display Frequency values.



5.2 — Reset I , V , F Peak values

In order to clear old peak values

- 1 From Main Menu scroll to Voltage, Current, Hz.
- 2 Click “ENTER” The **Current Voltage and Frequency** screen appears.
- 3 Scroll to **MIN/MAX RESET** and click “ENTER”.

The **Enter Code** screen appears

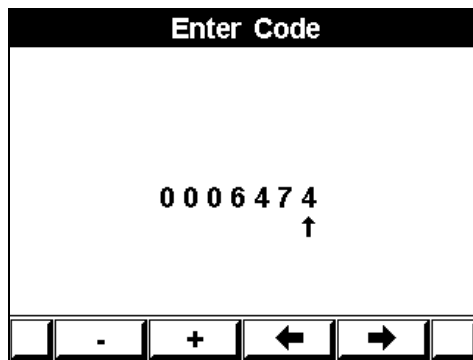

Figure 5.4 **Enter reset code**

In order to clear old peak values enter password 6474.

Use the buttons F3 & F4 to move the cursor, to set the value use buttons F1 & F2.

5.3 — Power Display

5.3.1 — Real time power display

To display Power for all 3 phases

- 1 From Main Menu scroll to **Power, power factor** Display.
- 2 The real time **Power, Power factor** screen appears

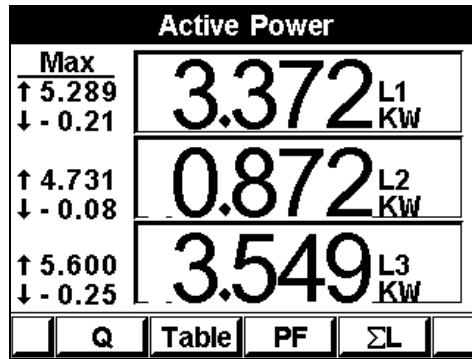
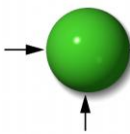

Figure 5.5 Power factor

- 4 Use “F1” in order to display Reactive Power values.
- 5 Use “F2” in order to display Power values table view.
- 6 Use “F3” in order to display Power Factor values.
- 7 Use “F4” in order to display total 3 lines active reactive and apparent power values.

Parameter	Description	Unit
P	Active Power for each Line	Watts
Q	Reactive Power for each Line	VAR
S	Apparent Power for each Line	VA
Σ P	Total Active Power for all 3 Lines	Watts
Σ Q	Total Reactive Power for all 3 Lines	VAR
Σ S	Total Apparent Power for all 3 Lines	VA
PF	Power Factor	

Table 5.1 Power Readings

5.4 — Power Quality

The *ELNet LTE* Energy & Powermeter is capable of displaying the Total Harmonic Distortion of Voltage and Current as well as the Current Real time demand.

- 1 From Main Menu scroll to **Power Quality**.
- 2 Click “ENTER”.

The **Current THD** screen appears

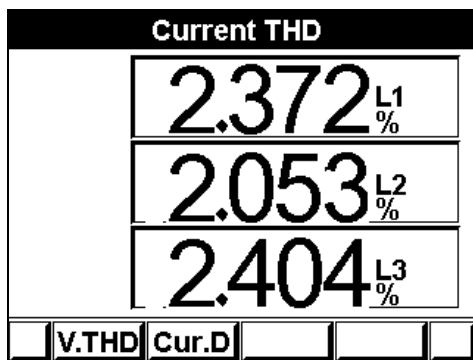

Figure 5.6 **Current THD**

- 3 Use “F1” in order to display Voltage THD values.
- 4 Use “F2” in order to display Current Real time demand values.

5.5 — Energy Metering

To display Active, Reactive or Apparent Energy values

- 1 From Main Menu scroll to **ENERGY METER**.
- 2 Click “ENTER”.

The Total **Energy** meter screen appears

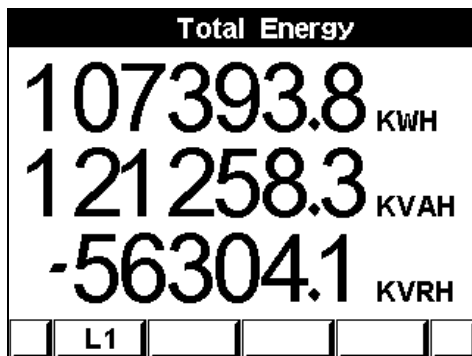

Figure 5.7 **Total Energy**

This meter will display the total energy that was measured and accumulated in the meter from the moment the meter was connected to the power. This meter is non erasable and the total energy that was measured and accumulated cannot be changed or deleted.

By using “F1” **The Elnet** will display the amount of the energy used for each line:

L1 = Line number 1

L2 = Line number 2

L3 = Line number 3

ALL= All Lines

CHAPTER 6 — COMMUNICATION

MODBUS Protocol

The ***ENet LTE*** Energy & Powermeter has a serial interface port allowing direct interface with an external communication network supporting the MODBUS Protocol.

MODBUS is an Industry Standard, widely known and commonly used communications protocol. Using MODBUS provides communication between a PC and up to 247 Powermeter slaves on a common line - the PC being the **master** and the powermeters the **slaves**. The PC initiates the transaction (either a query or broadcast) and the Powermeter/s responds. Powermeters respond to the **master** PC's request, but will not initiate any transmission on its own. The PC sends a single Query transaction and the Powermeter responds in a single response frame and is capable of only one query and one response at a time.

6.1 — MODBUS Framing

6.1.1— RTU Transmission Mode

MODBUS uses the standard Remote Terminal Unit (RTU) transmission mode. RTU mode sends data in 8-bit binary EVEN parity or 8-bit binary NO parity data format. For the ***ENet LTE*** Energy & Powermeter to successfully communicate, choose one in the communication Set Up.

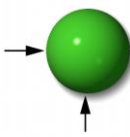

Field	No. of bits
Start bit	1
Data bits	8
Parity	1
Stop it	1

Table 6.1 **RTU Data Format**

6.1.2 — The RTU Frame Format

Query and response information is sent in frames. Each frame contains:

Address

Function (See Section 6.1.4 for descriptions of functions),

Data

Check

Address	Function	Data	Check
8 bits	8 bits	$N * 8$ bits	16 bits

Table 6.2 **RTU Message Frame Format**

If the receiving device (Powermeter) detects a time laps of five characters, then it will assume the message is incomplete and will flush the frame. The device then assumes that the next byte received will be an address. The maximum query and response message length is 256 bytes including check characters.

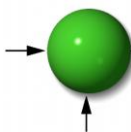

6.1.3 — Address Field

Each Powermeter is designated in a network system by a user assigned address. The Address can be any number between 1 and 247. The Powermeter will only respond to its own specifically assigned address.

6.1.4 — Function Field

The function field contains the code that tells the Powermeter what action to perform.

The ***EUNet LTE*** Energy & Powermeter uses and responds to four standard Message Format Functions.

Function 03

Function 04

Function 06

Function 16

Function	Meaning in MODBUS	Action
Function 03	Read holding register	Obtain data from Powermeter (Read register)
Function 04	Read input register	Obtain data from Powermeter (Read register)
Function 06	Preset single register	Transmit data to Powermeter (Write single register)
Function 16	Preset multiple register	Transmit data to Powermeter (Write multiple register)

Table 6.3 **Function Codes**

6.1.5 — Data Field

The Data field contains the body of the message and contains instructions from the PC **master** to the Powermeter **slave** to perform a particular action or respond to a query. The reply message from the Powermeter will be information contained in one or more of its registers.

6.1.6 — Check Field

The error check field contains the result of Cyclical Redundancy Check (CRC). The start of the message is ignored in calculating the CRC.

For more detailed information on CRC, refer to the MODBUS Protocol Reference Guide.

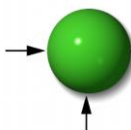

6.2 — Registers for EInet LTE Powermeter

The *EInet LTE* Energy & Powermeter is capable of supporting either Function 03 or Function 04 Message Format (see Table 6-3). In a reply to a query from the PC **master** for a reading from a particular field, the response from the Powermeter can be either in Format 03 or Format 04 but will depend on which Format the query was originally sent.

The difference is significant because by using Function 03 the EInet LTE will only send the INTERGER part of the field value requested and the PC **master** will only display the INTERGER part of the field value.

Function 04, on the other hand, is capable of sending two separate halves of the full FLOAT requested information (each half contained in a separate register). Then it is the task of the PC **master** to merge the two halves into a full FLOAT reply (For more detailed information See IEEE Standard 754 Floating-Point).

E.G. 1 If the user's PC **master** supports Function 03, then the reply will contain the INTERGER part of the field only.

The PC **master** requests the Voltage from Line1, and the actual Voltage in that field is 230.5 Volts.

Function 03 will respond with the INTERGER only i.e. 230V.

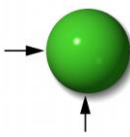

E.G. 2 If the user PC **master** supports Function 04, then the reply will contain the information stored in the two registers assigned to that field and will contain the full, accurate reply.

The PC master requests the Voltage from Line1, and the actual Voltage in that field is 230.5 Volts.

Function 04 will respond with a composite reply of both register 1 and 2 giving the full FLOAT value (in IEEE Format) from that field i.e. 230.5V.

6.2.1 — Registers addresses

The *ElNet LTE* MODBUS registers addresses are updated all the time and can be downloaded from the following web site: http://www.ddc.co.il/elnet-pdf/elnet_comm.pdf

The MODBUS registers addresses numbering order specify at the above mentioned web address set as a defaults but can be changed in order to be fit to the SCADA/HMI drivers.

6.3 — Communication Connections

The ElNet LTE Energy & Powermeter supports RS485 communication. Connections are provided on the Rear panel, (Please refer to section 2.3) and are made by means of the connectors provided.

6.4 — Communication Settings

To enable the *User* to connect the ***ELNet LTE*** Energy & Powermeter to a PC computer for successful communications, the Communication Setup parameters of both must match; i.e. the port of the PC and the configuration settings of the Power meter.

Address	Baud Rate	Parity
---------	-----------	--------

6.4.1 — Communication Address

Each Power meter in a communication system must have its own unique address.

Because the ***ELNet LTE*** Energy & Powermeter works on MODBUS, the available addresses are - from '1' to '247'

6.4.2 — Baud Rate

The Baud Rate is the communication speed in Bits per second (BPS) that the ***ELNet LTE*** Energy & Powermeter communicates with the PC. The better the communication line Quality, the faster the communications may be.

If the communication line is routed through a “noisy” environment, it may be necessary to decrease the Baud Rate.

Available Baud Rates for the ***ELNet LTE*** Powermeter:

300 bps	9600 bps
600 bps	19200 bps
1200 bps	38400 bps
2400 bps	57600 bps
4800 bps	115200 bps

6.4.3 — Parity

The choices of parity are either NONE or EVEN (see Section 6.1.1 for description of Parity)

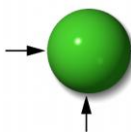

6.5 — Communication Set Up

6.5.1 — Set up Serial Communications

See Section 4.0 for instructions to reach the Technical Menu.

- 1 From Technical Menu scroll to **Set Communication**.
- 2 Click "ENTER".
- 3 Scroll to "**Serial Comm.**" and click "Enter".

The **Serial Communication Setup** screen appears

Set Communication	
ADDRESS	31
BAUDRATE	4800
PARITY	EVEN

- + ↑ ↓

Figure 6.2 **Serial Communication Setup**

Use buttons F1 & F2, to set the values

Use the buttons F3 & F4 to move the cursor

NOTE!

When the selection is made it takes immediate affect with no further action required.

6.6 — Communication with UniArt Software

CONTROL APPLICATIONS Ltd propriety software, “UniArt” is used to **Read** and **Write** Registers of the ***EINet LTE*** Energy Powermeter. Each Item number in the Registers Table is a unique field containing information. The UniArt software manages each Item number as a parameter.

Refer to the UniArt manual how to set up parameters.

To read fields using UniArt

- 1 Find the reading required in the MODBUS Registers Table
- 2 Note the Item Number from the Registers Table
- 3 Go to the correct File number

Since File capacity in UniArt is limited to 128 parameters, the information contained in the EINet LTE fields is stored in several files.

File number is determined by the Item number

File # 0 contains	Item number	1 - 128
File # 1 contains	Item number	129 – 256
File # 2 contains	Item number	257 – 384
File # 3 contains	Item number	385 – 512

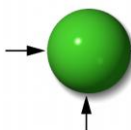

CHAPTER 7 — Specifications

Item	Description
Power requirements	90 - 250 VAC (optional) 110 - 280 VDC (optional) 60/50 Hz 9 VA
Dimensions	(HxWxD) 960x960x80 mm
Shipping Weight	450 gr.
Measuring current limits	6 A
Operating Voltage limits	1000 V
Operating Current limits	50 A
Enclosure material	ABS + Anti flame
Display	Graphic 320x240 color screen
Operating temperature	-20 - + 70 C
Storage temperature	-20 - + 80 C
Humidity	0- 90 RH%
Voltage input terminals	VL – E10 1708
Communication port	RS485
Mounting	Front Panel Mounting

Table 7.1 Specifications

All technical specifications are subject to change without notice.

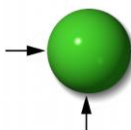

7.1 — Measurement & Display

Measurement & Display (scaling factor 1)

Measurement Parameter	Display Range in direct connection (scaling factor 1)	Measuring in direct connection (scaling factor 1)	Display Range
Current	0.001 – 6A	0.001 – 6A	0.001 – 99999KA
Neutral Current (calculated)	0.001 – 6A	0.001 – 6A	0.001 – 99999KA
Voltage L-N	0.000 – 550 V	0.000 – 550 V	0.001 – 99999KV
Voltage L-L	0.000 – 650 V	0.000 – 650 V	0.001 – 99999KV
Frequency (Hz)	45.001-65.001 Hz	45.001-65.001 Hz	45.001-65.001 Hz
Active power total\phase			0.000W – 99999MW
Reactive power total\phase			0.000VAR - 99999MVAR
Apparent power total\phase			0.000VA - 99999MVA
Power Factor (cap.\ind.)	-1.000 ÷ 1.000	-1.000 ÷ 1.000	-1.000 ÷ 1.000
Active Energy total\phase			0.001WH – 99999999MWH
Reactive Energy total\phase			0.001VARH - 99999999MVARH
Apparent Energy total\phase			0.001VAH - 99999999MVAH
Harmonic THD VI			0.000 – 100%

Table 7.2 Measurement & Display

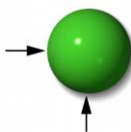

Index

Appendix A — Installation & Configuration Check List

INSTALLATION CHECK LIST

Description	Date	Signature
Check contents of packaging		
Remove from packaging		
Prepare hole		
Mount Powermeter		
Connect Powermeter power supply		
Connect 3 Current Transformers		
Connect 3 Voltage lines		
Connect Neutral line		
Set Current Transformer Ratio		
Connect Communication lines		
Check Phase Order Connections		

Appendix A Table - Installation & Configuration Check List