



proop

Professional Operator Panel

10.1" Operator Panel - Proop I 0

5" Operator Panel - ProopBlack5

7" Operator Panel - Proop7

4.3" Operator Panel - ProopBlack4



ARM Cortex-A Series



8GB eMMC



512 MB
DDR3 SDRAM

Datalogger and
Step Control Features
Recipe Definition
Multi-Language Editor

Internal Analogue / Digital Input and Output

7" Operator Panel - Proop7

- 4 Digital input
- 4 Digital output

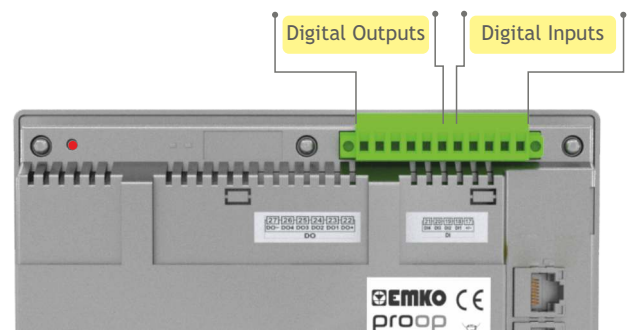

10.1" Operator Panel - Proop10

- 5 Digital input
- 4 Digital output
- 2 x 0/4...20 mA Analogue input
- 2 x 0/4...20 mA Analogue Output
- Optional Analogue input :
0...10 Vdc or 0...50 mV or PT-100
- Optional Analogue output :
0...10 Vdc

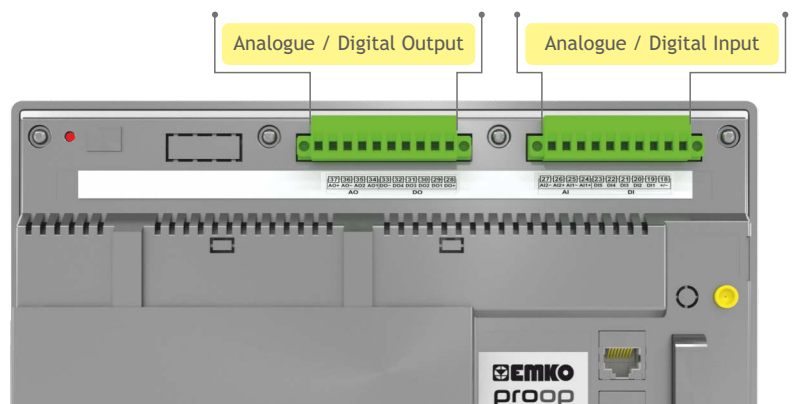

Macro:

Ensures processing of collected data and controlling internal input and outputs

C/C++ Ability to execute C codes in real time



COMPATIBLE with ERP/MES SYSTEMS

Full Compliance with ERP/MES production tracking applications

Macros and SQL client support for use in these applications

Mouse, keyboard, barcode reader, barcode printer, RFID reader connection via USB



IOT / MQTT SUPPORT

Supporting MQTT (V3.1, V3.1.1 ve V5.0) as standard communication protocol in IoT applications

Possibility to use cloud services such as Microsoft Azure, Google Cloud, Amazon AWS IoT



SMB File Sharing

Access to folders and files in the panel connected to the work over windows file explorer



Network



Video Player

Play MP4 video files over the panel



VNC

Remote Desktop feature



Communication Features

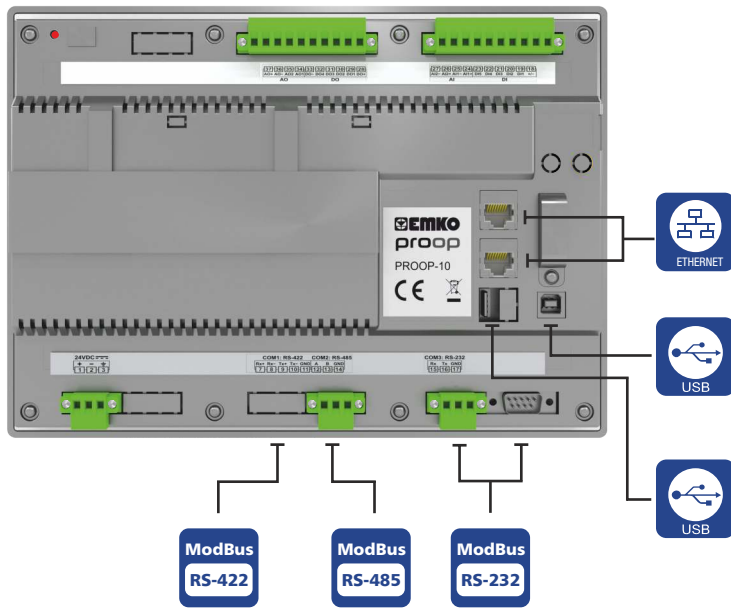

Internal

- IEEE 802.11 b/g/n standard
- 2.4 GHz frequency band
- Bitrate: max 72 Mbps
- WEP, WPA and WPA2 security protocols
- Soft-AP (access point) support
- Internal integrated antenna
- Certificates:
EN 61000-6-2 (EMC immunity)
EN 61000-6-4 (Radiated emissions)
EN 61010-1 (Safety standards)

Communication Protocols

MODBUS	Modbus-RTU
MODBUS	Modbus-ASCII
MODBUS	Modbus TCP/IP
MODBUS	Modbus-ASCII(Slave)
MODBUS	Modbus-RTU(Slave)
MODBUS	Modbus TCP/IP(Slave)
SIEMENS	S7-300(ISOTCP)
SIEMENS	S7-400(ISOTCP)
SIEMENS	S7-1200(ISOTCP)
SIEMENS	S7-1500(ISOTCP)
BACNET	MS/TP
BACNET	IP
OMRON	Host Link
OMRON	FINS
DELTA	DVP Series PLC

Project Download and Upload Via USB and Ethernet



USB Input (With USB cable connection) : Project Upload and Download

High speed data transfer with ethernet project upload, project download, VNC remote connection and SMB file sharing

USB Host Input (With Flash memory) : Upload

Project upload and data recording with USB 2.0

USB Host Input for Keypad, Mouse Connection

Barcode reader, Barcode Printer, RFID reader

Regional Formatting Format Support



Time, date and number formats can be set for local territories.

User can create his own font library.
 Microsoft Windows Font File Format (Windows FNT),
 TrueType (TTF), PostScript Type1 (PFA/PFB), Bitmap Distribution Format (BDF),
 CID-keyed Type1, Compact Font Format (CFF), OpenType fonts,
 SFNT-based bitmap fonts, Portable Compiled Format (PCF),
 Portable Font Resource (PFR), Type 42 (Limited support) supports font types.



Graphics / Visual Features



User can create his own picture library.
 Over 100 vector-based prefabricated elements.
 Vector based user defined image (SVG) support.
 BMP, GIF, JPG, JPEG, PNG, PBM, PGM, PPM, TIFF, XBM, XPM format picture support.
 Enhanced visual drawing infrastructure ; antialiasing, alphablending support.

Online / Offline Simulation Mode

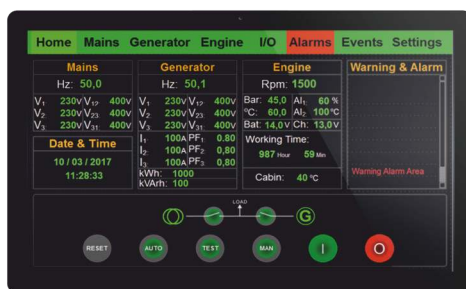

Online Simulation:
 The designed screen display, macro commands and PLC communication can be tested on the PC without being loaded on the Proop device.

Offline Simulation:
 Pre-screening of the designed screen can be done without loading on the compilation and Proop device.



Multi-language support,
Free Type and Windows Font support,
Defining user image library,
Simulation feature,

C / C ++ real-time programming,
BACNET MSTP,
MODBUS-RTU / -ASCII (Master / Slave) communication,
Compatible with OMRON Host Link, DELTA DVP Series PLCs.



ARM Cortex-A Series



8GB eMMC



512 MB
DDR3 SDRAM



50000 hours
Backlight Life

Technical Specifications

System

Communication Ports	1x RS-232 + 1x RS485 + 1x USB host + 1x USB device
Real Time Clock	Internal

Environmental Conditions

Protection Class	Ip65
Operating Tem. / Humidity	0...50°C / 0...90%RH
Storage Temperature	-20...60°C

Communication Ports

RS-232	Max. 230400 Baudrate
RS-485	Max. 115200 Baudrate

Display

LCD Backlight	Led
Touch Method	Resistive Analogue

Power

Operating Voltage	18...30Vdc
Power Consumption	5W (4.3", 5"), 6W (7")
RTC Battery / Life	Cr2032 button cell lithium bat. 3V / 5years



Professional Operator Panel

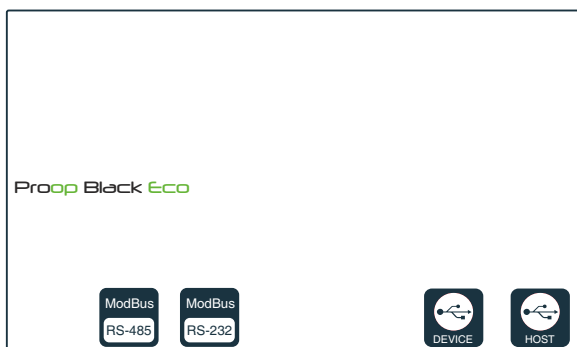

Optional Input / Output Expansion Module

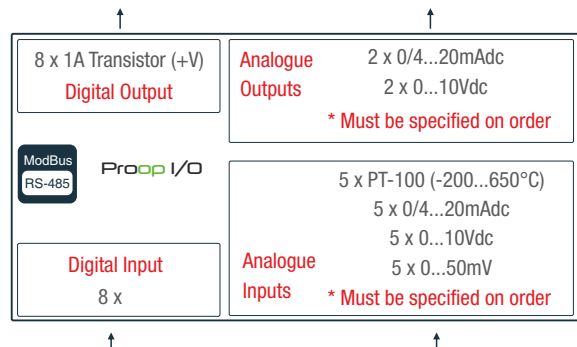

* 2 fast counters can be defined
* Maximum count frequency of a high-speed counter Maximum 10 kHz for encoder inputs, 15 kHz for counter inputs.

Product Codes

Proop Black Eco	Display Type	Display Colors	Display Resolution	Luminance (Cd/m2)	Device Dimensions	Panel Cut-Out	Weight
Proop.black-4.eco	4.3" TFT	260K colors	480x272	530	153x105x50mm	143x97mm	350gr
Proop.black-5.eco	5" TFT	260K colors	800x480	330	153x105x50mm	143x97mm	350gr
Proop.black-7.eco	7" TFT	260K colors	800x480	300	206x152x50mm	196x142mm	700gr

Proop Black Lite Series

Proop Black Lite



Proop Lite



10.1" TFT LCD
Touch screen

7" TFT LCD
Touch screen



7" TFT LCD
Touch screen

10.1" TFT LCD
Touch screen

Multi-language support, Free Type and Windows Font support,
Defining user image library,
Simulation feature,
MQTT communications protocol,
SQL client property,
VNC remote control feature,

SMB file sharing,
Video playback feature,
C / C ++ real-time programming,
BACNET MSTP, MODBUS-RTU / -ASCII (Master / Slave) communication,
Communication with SIEMENS, BACKNET IP, OMRON FINS, MODBUS TCP,
Compatible with OMRON Host Link, DELTA DVP Series PLCs.



ARM Cortex-A Series



8GB eMMC



512 MB
DDR3 SDRAM



50000 hours
Backlight Life



Professional Operator Panel



Optional
Input / Output Expansion Module

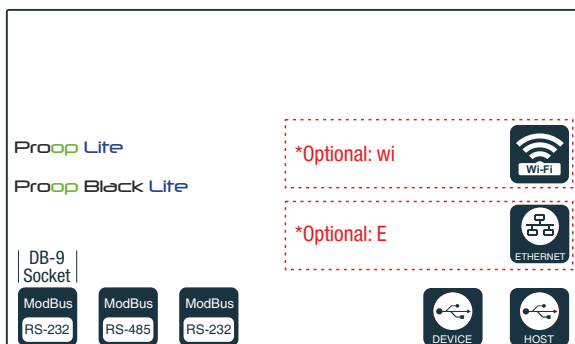

+

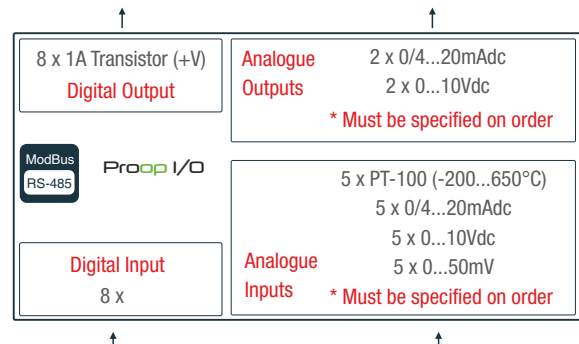

* 2 fast counters can be defined

* Maximum count frequency of a high-speed counter Maximum 10 kHz for encoder inputs, 15 kHz for counter inputs.

Technical Specifications

Dimensions

Device Dimensions	7" (206x152x50mm) , 10.1" (278x200x50mm)
Panel Cut-Out	7" (196x142mm) , 10.1" (265x186mm)
Weight	7" (700gr) , 10.1" (1300gr)

Environmental Conditions

Protection Class	Ip65
Operating Tem. / Humidity	0...50°C / 0...90%RH
Storage Temperature	-20...60°C

Communication Ports

RS-232	Max. 230400 Baudrate
RS-485	Max. 115200 Baudrate

Display

LCD Backlight	Led
Touch Method	Resistive Analogue

Power

Operating Voltage	18...30Vdc
Power Consumption	6W (7") , 8W (10.1")
RTC Battery / Life	Cr2032 button cell lithium bat. 3V / 5years

Product Codes



Proop Lite	Display Type	Display Colors	Display Resolution	Luminance (Cd/m2)	Ethernet (10/100 Mbps)	Wifi (IEEE 802.11b/g/n)
Proop-7L.wi	7" TFT	260K color	800x480	300		1x
Proop-7L.E	7" TFT	260K color	800x480	300	1x	
Proop-7L.Ewi	7" TFT	260K color	800x480	300	1x	1x
Proop-10L	10.1" TFT	16M color	1024x600	270		
Proop-10L.wi	10.1" TFT	16M color	1024x600	270		1x
Proop-10L.E	10.1" TFT	16M color	1024x600	270	1x	
Proop-10L.Ewi	10.1" TFT	16M color	1024x600	270	1x	1x

Product Codes



Proop Black Lite	Display Type	Display Colors	Display Resolution	Luminance (Cd/m2)	Ethernet (10/100 Mbps)	Wifi (IEEE 802.11b/g/n)
Proop.black-7L.wi	7" TFT	260K color	800x480	300		1x
Proop.black-7L.E	7" TFT	260K color	800x480	300	1x	
Proop.black-7L.Ewi	7" TFT	260K color	800x480	300	1x	1x
Proop.black-10L	10.1" TFT	16M color	1024x600	270		
Proop.black-10L.wi	10.1" TFT	16M color	1024x600	270		1x
Proop.black-10L.E	10.1" TFT	16M color	1024x600	270	1x	
Proop.black-10L.Ewi	10.1" TFT	16M color	1024x600	270	1x	1x

Proop Control Series

Proop Black Control



Proop Control



10.1" TFT LCD
Touch screen

7" TFT LCD
Touch screen



7" TFT LCD
Touch screen

10.1" TFT LCD
Touch screen

Multi-language support, Free Type and Windows Font support,
Defining user image library,
Simulation feature,
MQTT communications protocol,
SQL client property,
VNC remote control feature,

SMB file sharing,
Video playback feature,
C / C ++ real-time programming,
BACNET MSTP, MODBUS-RTU / -ASCII (Master / Slave) communication,
Communication with SIEMENS, BACKNET IP, OMRON FINS, MODBUS TCP,
Compatible with OMRON Host Link, DELTA DVP Series PLCs.



ARM Cortex-A Series



8GB eMMC



512 MB
DDR3 SDRAM



50000 hours
Backlight Life



Professional Operator Panel



Optional
Input / Output Expansion Module

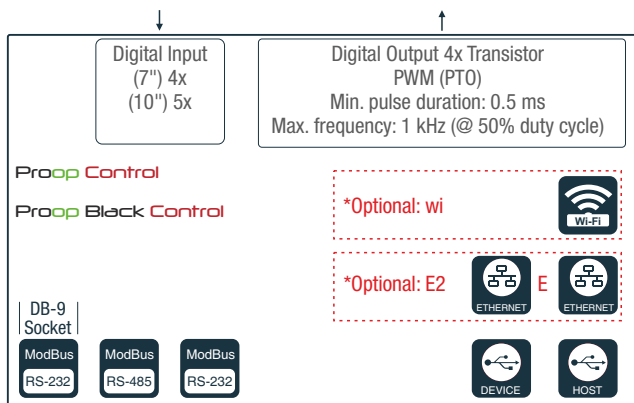

* Optical Isolated Digital Inputs and Outputs
* Digital Input and Output Sampling Period 50 ms.

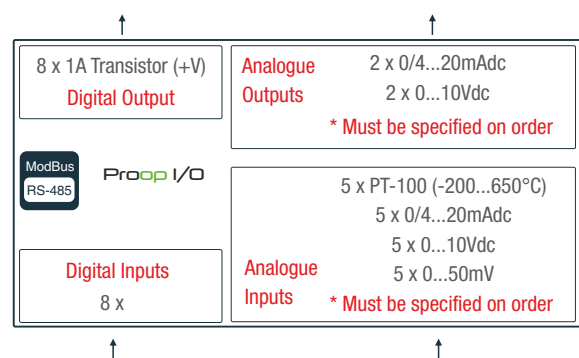

* 2 fast counters can be defined
* Maximum count frequency of a high-speed counter Maximum 10 kHz for encoder inputs, 15 kHz for counter inputs.

Technical Specifications

Dimensions

Device Dimensions	7" (206x152x50mm) , 10.1" (278x200x50mm)
Panel Cut-Out	7" (196x142mm) , 10.1" (265x186mm)
Weight	7" (700gr) , 10.1" (1300gr)

Environmental Conditions

Protection Class	Ip65
Operating Tem. / Humidity	0...50°C / 0...90%RH
Storage Temperature	-20...60°C

Communication Ports

RS-232	Max. 230400 Baudrate
RS-485	Max. 115200 Baudrate

Display

LCD Backlight	Led
Touch Method	Resistive Analogue

Power

Operating Voltage	18...30Vdc
Power Consumption	6W (7"), 8W (10.1")
RTC Battery / Life	Cr2032 button cell lithium bat. 3V / 5years

Product Codes



Proop Control	Display Type	Display Colors	Display Resolution	Luminance (Cd/m2)	Ethernet (10/100 Mbps)	Wifi (IEEE 802.11b/g/n)	Digital Inputs	Digital Outputs (Transistor)
Proop-7C	7" TFT	260K color	800x480	300			4x	4x
Proop-7C.wi	7" TFT	260K color	800x480	300		1x	4x	4x
Proop-7C.E	7" TFT	260K color	800x480	300	1x		4x	4x
Proop-7C.E2	7" TFT	260K color	800x480	300	2x		4x	4x
Proop-7C.Ewi	7" TFT	260K color	800x480	300	1x	1x	4x	4x
Proop-7C.E2wi	7" TFT	260K color	800x480	300	2x	1x	4x	4x
Proop-10C	10.1" TFT	16M color	1024x600	270			5x	4x
Proop-10C.wi	10.1" TFT	16M color	1024x600	270		1x	5x	4x
Proop-10C.E	10.1" TFT	16M color	1024x600	270	1x		5x	4x
Proop-10C.Ewi	10.1" TFT	16M color	1024x600	270	1x	1x	5x	4x

Product Codes



Proop Black Control	Display Type	Display Colors	Display Resolution	Luminance (Cd/m2)	Ethernet (10/100 Mbps)	Wifi (IEEE 802.11b/g/n)	Digital Inputs	Digital Outputs (Transistor)
Proop.black-7C	7" TFT	260K color	800x480	300			4x	4x
Proop.black-7C.wi	7" TFT	260K color	800x480	300		1x	4x	4x
Proop.black-7C.E	7" TFT	260K color	800x480	300	1x		4x	4x
Proop.black-7C.E2	7" TFT	260K color	800x480	300	2x		4x	4x
Proop.black-7C.Ewi	7" TFT	260K color	800x480	300	1x	1x	4x	4x
Proop.black-7C.E2wi	7" TFT	260K color	800x480	300	2x	1x	4x	4x
Proop.black-10C	10.1" TFT	16M color	1024x600	270			5x	4x
Proop.black-10C.wi	10.1" TFT	16M color	1024x600	270		1x	5x	4x
Proop.black-10C.E	10.1" TFT	16M color	1024x600	270	1x		5x	4x
Proop.black-10C.Ewi	10.1" TFT	16M color	1024x600	270	1x	1x	5x	4x

Proop Process

Proop Black Process



Proop Process



10.1" TFT LCD
Touch screen



10.1" TFT LCD
Touch screen

- Multi-language support, Free Type and Windows Font support,
- Defining user image library,
- Simulation feature,
- MQTT communications protocol,
- SQL client property,
- VNC remote control feature,

- SMB file sharing,
- Video playback feature,
- C / C++ real-time programming,
- BACNET MSTP, MODBUS-RTU / -ASCII (Master / Slave) communication,
- Communication with SIEMENS, BACKNET IP, OMRON FINS, MODBUS TCP,
- Compatible with OMRON Host Link, DELTA DVP Series PLCs.



ARM Cortex-A Series



8GB eMMC



512 MB
DDR3 SDRAM



50000 hours
Backlight Life



Professional Operator Panel



Optional
Input / Output Expansion Module

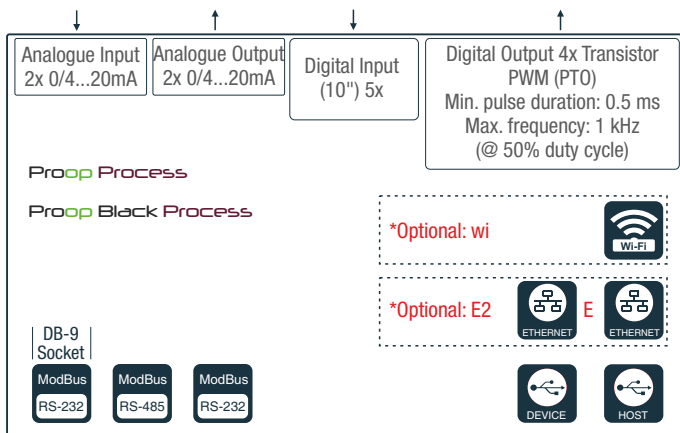

+

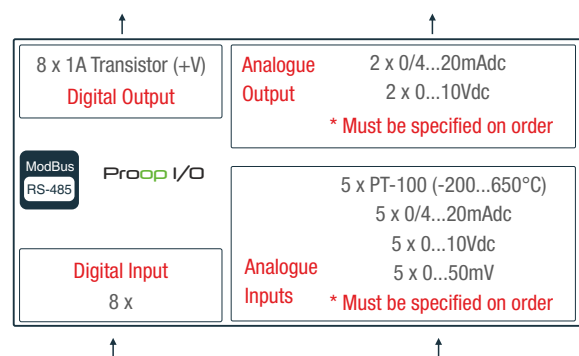

* Optical Isolated Digital Inputs and Outputs
* Digital Input and Output Sampling Period 50 ms
* Analog Input and Output Resolution 14 Bit Sampling Period 50 msec.

* 2 fast counters can be defined
* Maximum count frequency of a high-speed counter Maximum 10 kHz for encoder inputs, 15 kHz for counter inputs.

Technical Specifications

Dimensions

Device Dimensions	10.1" (278x200x50mm)
Panel Cut-Out	10.1" (265x186mm)
Weight	10.1" (1300gr)

Environmental Conditions

Protection Class	Ip65
Operating Tem. / Humidity	0...50°C / 0...90%RH
Storage Temperature	-20...60°C

Communication Ports

RS-232	Max. 230400 Baudrate
RS-485	Max. 115200 Baudrate

Display

Display Colors	16M Color
Display Resolution	1024x600
Luminance (Cd/m ²)	270
LCD Backlight	Led
Touch Method	Resistive Analogue

Power

Operating Voltage	18...30Vdc
Power Consumption	8W (10.1")
RTC Battery / Life	Cr2032 button cell lithium bat. 3V / 5years

Product Codes



Proop Process	Ethernet (10/100 Mbps)	Wifi (IEEE 802.11b/g/n)	Digital Inputs	Digital Outputs (Transistor)	Analogue Inputs	Analogue Outputs
Proop-10P.0.D5.D4.AC.AC			5x	4x	2x 4...20mA	2x 4...20mA
Proop-10P.wi.D5.D4.AC.AC		1x	5x	4x	2x 4...20mA	2x 4...20mA
Proop-10P.E.D5.D4.AC.AC	1x		5x	4x	2x 4...20mA	2x 4...20mA
Proop-10P.Ewi.D5.D4.AC.AC	1x	1x	5x	4x	2x 4...20mA	2x 4...20mA
Proop-10P.E2.D5.D4.AC.AC	2x		5x	4x	2x 4...20mA	2x 4...20mA
Proop-10P.E2wi.D5.D4.AC.AC	2x	1x	5x	4x	2x 4...20mA	2x 4...20mA

Product Codes



Proop Black Process	Ethernet (10/100 Mbps)	Wifi (IEEE 802.11b/g/n)	Digital Inputs	Digital Outputs (Transistor)	Analogue Inputs	Analogue Outputs
Proop.black -10P.0.D5.D4.AC.AC			5x	4x	2x 4...20mA	2x 4...20mA
Proop.black -10P.wi.D5.D4.AC.AC		1x	5x	4x	2x 4...20mA	2x 4...20mA
Proop.black -10P.E.D5.D4.AC.AC	1x		5x	4x	2x 4...20mA	2x 4...20mA
Proop.black -10P.Ewi.D5.D4.AC.AC	1x	1x	5x	4x	2x 4...20mA	2x 4...20mA
Proop.black -10P.E2.D5.D4.AC.AC	2x		5x	4x	2x 4...20mA	2x 4...20mA
Proop.black -10P.E2wi.D5.D4.AC.AC	2x	1x	5x	4x	2x 4...20mA	2x 4...20mA

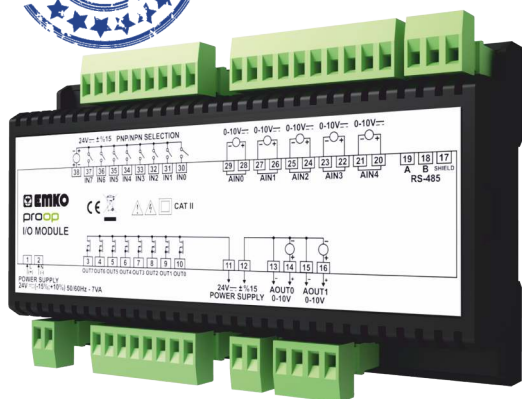

Proop-I/O

I/O Module Proop Rear Panel Mounting

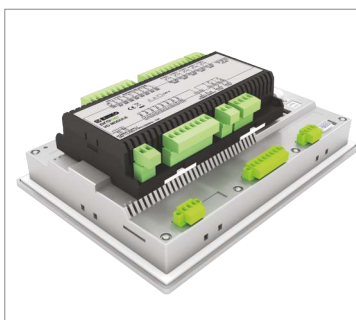

I/O Module Mounting on DIN-Rail

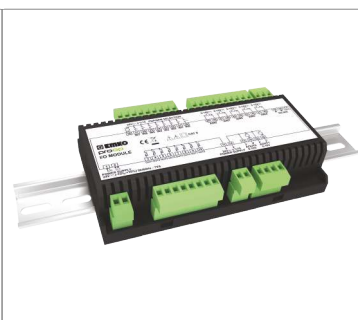

Technical Specifications

System Resources	
Communication Ports	1x RS485
Environmental Conditions	
Working Temperature	0...50°C
Humidity	0...90%RH
Supply	
Module Supply Voltage	24 Vdc/ac (Insulated)
Size / Weight	
Size	190 x 90 x 35mm
Weight	238gr
Communication Port	
RS-485	Max. 115200 Baudrate
Inputs / Outputs	
Digital	Sample Rate 50 msec.
Analogue	Sample Rate ~500 msec. Resolution 14 Bit

Proop-I/O	2	2	1	3	E	F
Module Supply Voltage	24Vdc/Vac (Insulated)					
24Vdc/Vac (Insulated)	2					
Communication	RS-485 (Insulated)					
RS-485 (Insulated)	2					
Digital Inputs	8x Digital					
8x Digital		1				
Digital Outputs	8x 1A Transistor (+V)					
8x 1A Transistor (+V)				3		
E Analogue Inputs	5x Pt-100 (-200...650°C)					
5x Pt-100 (-200...650°C)					1	
5x 0/4...20mAdc					2	
5x 0...10Vdc					3	
5x 0...50mV					4	
F Analogue Outputs	2x 0/4...20mAdc					
2x 0/4...20mAdc						1
2x 0...10Vdc						2

Product Codes

Proop-I/O	Digital Inputs	Digital Outputs	Analogue Inputs	Analogue Outputs
Proop-I/O.P.2.2.1.3.1.1	8x Digital	8x 1A Transistor (+V)	5x Pt-100 (-200...650°C)	2x 0/4...20mAdc
Proop-I/O.P.2.2.1.3.2.1	8x Digital	8x 1A Transistor (+V)	5x 0/4...20mAdc	2x 0/4...20mAdc
Proop-I/O.P.2.2.1.3.3.1	8x Digital	8x 1A Transistor (+V)	5x 0...10Vdc	2x 0/4...20mAdc
Proop-I/O.P.2.2.1.3.4.1	8x Digital	8x 1A Transistor (+V)	5x 0...50mV	2x 0/4...20mAdc
Proop-I/O.P.2.2.1.3.1.2	8x Digital	8x 1A Transistor (+V)	5x Pt-100 (-200...650°C)	2x 0...10Vdc
Proop-I/O.P.2.2.1.3.2.2	8x Digital	8x 1A Transistor (+V)	5x 0/4...20mAdc	2x 0...10Vdc
Proop-I/O.P.2.2.1.3.3.2	8x Digital	8x 1A Transistor (+V)	5x 0...10Vdc	2x 0...10Vdc
Proop-I/O.P.2.2.1.3.4.2	8x Digital	8x 1A Transistor (+V)	5x 0...50mV	2x 0...10Vdc



🏠: Bursa Organize Sanayi Bölgesi, (Fethiye OSB Mah.)
Ali Osman Sönmez Bulvarı, 2. Sokak, No:3 16215 Nilüfer - BURSA - TÜRKİYE
☎:+90 224 261 19 00 - 📠:+90 224 261 19 12
🌐:www.emkoelektronik.com.tr