

sanwa®



CD771

DIGITAL MULTIMETER

INSTRUCTION MANUAL **CE**

Table of Contents

[1] SAFETY PRECAUTIONS – Before use, read the following safety precautions.–	
1-1 Explanation of Warning Symbols	1
1-2 Warning Messages for Safe Use	1
1-3 Overload Protection	2
[2] APPLICATIONS AND FEATURES	
2-1 Applications	3
2-2 Features	3
[3] NAMES OF COMPONENT UNITS	
3-1 Meter	4
3-2 Test Leads	4
3-3 Display	5
[4] DESCRIPTION OF FUNCTIONS	
4-1 Power Switch & Function Switch	6
4-2 Measuring Function Selection	6
4-3 Data Hold	6
4-4 Backlight	6
4-5 Range Hold	7
4-6 Relative Measurement	7
4-7 Auto Power Off	7
4-8 Battery Low Warning Indication	7
[5] MEASURING PROCEDURE	
5-1 Start-up Inspection	8
5-2 Voltage Measurement (V)	9
5-3 Resistance Measurement (Ω), Diode Test (\rightarrow), Continuity Check (\bullet))	10
5-4 Frequency Measurement (Hz)	11
5-5 Capacitance Measurement ($\text{H}\leftarrow$)	12
5-6 Battery Load Voltage Measurement ($\text{d}1.5\text{V}$)	13
5-7 Current Measurement (μA / mA / A)	14
[6] MAINTENANCE	
6-1 Maintenance and Inspection	16
6-2 Calibration and Inspection	16
6-3 Storage	16
6-4 Battery and Fuse Replacement	16
[7] AFTER-SALE SERVICE	
7-1 Warranty and Provision	18
7-2 Repair	18
7-3 SANWA web site	19
[8] SPECIFICATIONS	
8-1 General Specifications	20
8-2 Measuring Range and Accuracy	21

[1] SAFETY PRECAUTIONS

***Before use, read the following safety precautions.**

This instruction manual explains how to use your new digital multi meter CD771. Before use, please read this manual thoroughly to ensure correct and safe use. After reading it, keep it together with the product for reference to it when necessary. Using this product in ways not specified in this manual may damage its protection function. The instructions given under the headings of “⚠ WARNING” and “⚠ CAUTION” must be followed to prevent accidental **burn** and **electric shock**.

1-1 Explanation of Warning Symbols

The meaning of the symbols used in this manual and attached to the product is as follows:

⚠: **Very important instructions for safe use.**

- The warning messages are intended to prevent accidents to operating personnel such as burn and electric shock.
- The caution messages are intended to prevent incorrect handling which may damage the product.

⚡ : High voltage hazard

⏏ : Ground

— : Direct current (DC)

Hz : Frequency

~ : Alternating current (AC)

⏚ : Capacitor

Ω : Resistance

1.5V : 1.5 V battery

➔ : Diode

☀ : Backlight

•)) : Buzzer

⏏ : Fuse

□ : Double insulation or reinforced insulation

1-2 Warning Messages for Safe Use

⚠ WARNING

The following instructions are intended to prevent personal injury such as burn and electric shock. Be sure to follow them when using the meter:

1. Never use the meter for power lines exceeding 6 kVA.
2. Voltages above 70VDC or 33Vrms AC (46.7V peak) are hazardous to human body. Take care so as not to touch them.
3. Never input signals exceeding the maximum rated input value (see 1-3).
4. Never use the meter for measuring voltages of lines connected to equipment (e.g. motors) that generates induced or surge voltage since it may exceed the maximum allowable overload input.

5. Never use the meter near equipment which generates strong electromagnetic waves or is charged.
6. Never use the meter if the meter or test leads are damaged or broken.
7. Never use the meter with the case or battery lid removed.
8. Be sure to use the fuse of the specified rating and specification.
9. During measurement, do not hold the test pin side of the flange of the test leads.
10. To start measurement, first connect the ground side (black test lead). When disconnecting, the ground side must be disconnected last.
11. During measurement, do not change the meter to another function or range nor replace the plugs to other terminals.
12. Before starting measurement, make sure that the function and range are properly set.
13. Never use the meter when it is wet or with wet hands.
14. Be sure to use the specified type of test leads.
15. Never attempt repair or modification, except for battery and fuse replacement.
16. Inspect the meter at least once a year.
17. This meter is for indoor use only.

⚠ CAUTION

1. Correct measurement may not be performed when using the meter in the ferromagnetic / intense electric field such as places near a transformer, a high-current circuit, and a radio.
2. The meter may malfunction or correct measurement may not be performed when measuring special waveform such as that of the inverter circuit.

1-3 Overload Protection

The maximum rated input value and overload protection have been established for the input terminals of each function.

Function	Input Terminal	Max. Rated Input Value	Max. Overload Protection Input Value
V · Hz	V/Hz/⚡ Ω/⚡/⦿) and COM	DC/AC1000V	DC/AC1000V
Ω / ⚡ / ⦿) · ⚡		⚠ Do not input a voltage or current.	
□1.5V	□1.5V μA and COM mA	DC2V	0.5A/1000V fuse Breaking capacity 30kA
μA		DC/AC4000μA ⚠ Do not input a voltage.	
mA		DC/AC400mA ⚠ Do not input a voltage.	
A	10A and COM	DC/AC10A ⚠ Do not input a voltage.	10A/1000V fuse Breaking capacity 30kA

[2] APPLICATIONS AND FEATURES

2-1 Applications

This is a digital multimeter designed for measurement in the ranges of CAT. II 1000V and CAT. III 600V. This meter is useful for measuring / analyzing circuits of small communication devices, home electric appliances and batteries within the CAT. III environment.

2-2 Features

- Safety design in compliance with the IEC61010-1. The current terminal is protected with a safety cap.
- Continuity confirmed by the buzzer and red LED lamp.
- Eye-friendly largesized display.
- Frequency measurement and capacitance measurement functions provided.
- Easy-to-hold design.
- Test probes can be secured to the body.
- Double molding with outside made of elastic elastomer material.

Classification of overvoltage measurement

Overvoltage measurement classification (CAT I):

Line on the secondary side on the inside of equipment via a transformer, etc. from the receptacle.

Overvoltage measurement classification (CAT II):

Line on the primary side of equipment with power cord to be connected to the receptacle.

Overvoltage measurement classification (CAT III):

Line from the primary side or branch of equipment which directly takes in electricity from a distribution board to the receptacle.

Overvoltage measurement classification (CAT IV):

Line from the service conductor to the distribution board.

[3] NAMES OF COMPONENT UNITS

3-1 Meter

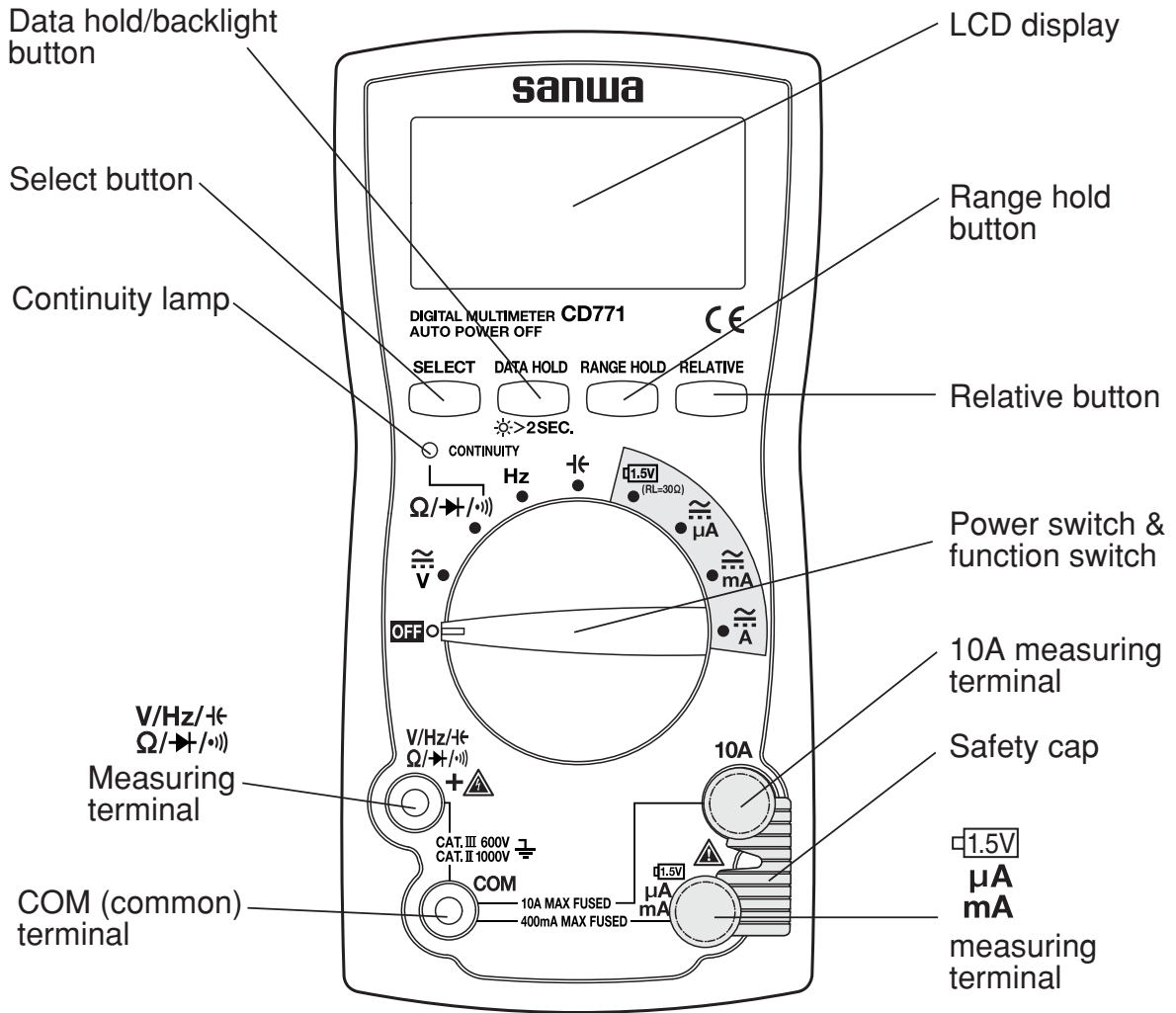

3-2 Test Leads

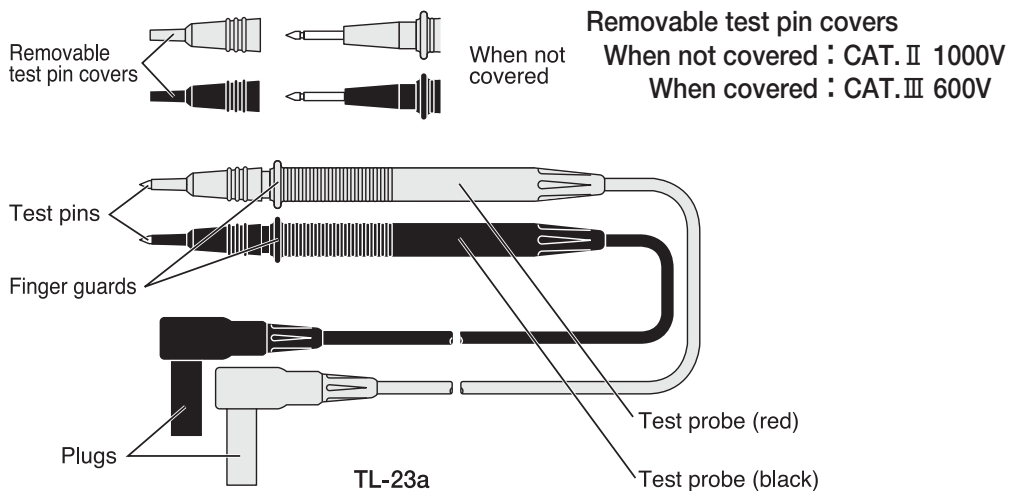

3-3 Display

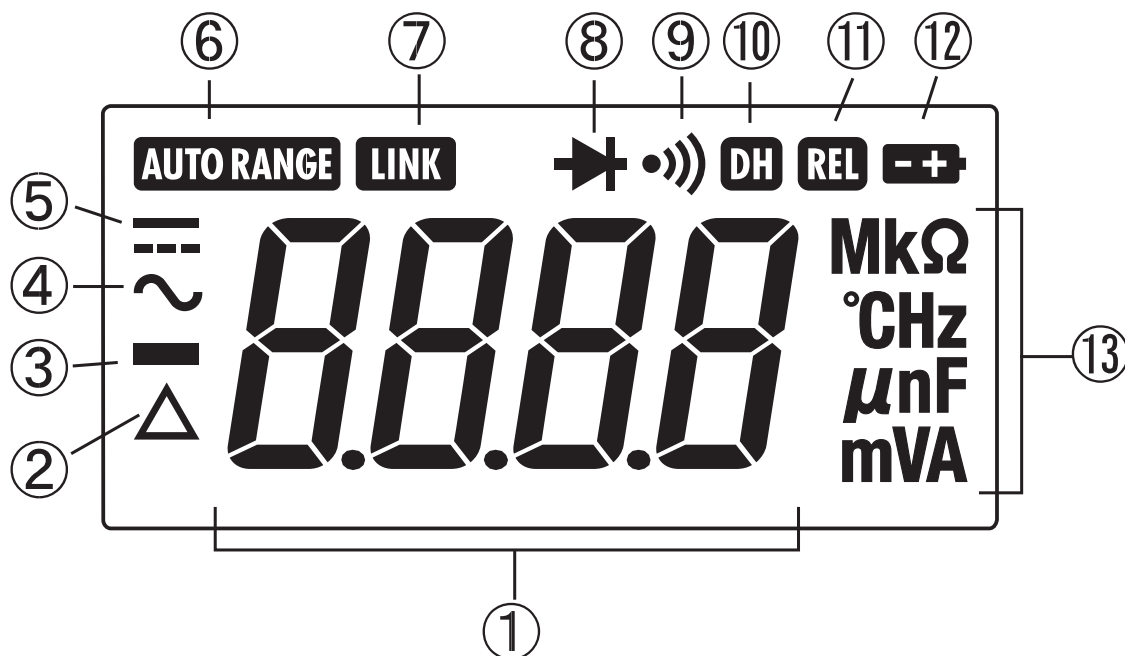

①	Indication of numerical value.
②	Indication of relative mode operation.
③	Indication of negative sign of numerical data.
④	Indication of AC measuring function operation.
⑤	Indication of DC measuring function operation.
⑥	Indication of auto range mode operation.
⑦	Not used with this meter.
⑧	Indication of diode test function operation.
⑨	Indication of continuity check function operation.
⑩	Indication of data hold mode operation.
⑪	Indication of relative mode operation.
⑫	Indication of battery low warning.
⑬	Indication of units of measurement.

















[4] DESCRIPTION OF FUNCTIONS

4-1 Power Switch & Function Switch

Turn this switch to turn on and off the power and select a measuring function.

4-2 Measuring Function Selection: SELECT

When the **SELECT** button is pressed, the functions change as follows:

- V position: DC voltage () → AC voltage () → DC voltage ()
- Ω /  /  position: Resistance measurement (Ω) → diode test () → continuity check () → resistance measurement (Ω)
- μ A position: DC current () → AC current () → DC current ()
- mA position: DC current () → AC current () → DC current ()
- A position: DC current () → AC current () → DC current ()

4-3 Data Hold: DATA HOLD

When the **DATA HOLD** button is pressed, the value indicated will be held. (“**DH**” will appear on the display.) The indicated value will not change if the measurement input fluctuates.

When this button is pressed again, the hold status will be canceled and the meter will return to the measurement mode. (“**DH**” will disappear from the display.)

Remarks:

- The **DATA HOLD** button does not work with the Hz function.

4-4 Backlight:

When the () button is held pressed for 2 seconds or longer, the backlight will be turned on. To turn it off, hold this button pressed for 2 seconds or longer again.

Remarks:

- Because the () button serves as the **DATA HOLD** button also, when the backlight is turned on, the data hold mode will be set. To cancel the data hold mode, press this button momentarily (less than 2 seconds) again.

4-5 Range Hold: RANGE HOLD

When the **RANGE HOLD** button is pressed, the meter will be set in the manual mode and the range will be fixed. (“**AUTORANGE**” will disappear from the display.) In the manual mode, each time this button is pressed, the range changes. While checking the unit and decimal point on the display, select the best range.

To return to the auto range, hold this button pressed for 1 second or longer. (“**AUTORANGE**” will appear on the display.)

Remarks:

- The RANGE HOLD button does not work with the (Hz), (→), (•) and (←) functions.

4-6 Relative Measurement: RELATIVE

When the **RELATIVE** button is pressed, **REL** and Δ will light and the input value when the button was pressed will become 0 as the reference. To cancel it, press the button again.

Example: Display after pressing the button at DC30.00V input

Actual Input Value	Value in Display
DC 30.00V	DC 00.00V
DC 35.00V	DC 05.00V
DC 25.00V	DC -05.00V

Remarks:

- This mode cannot be used with the **Hz** function. When a function other than (←) is used, the range is fixed during relative measurement.

4-7 Auto Power Off

If no switch or button is operated for about 30 minutes after power on, the power will automatically be turned off and the display will become blank.

To reset the meter, press any button or remove the object to measure from the DMM and set the function switch to OFF. Set the function switch again according to the measurement and connect the object to measure.

To cancel this function, turn on the power of meter while holding the **SELECT** button pressed.

4-8 Battery Low Warning Indication

When the built-in batteries have been discharged and the voltage has dropped to below about 2.4 V, “**+**” mark will appear in the display. When this mark flickers or lights, replace both two batteries with new ones.

[5] MEASURING PROCEDURE

⚠ WARNING

1. Do not apply an input signal exceeding the maximum rated input of each function.
2. During measurement, do not change the function switch.
3. During measurement, do not touch the test pin side of the flange of the test lead.
4. When measurement has been finished, remove the test pins from the object measured and return the function switch to the **OFF** position.

5-1 Start-up Inspection

⚠ CAUTION

1. Be sure that the battery low warning mark is not flickering or lit, when the meter is turned on. If it is flickering or lit, replace the batteries with new ones.
2. Do not use the meter if the meter or test lead is damaged or broken.
3. Make sure the test leads are not cut and the fuse has not blown.

Always conduct the start-up inspection to ensure safety. (Inspection by the continuity check.)

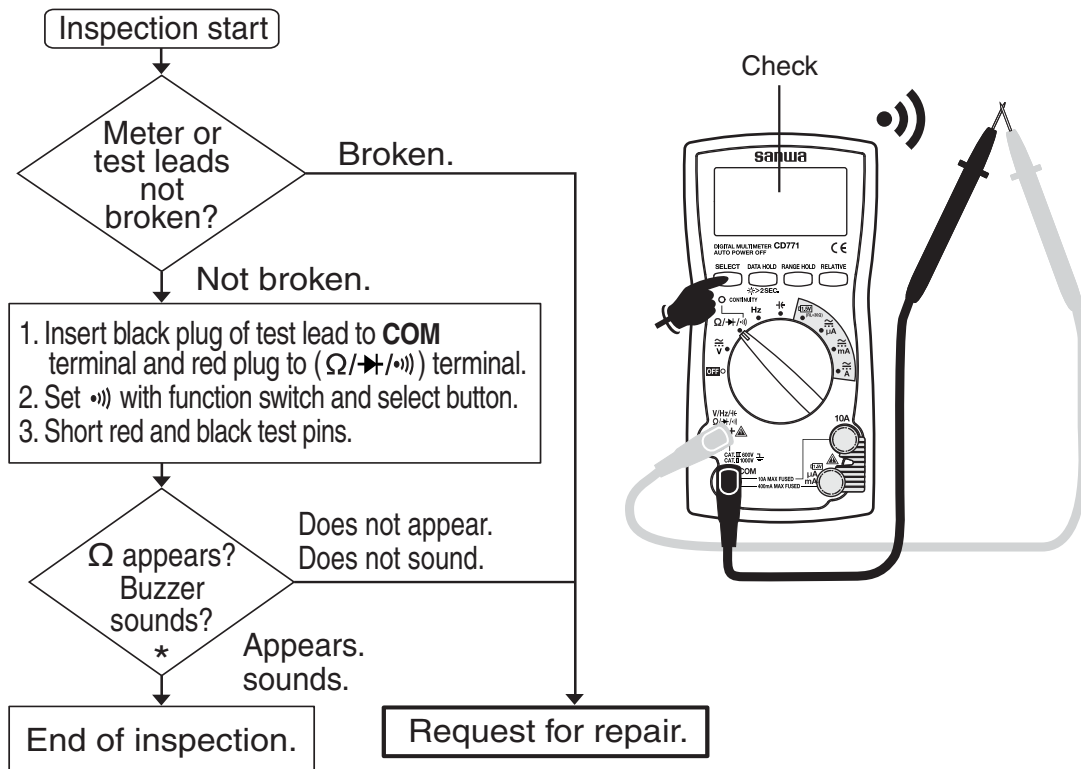

* If nothing appears on the display, the batteries might have been discharged completely.

5-2 Voltage Measurement (V)

Function	Max. Rated Input	Range
DCV	DC 1000V	400.0mV, 4.000V, 40.00V, 400.0V, 1000V
ACV	AC 1000V	4.000V, 40.00V, 400.0V, 1000V

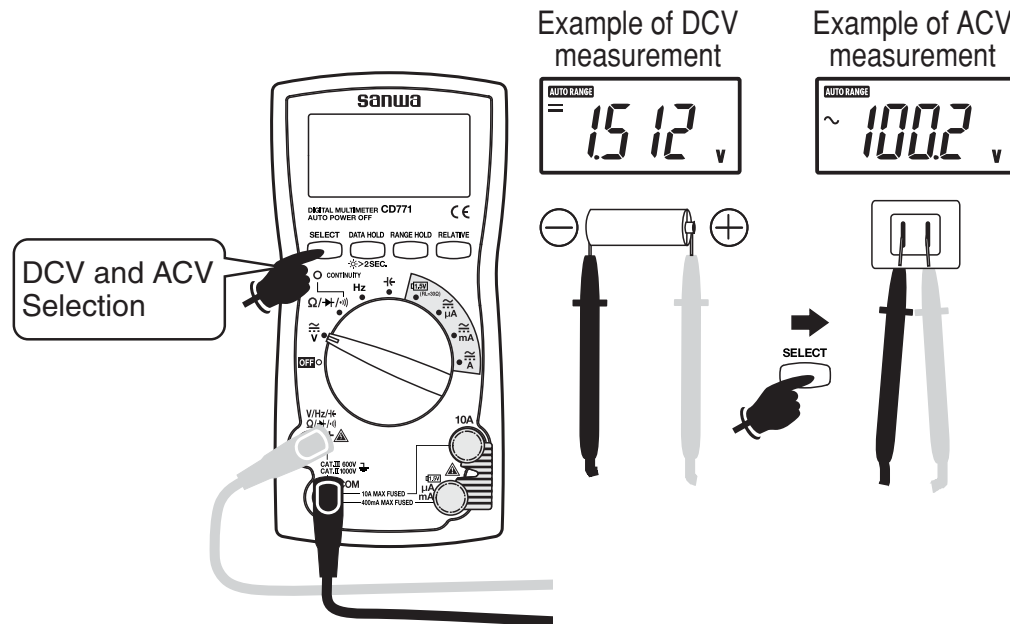

Remarks:

This meter's AC detection method is the average value method. It indicates an average value of voltage or current in the positive half cycle. No error will occur in measurement of waveforms when the input waveform is sinusoidal wave with no distortion. However, if the input waveform is distorted sinusoidal wave or non-sinusoidal wave, an error will occur.

- The indication may fluctuate when the test leads are released. It is not a failure.
- The AC400.0mV range can be selected with the RANGE HOLD button, but the accuracy is not guaranteed.
- In the AC4.000V range, when the measuring terminals are shorted, 7 counts maximum may remain indicated.
- The accuracy guarantee frequency range of ACV measurement is 40 Hz to 400 Hz.
If the frequency is above 1 kHz, measurement is not possible.
- It may malfunction when measuring voltage in the inverter circuit.

5-3 Resistance Measurement (Ω), Diode Test (\rightarrow), Continuity Check (\bullet)

⚠ WARNING
Never apply a voltage to the measuring terminals.

5-3-1 Resistance measurement (Ω)

Function	Max. Rated Input	Range
Ω	40.00M Ω	400.0 Ω , 4.000k Ω , 40.00k Ω , 400.0k Ω , 4.000M Ω , 40.00M Ω

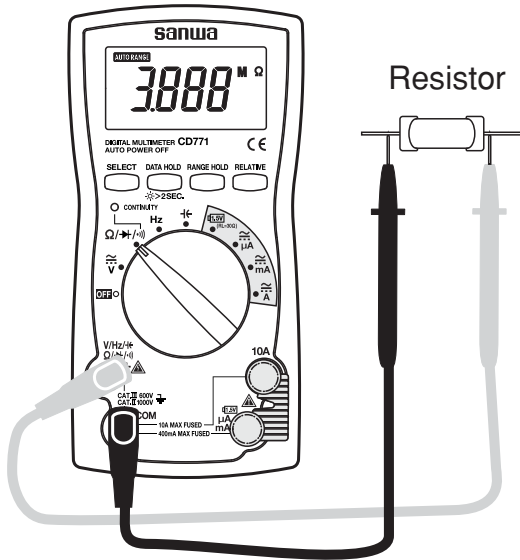

Remarks:

If measurement is affected by noises, shield the object to measure with COM potential. If measurement is conducted with a finger touching the test pins, an error will occur due to influence of resistance of the human body. The open voltage between the measuring terminals is approx. 0.4 VDC.

5-3-2 Diode test (\rightarrow)

Resistance measurement
Diode test
Continuity check
Selection

Remarks:

The open voltage between the measuring terminals is approx. 1.5VDC.

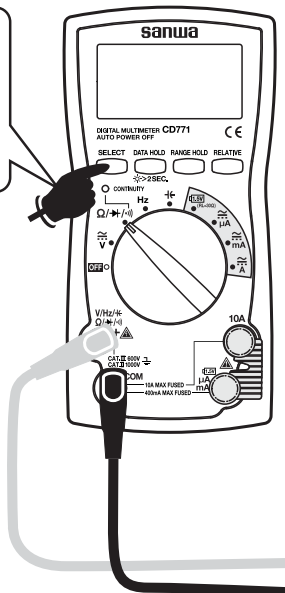

Forward direction test

0.556 v

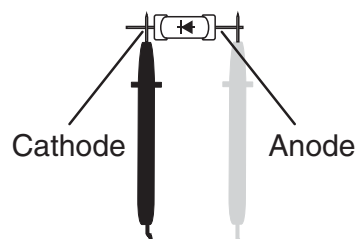

Good: Forward voltage drop shown
Bad: 0.000V shown
OL shown

Reverse direction test

OL v



Good: OL shown
Bad: Other indication

5-3-3 Continuity check (•)))

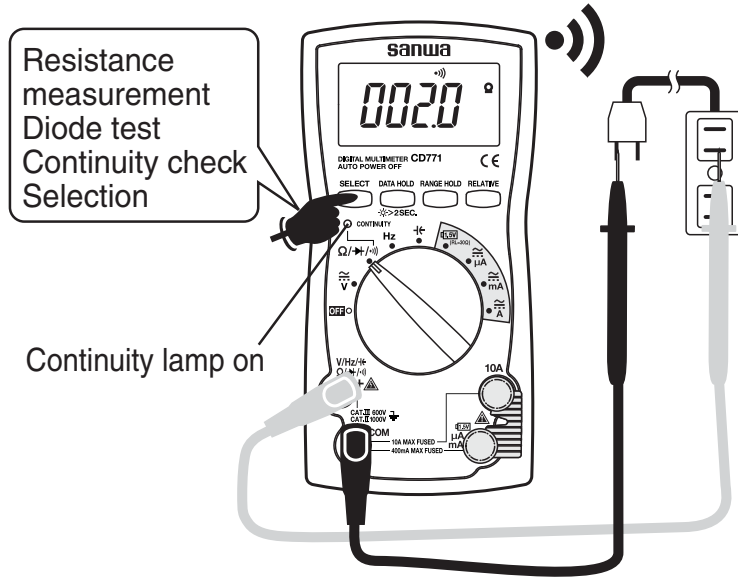

Remarks:

- Continuity buzzer sound and continuity lamp on range: $0 \Omega \sim 85 \Omega (\pm 45 \Omega)$

5-4 Frequency Measurement (Hz)

⚠ CAUTION

Never use the meter for measuring frequencies to ground as the earth leakage breaker may trip.

Measurement prohibited

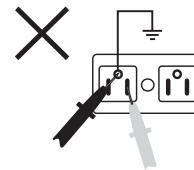

Function	Max. Rated Input	Range
Hz	100.0kHz ($\leq 1000V_{rms}$)	5.000Hz, 50.00Hz, 500.0Hz, 5.000kHz, 50.00kHz, 100.0kHz (Auto range only)

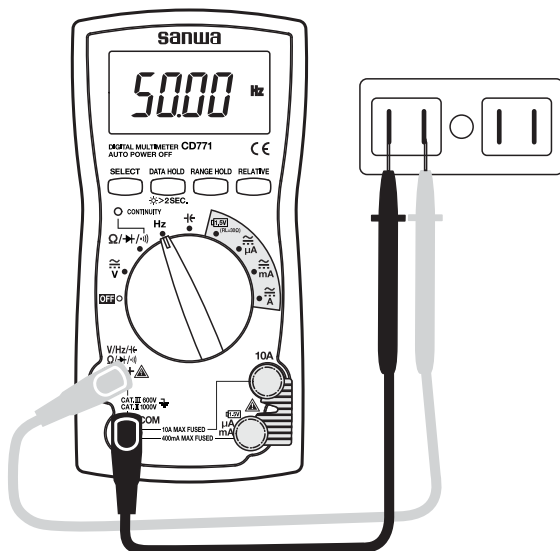

Remarks:

- Because the Hz function uses input resistance as low as approx. $2 \text{ k}\Omega$, a large amount of current will flow during measurement. Never use the meter for measuring circuits or devices having a small current capacity.

Remarks:

- Input sensitivity: 3 Vrms or over
- Zero cross (+ potential → - potential → + potential) frequencies can be measured. Frequencies of + potential only or - potential only such as logic pulses cannot be measured.
- Frequencies less than 1 Hz cannot be measured.
- When the Hz function is used, the data hold and relative function cannot be used.

5-5 Capacitance Measurement ($\overleftarrow{\leftarrow}$)

⚠ WARNING

Never apply a voltage to the measuring terminals.

⚠ CAUTION

1. Remove electric charge in the capacitor prior to measurement.
2. Because this meter applies a current to the capacitor to measure, it is not suitable for measurement of electrolytic capacitors having a large leak current as a large error will occur.
3. For capacitors having large capacitance, measurement takes a longer time.

Function	Max. Rated Input	Range
CAP($\overleftarrow{\leftarrow}$)	100.0 μ F	50.00nF, 500.0nF, 5.000 μ F, 50.00 μ F, 100.0 μ F (Auto range)

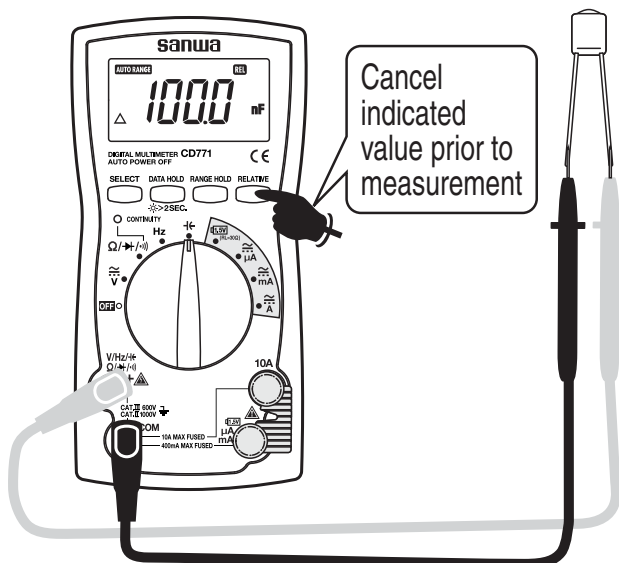

Remarks:

- For capacitance measurement, press the **RELATIVE** button to cancel the indicated value (00.00nF) before connecting a capacitor.
- Only the auto range is available for the capacitance measuring function.
- The indication may not become stable due to influence of surrounding noises or stray capacitance of the test leads.

5-6 Battery Load Voltage Measurement ($\square 1.5V$)

CAUTION

1. Never apply a voltage above the battery voltage (approx. 1.5 V) to the input terminals.
2. If measurement takes a long time, the battery being measured will be discharged. Complete measurement quickly.

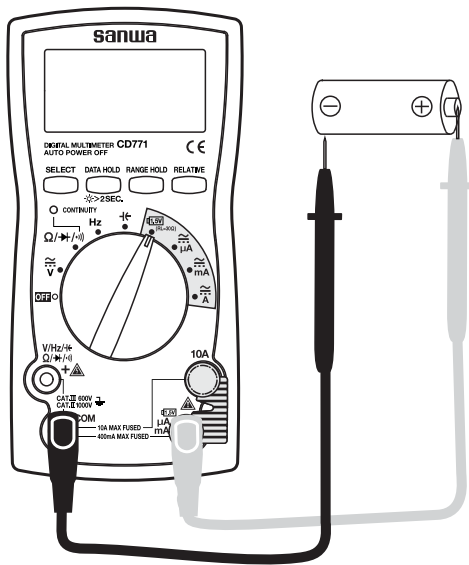

Function	Input Terminal	Built-in Fuse
$\square 1.5V$	$\square 1.5V$ and COM	0.5A/1000V Fuse Breaking capacity 30kA

Remarks:

- The battery load voltage measuring function is special for measurement of 1.5 V battery voltage.
- The measured value is the battery voltage when a load of $30\ \Omega$ is connected to the battery to measure.

Measurable batteries:

Manganese battery (R20, R14, R6)

Alkaline battery (LR20, LR14, LR6), etc.

5-7 Current Measurement (μA / mA / A)

⚠ WARNING

1. Never apply a voltage to the measuring terminals.
2. Never apply an input exceeding the maximum rated current.
3. Be sure to connect the meter in series via a load.

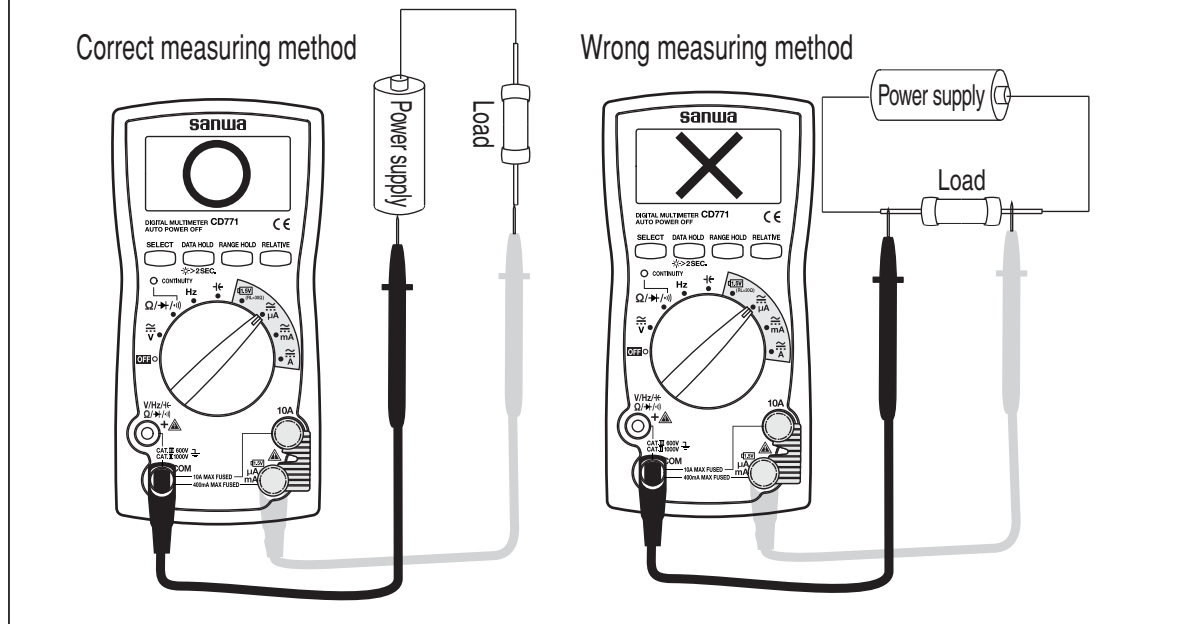

⚠ CAUTION

Be sure that the built-in fuse has not blown.

Function	Max. Rated Input	Range
DC/AC μA	4000 μA	400.0 μA , 4000 μA
DC/AC mA	400 mA	40.00 mA , 400.0 mA
DC/AC A	10 A	4.000 A , 10.00 A

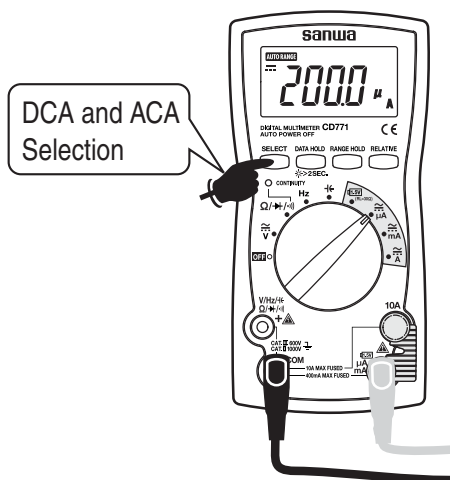

Remarks:

- In current measurement, the internal resistance of the current range is placed in series and the current drops by this resistance. Accordingly, its influence becomes larger in low-resistance circuits.
- The AC accuracy guarantee frequency range is from 40 Hz to 400 Hz.
- Current range: Auto range for 400.0 μA ~ 4000 μA , 40.00 mA ~ 400.0 mA and 4.000 A ~ 10.000 A . The range may be fixed by the RANGE HOLD button.

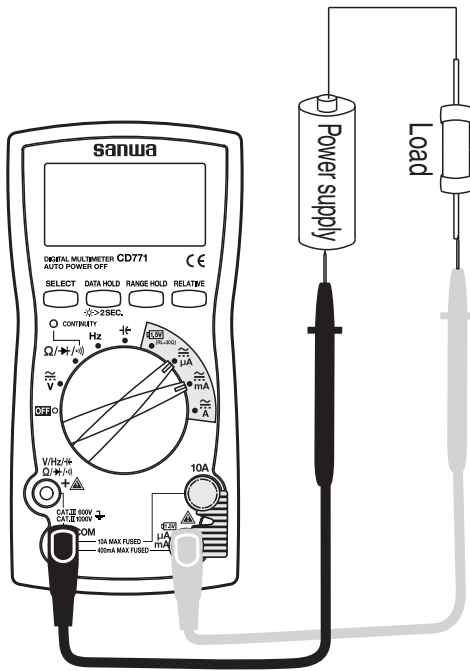

µA · mA measurement

Function	Input Terminal	Built-in Fuse
µA	µA and COM	0.5A/1000V Fuse Breaking capacity 30kA
mA		

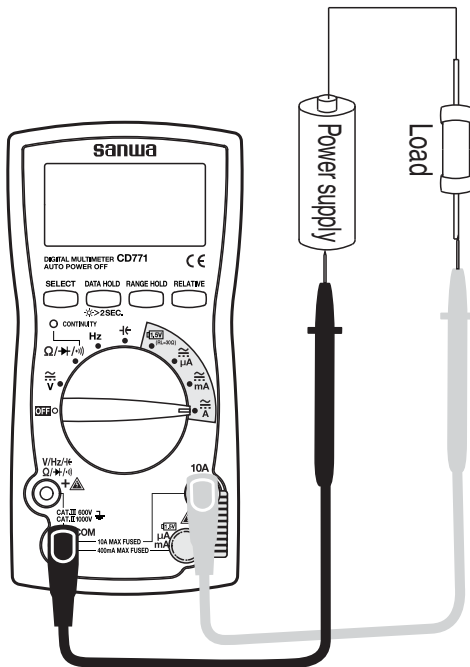

A measurement

Function	Input Terminal	Built-in Fuse
A	10A and COM	10A/1000V Fuse Breaking capacity 30kA

Remarks:

- Maximum 20A can be measured if the measurement time is less than 10 seconds.
(Take 10minutes or longer intervals between measurements.)

- If the indication will change little when an input signal is applied or a current value which is significantly smaller than the expected value is indicated, possible causes are the input terminals, incorrect setting of the function switch, or blown fuse. Check these places.

[6] MAINTENANCE

WARNING

1. The following instructions are very important for safety.
Read this manual thoroughly to ensure correct maintenance.
2. Calibrate and inspect the meter at least once a year to ensure safety and maintain its accuracy.

6-1 Maintenance and Inspection

- 1) Appearance: Is the meter not damaged due to falling or other cause?
- 2) Test leads:
 - Are the core wires not exposed from the test leads?
 - Is the plug when inserted to the input terminal not loose?If any of the above problems exists, stop using the meter and request for repair.

6-2 Calibration and Inspection

For more information, please contact Sanwa's authorized agent / distribute service provider, listed in our website.
See section 7-3.

6-3 Storage

CAUTION

1. The panel and case are not resistant to volatile solvent and must not be cleaned with thinner or alcohol.
2. The panel and case are not resistant to heat. Do not place the meter near heat-generating devices.
3. Do not store the meter in a place where it may be subjected to vibration or where it may fall.
4. Do not store the meter in places under direct sunlight, or hot, cold or humid places or places where condensation is anticipated.
5. If the meter will not be used for a long time, remove the batteries.

6-4 Battery and Fuse Replacement

Batteries when the meter is shipped:

A battery for monitoring has been installed prior to shipment from the factory. It may be discharged before the expiration of the described battery life.

*The battery for monitoring is a battery used to check the functions and performance of the product.

⚠ WARNING

1. To avoid electric shock, do not remove the rear case with an input being applied to the measuring terminals. Also, before starting replacement, make sure the power of the meter is OFF.
2. Be sure to use the replacement fuse of the same rating. Never use a substitute for the fuse nor short the meter.

6-4-1 Battery replacement

- ① Remove the fixing screw of the battery holder with a screwdriver.
- ② Replace both two batteries in the battery holder with new ones.
(Pay attention to their polarity.)
- ③ Set and secure the battery holder with the fixing screw as before.

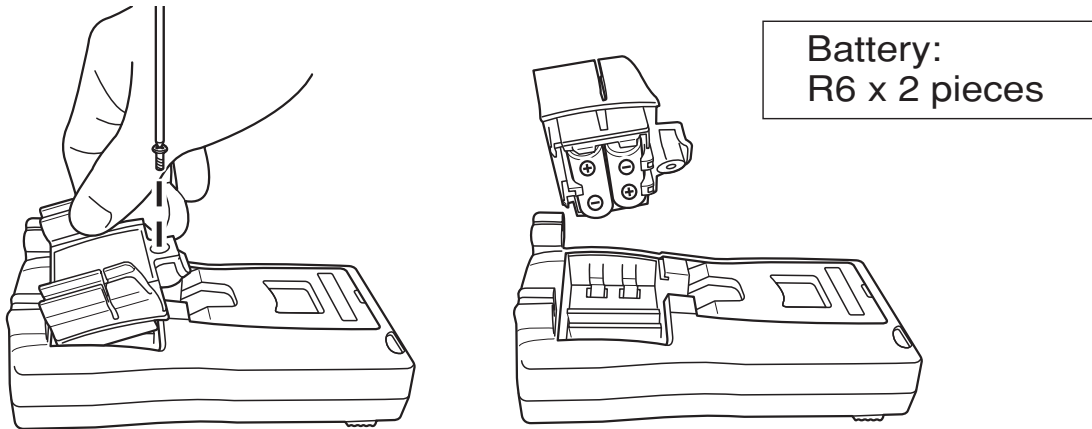

6-4-2 Fuse replacement

- ① Remove the screws of the body rear case with a screwdriver.
- ② Take out the fuse and replace it with a new one.
- ③ Secure the rear case with the screws as before.

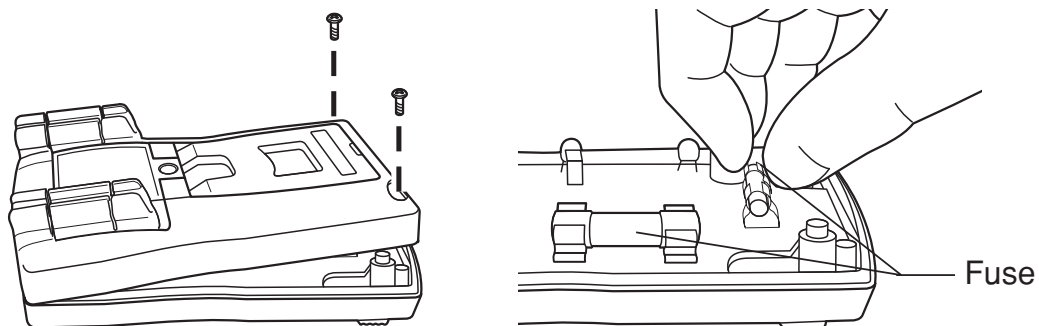

Fuse rating:

0.5A/1000V (ø6.35 x 32 mm, Breaking capacity 30kA)

10A/1000V (ø10 x 38 mm, Breaking capacity 30kA)

* Spare fuse storage is provided at the bottom of the rear case. (For ø6.35 x 32 mm fuse only)

[7] AFTER-SALE SERVICE

7-1 Warranty and Provision

Sanwa offers comprehensive warranty services to its end-users and to its product resellers. Under Sanwa's general warranty policy, each instrument is warranted to be free from defects in workmanship or material under normal use for the period of one (1) year from the date of purchase.

This warranty policy is valid within the country of purchase only, and applied only to the product purchased from Sanwa authorized agent or distributor.

Sanwa reserves the right to inspect all warranty claims to determine the extent to which the warranty policy shall apply. This warranty shall not apply to disposables batteries, or any product or parts, which have been subject to one of the following causes:

1. A failure due to improper handling or use that deviates from the instruction manual.
2. A failure due to inadequate repair or modification by people other than Sanwa service personnel.
3. A failure due to causes not attributable to this product such as fire, flood and other natural disaster.
4. Non-operation due to a discharged battery.
5. A failure or damage due to transportation, relocation or dropping after the purchase.

7-2 Repair

Customers are asked to provide the following information when requesting services:

1. Customer name, address, and contact information
2. Description of problem
3. Description of product configuration
4. Model Number
5. Product Serial Number
6. Proof of Date-of-Purchase
7. Where you purchased the product

Please contact Sanwa authorized agent / distributor / service provider, listed in our website, in your country with above information. An instrument sent to Sanwa / agent / distributor without above information will be returned to the customer.

Note:

- 1) Prior to requesting repair, please check the following:
Capacity of the built-in battery, polarity of installation and discontinuity of the test leads.
- 2) Repair during the warranty period:
The failed meter will be repaired in accordance with the conditions stipulated in 7-1 Warranty and Provision.
- 3) Repair after the warranty period has expired:
In some cases, repair and transportation cost may become higher than the price of the product. Please contact Sanwa authorized agent / service provider in advance.
The minimum retention period of service functional parts is 6 years after the discontinuation of manufacture. This retention period is the repair warranty period. Please note, however, if such functional parts become unavailable for reasons of discontinuation of manufacture, etc., the retention period may become shorter accordingly.
- 4) Precautions when sending the product to be repaired
To ensure the safety of the product during transportation, place the product in a box that is larger than the product 5 times or more in volume and fill cushion materials fully and then clearly mark "Repair Product Enclosed" on the box surface. The cost of sending and returning the product shall be borne by the customer.

7-3 SANWA web site

<http://www.sanwa-meter.co.jp>

E-mail: exp_sales@sanwa-meter.co.jp

[8] SPECIFICATIONS

8-1 General Specifications

Operation method	Δ - Σ method
AC measuring method	Average value method
LCD	4000 counts
Sampling rate	Approx. 3 times/sec.
Range selection	Auto and Manual (Some with Manual only or Auto only)
Over-range indication	“OL” shown in numerical part. (1000V DC/AC, 10A excluded.)
Polarity indication automatic selection	“-” indicated only when negative input.
Battery low warning	Battery () mark lights or flickers at approx. 2.4 V or below.
Environmental condition	Altitude 2000 m or below, pollution degree II.
Operating temperature / humidity	5°C to 40°C and humidity range as follows. No condensation allowed. At 5°C to 31°C, 80% RH (max). At 31°C to 40°C, linear drop from 80% RH to 50% RH.
Storage temperature / humidity	-10°C ~ 40°C, 80%RH max., no condensation 40°C ~50 °C, 70%RH max., no condensation (When the meter will not be used for a long time, remove the batteries before storage.)
Power supply	SUM-3 (R6), 2 pieces
Battery life	About 400 hours continuously at DCV. (Auto power off canceled)
Auto power off	Power off about 30 minutes after no operation.
Fuse	0.5A/1000V, Breaking capacity 30kA 10A/1000V, Breaking capacity 30kA
Safety standards	IEC61010-1 CAT.III 600V CAT.II 1000V IEC61010-031 : 2008
EMC Directive	IEC61326
Dimensions	166(L) X 82(W) X 44(D) mm (Projections not included)
Weight	Approx. 360 g (batteries included)
Power consumption	Typical 4.5mW (at DCV)
Standard accessories included	Test lead (TL-23a), Instruction manual
Optional accessories	Alligator clip: CL-11, CL-15, TL-8IC Clamp probe: CL-22AD, CL-33DC, CL-20D High voltage probe: HV-60 Carrying case: C-77, C77H

8-2 Measuring Range and Accuracy

Temperature: $23\pm 5^{\circ}\text{C}$, humidity: 80% RH max. (no condensation),
voltage 2.4 V or above.

rdg (reading): Read value, dgt (digit): Number of counts of last digit

DCV voltage

Range	Accuracy	Input Resistance	Remarks
400.0mV	$\pm(0.5\%rdg+2dgt)$	\geq Approx. 100M Ω	
4.000V	$\pm(0.9\%rdg+2dgt)$	Approx. 11M Ω	
40.00V		Approx. 10M Ω	
400.0V			
1000V			

ACV voltage

Range	Accuracy	Input Resistance	Remarks
4.000V	$\pm(1.2\%rdg+7dgt)$	Approx. 11M Ω	• Accuracy guarantee frequency range: 40Hz ~ 400 Hz (sinusoidal wave) If the frequency is above 1 kHz, measurement is not possible.
40.00V		Approx. 10M Ω	
400.0V			
1000V			

Resistance measurement

Range	Accuracy	Remarks
400.0 Ω	$\pm(1.2\%rdg+5dgt)$	• Open circuit voltage: Approx. 0.4 VDC • The measuring current varies depending on resistance of resistors to measure.
4.000k Ω		
40.00k Ω		
400.0k Ω		
4.000M Ω	$\pm(2.0\%rdg+3dgt)$	
40.00M Ω	$\pm(3.0\%rdg+3dgt)$	

Diode test

Open circuit voltage: Approx. 1.5 VDC

Continuity check

Buzzer sound and continuity lamp on range: 0 Ω ~ 85 Ω (± 45 Ω)

Open circuit voltage: Approx. 0.4 VDC

Battery check

Approx.. value (30 Ω load)

Special for 1.5-V battery

Frequency

Range	Accuracy	Remarks
5.000Hz	$\pm(0.3\%rdg+3dgt)$	<ul style="list-style-type: none"> • Auto range only • The data hold and relative functions cannot be used. • Sensitivity: 3 Vrms or over. • Frequency less than 1 Hz cannot be measured. • Input resistance \geq Approx. 2 kΩ • Because the input resistance is as low as approx. 2 kΩ, a large amount of current will flow during measurement. Never use the meter for measuring circuits or devices having a small current capacity. Never use the meter for measuring frequencies to ground as the earth leakage breaker may trip.
50.00Hz		
500.0Hz		
5.000kHz		
50.00kHz		
100.0kHz		

Capacitance

Range	Accuracy	Remarks
50.00nF	$\pm(5.0\%rdg+10dgt)$	<ul style="list-style-type: none"> • Accuracy after canceling the indicated value by the relative function. • Auto range only
500.0nF		
5.000 μ F		
50.00 μ F		
100.0 μ F		

DCA

Range	Accuracy	Input Resistance	Remarks
400.0 μ A	$\pm(1.4\%rdg+3dgt)$	Approx. 100 Ω	<ul style="list-style-type: none"> • The input resistance excludes the fuse resistance.
4000 μ A			
40.00mA		Approx. 1 Ω	
400.0mA			
4.000A	$\pm(2.0\%rdg+3dgt)$	Approx. 0.01 Ω	
10.00A			

ACA

Range	Accuracy	Input Resistance	Remarks
400.0 μ A	$\pm(1.8\%rdg+5dgt)$	Approx. 100 Ω	<ul style="list-style-type: none"> • Accuracy guarantee frequency range: 40 Hz ~ 400 Hz (sinusoidal wave) • The input resistance excludes the fuse resistance.
4000 μ A			
40.00mA		Approx. 1 Ω	
400.0mA			
4.000A	$\pm(2.4\%rdg+5dgt)$	Approx. 0.01 Ω	
10.00A			

* Maximum 20A can be measured if the measurement time is less than 10 seconds. (Take 10 minutes or longer intervals between measurements.)

* Accurate measurement may not be possible in places near a transformer, large-current line, etc. where a strong magnetic field is present or near radio equipment, etc. that generates a strong electric field.

Accuracy calculation

Example: DCV function

True value: 100 mV

Range accuracy: 400 mV range ... $\pm(0.5\%rdg+2dgt)$

Error: $\pm (100.0mV \times 0.5\% + 2dgt) = \pm 0.7mV$

Indicated value: 100.0mV $\pm 0.7mV$ (in a range of 99.3 mV and 100.7 mV)

The product specifications described in this manual and its appearance are subject to change without notice for improvement or other reasons.

sanwa®

三和電気計器株式会社

本社=東京都千代田区外神田2-4-4・電波ビル

郵便番号=101-0021・電話=東京(03)3253-4871(代)

大阪営業所=大阪市浪速区恵美須西2-7-2

郵便番号=556-0003・電話=大阪(06)6631-7361(代)

SANWA ELECTRIC INSTRUMENT CO.,LTD.

Dempa Bldg., 4-4 Sotokanda2-Chome Chiyoda-Ku,Tokyo,Japan