

SANWA®



PC7000

DIGITAL MULTIMETER

INSTRUCTION MANUAL



Table of Contents

[1] SAFETY PRECAUTIONS

1-1	Explanation of Warning Symbols	1
1-2	Warning Instructions for Safe Use	2
1-3	Overload Protection	3

[2] APPLICATIONS AND FEATURES

2-1	Applications	4
2-2	Features	4

[3] Parts Identification

3-1	Multimeter and Test Leads	5
3-2	Display	7

[4] DESCRIPTION OF FUNCTIONS

4-1	Power Switch/Function Selector	8
4-2	Auto Power Saving	8
4-3	Low Battery Indication	9
4-4	Measuring Function Selection	9
4-5	500000-count Display Mode	10
4-6	Range Hold	11
4-7	Data Hold	11
4-8	Beeper Control	11
4-9	PC (Personal Computer) Interface	12
4-10	Test Leads Improper Connection Warning	13
4-11	Crest capture mode (Sampling time: 0.8ms)	13
4-12	MAX/MIN/AVG Recording Mode.....	13
4-13	Relative Measurement	14
4-14	Back Light	14
4-15	Terms	14

[5] Measuring procedures

5-1	Pre-operational Check	16
5-2	Variable Frequency Drive (VFD) AC Voltage (\tilde{V})/Frequency (Hz) Measurement	18
5-3	AC Voltage (\tilde{V}), Decibel (dBm)/Frequency (Hz) Measurement	21
5-4	DC voltage (\bar{V})/AC Voltage (\tilde{V})/ DC+AC Voltage ($\tilde{\bar{V}}$) Measurement	24

5-5	DC Voltage (\bar{V})/AC Voltage (\tilde{V})/ DC+AC Voltage ($\tilde{\bar{V}}$), Logic-Level Frequency (\square Hz) and Duty Cycle (\square D%) Measurement	27
5-6	AC Voltage (\tilde{V}), Decibel (dBm)/Frequency (Hz) Measurement	31
5-7	Resistance (Ω) Measurement, Continuity Check (\bullet)), and Conductance (nS) Measurement	34
5-8	Temperature Measurement	37
5-9	Capacitance (H) Measurement, Diode ($\rightarrow $) Test	39
5-10	DC Current (\bar{A})/AC Current (\tilde{A})/DC+AC Current ($\tilde{\bar{A}}$), AC Current (\tilde{A}) / Frequency (Hz), and %4 ~ 20mA Measurement	43
5-11	Measurements with Separately Available Accessories	52

[6] MAINTENANCE

6-1	Simple Examination	56
6-2	Calibration	56
6-3	Battery and Fuse Replacement	57
6-4	Storage	58

[7] AFTER-SALE SERVICE

7-1	Warranty and Provision	59
7-2	Repair	59
7-3	SANWA web site	60

[8] SPECIFICATIONS

8-1	General Specifications	61
8-2	Measuring Range and Accuracy	63

[1] SAFETY PRECAUTIONS

***Before use, read the following safety precautions.**

This instruction manual explains how to use your digital multimeter PC7000. Before using, read through this manual to reduce the risk of fire, electric shock, and/or injury. And save it together with the product so that you can refer to the manual as necessary.

Use the instrument only as specified in this manual or the protection provided by the instrument may be impaired.

The instructions given under the headings of " ⚠ WARNING" and must be followed to prevent accidental burn and electric shock.

1-1 Explanation of Warning Symbols

The meanings of the symbols used in this manual and attached to the product are as follows.

⚠ :Extremely-important instructions for safe use

- WARNING identifies conditions and actions that could result in accidental burn and electric shock.
- CAUTION identifies conditions and actions that could cause damage the instrument.

⚡ :Do not touch! Possible high voltage.

⏏ :Ground

▶ :Diode

Hz:Frequency

⏏ :Fuse

•••••:Beep

⏏ Hz:Logic-Level Frequency

⏏ :Direct Current(DC)

⏏ :Capacitor

⏏ %:Duty Cycle

~ :Alternate Current (AC)

nS: Nano-Siemens (Conductance)

Ω:Resistance

Temp:Temperature

☀:Back light

□ : Double Insulation or Reinforced

1-2 Warning Instructions for Safe Use

⚠ WARNING

1. Do not use the instrument if the meter or test leads look damaged.
2. Be sure to use the specified fuse.
Neither use unspecified fuse nor short-circuit the fuse holder.
3. Do not apply higher voltage or current than the max. ratings by each function. (See 1-3)
4. Use caution when working with voltages above 33 V ac rms, 46.7 V ac peak, or 70 V dc. These voltages pose a shock hazard.
5. Do not use the meter to measure lines that may have inductive voltage or surge voltage (e.g. motors) because the input voltage may exceed the maximum rated voltage.
6. Never operate the meter with the case or battery lid removed.
7. Remove test leads from the meter before opening the meter case for replacing the battery or fuse.
8. Never attempt to repair or modify the instrument, except for battery and fuse replacement.
9. Do not use any unspecified type of test leads.
10. Keep your fingers behind the finger guards of the test leads while measurement.
11. Connect the common test lead (Black) before you connect the live test lead (Red). Disconnect the live test lead first.
12. Make sure the function, range, and measuring terminals are properly set.
13. Do not switch the function, range, or the plugs to another while measurement.
14. Do not operate the meter when it is wet or with wet hands.

⚠ CAUTION

Incorrect measurement may be performed in a ferromagnetic or intense electric field near transformers, high-current circuits, and radio equipments.

1-3 Overload Protection

Function	Measuring Terminal	Max. Rated Input	Overload Protection
$\left[\begin{matrix} \text{Hz} \\ \text{LPF} \end{matrix} \tilde{V} \right]$, $\left[\begin{matrix} \text{Hz} \\ \text{dBm} \end{matrix} \tilde{V} \right]$ $\left[\begin{matrix} \text{V} \\ \text{V} \end{matrix} \right]$	$\left[\begin{matrix} \text{V} \text{ Hz } \Omega \\ \text{Temp} \\ \text{nS} \end{matrix} \right]$ and COM	1000V dc/ac	1050V rms, 1450V peak
$\left[\begin{matrix} 0\% \\ \text{Hz} \end{matrix} \tilde{mV} \right]$, $\left[\begin{matrix} \text{Hz} \\ \text{dBm} \end{matrix} \tilde{mV} \right]$		5V dc/ac	600Vrms
$\left[\begin{matrix} \text{nS} \\ \Omega \end{matrix} \right]$, $\left[\begin{matrix} \text{A} \\ \text{A} \end{matrix} \right]$		⚠ Do not apply any voltage or current.	
$\left[\text{Temp} \right]$		50mV dc	
$\left[\begin{matrix} \text{A} \\ \text{mA} \end{matrix} \right]$, $\left[\begin{matrix} \text{A} \\ \mu\text{A} \end{matrix} \right]$	mA μ A and COM	600mA dc/ac ⚠ Do not apply any voltage.	0.63A/500V Fuse Breaking capacity: 50kA
$\left[\begin{matrix} \text{A} \\ \text{mA} \end{matrix} \right]$	A and COM	10A dc/ac ⚠ Do not apply any voltage.	12.5A/500V Fuse Breaking capacity: 20kA

[2]APPLICATIONS AND FEATURES

2-1 Applications

This instrument is a portable digital multimeter designed to measure light electric circuits. The instrument offers not only measurements for small communication equipments, home electric appliances, output from a wall socket, and many batteries, also circuit analyses with additional functions.

2-2 Features

- Compliant with IEC61010-1 CAT. III 600V, CAT. II 1000V, and safe design using fuses with large number of breaking capacity.
- 50000-count display (DCV, ACV, DCA, ACA, Ohm)
- 500000-count display (DCV)
- 99999-count display (Hz)
- Fast response display
 (Numeric parts: 5 times/Sec. Bar graph part: 60 times/Sec. where 50000-count display mode)
- Dual Display shows "Voltage or Current and its Frequency", and "AC components and DC components of Voltage or Current"
- True RMS detection for alternate current (AC) (True RMS)
- DC+AC indications available
- Low-pass filter for Variable Frequency Drive (VFD) circuit
- dBm indication for decibel measurement
- Resolution: 0.001 mV for DCV, 0.01mV for ACV
- Frequency (Sensitivity selectable),
 Wide capacitance range (0.01nF to 25.00mF)
- Automatically range selectable Crest Capture Mode
 Sampling time: Approx. 0.8ms
- MAX/MIN/AVG recording mode with auto ranging
- Relative mode with auto ranging
- Back light to allow for easy visibility in low-lit area
- Temperature measurement
 (K-type thermocouple: -50 °C to 1000 °C)
- PCLink7 (separately available software) allows you to download logged data into your PC with USB optical communication unit (KB-USB7)

3-2 Display

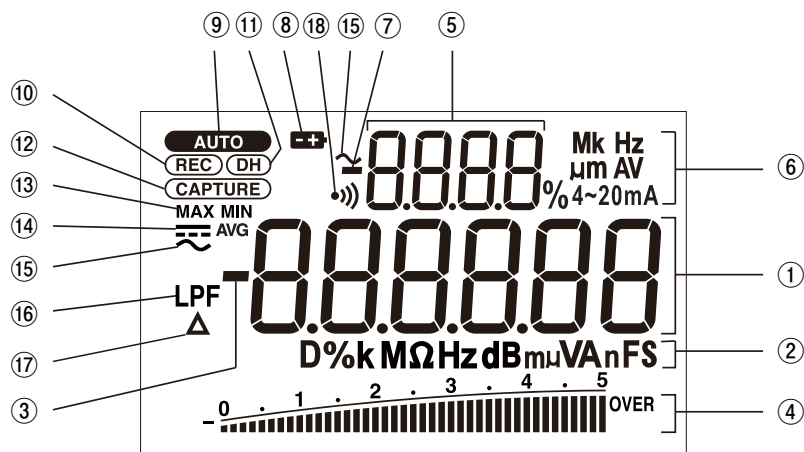

①	Main display
②	Unit of readings for main display
③	Polar character for main display
④	Analog bar graph
⑤	Sub display
⑥	Unit of readings for sub display
⑦	Polar character for sub display
⑧	Low battery voltage indicator
⑨	Auto range mode indicator
⑩	Recording mode indicator
⑪	Data hold indicator
⑫	Crest capture mode indicator
⑬	Max/Min/Avg updating indicator
⑭	DC measurement indicator
⑮	AC measurement indicator
⑯	Low-pass filter operation indicator
⑰	Relative mode indicator
⑱	Continuity check indicator

[4] DESCRIPTION OF FUNCTIONS

4-1 Power Switch/Function Selector

Turn the switch to turn on/off the power and select a measuring function. All segments of the LCD display will be turned on for 1 second after power-on, and then the meter will be ready to use.

Note:

The push buttons between the display and the function selector work differently depending on how long you press. In this manual, "press" means pressing momentary and "press for 1 sec. or more" means pressing longer.

4-2 Auto Power Saving

The Auto Power Saving mode turns the meter off automatically after approximately 17 minutes of no activities. While the Auto Power Saving mode, the following activities set the Auto Power Saving back.

- 1) Function selector or push button operations
- 2) Non-OL readings in the Ω function, non-zero readings in the Duty cycle/Frequency measurement functions, any readings in the temperature measurement function, or significant measuring readings of above 9% of fullscale in the other function ranges.

Following activities disable the Auto Power Saving mode automatically.

- 1) Crest capture mode or MAX/MIN/AVG recording mode is in use
- 2) Data communication to your PC is in use

4-2-1 How to get back from the Auto Power Saving

Press the **SELECT**, **RANGE HOLD**, **△ REL**, or **HOLD** button, or disconnect the object to measure and turn the power switch off and then back on, and select a function before connecting the object.

4-2-2 How to disable the Auto Power Saving

Press the **SELECT** button while turning the meter power on. Release the **SELECT** button after **dSAPO** is indicated. (All segments of the display turn on right after power-on, then **dSAPO** will be indicated. **dSAPO** means that the Auto Power Saving is disabled.) Then the meter will be ready to use. Turn the power switch OFF and then back on to resume.

Note:

Even in the Auto Power Saving mode, approx. 70 μA will be consumed. When in the auto power saving mode, intense light like the direct sunlight into the optical communication unit on the back of the DMM increases the consumption current. To prevent unexpected battery wearing down, mount the attached light shielding magnet cap on the optical communication unit connector when not in use. Always turn the power switch to the OFF position when the meter is not in use for a long time.

4-3 Low Battery Indication

Decreasing the internal battery voltage to approx. 7V due to wearing down turns on the  indicator on the LCD display. Replace the battery with new one when the indicator turns on. Use under "Low Battery" may cause malfunctions.

4-4 Measuring Function Selection

At each position of the function selector, press SELECT button (\Rightarrow) to select measuring functions as follows.

* Dual display: [Main display/Sub display]

- $\left[\begin{array}{c} \text{Hz} \\ \text{LPF} \end{array} \tilde{\text{V}} \right] : [\tilde{\text{V}}/\text{Hz}] \Leftrightarrow [\text{Hz}/\tilde{\text{V}}]$
- $\left[\begin{array}{c} \text{Hz} \\ \text{dBm} \end{array} \tilde{\text{V}} \right] : [\tilde{\text{V}}/\text{Hz}] \Rightarrow [\text{dBm}/\text{Hz}] \Rightarrow [\text{Hz}/\tilde{\text{V}}] \Rightarrow [\tilde{\text{V}}/\text{Hz}] \dots$
- $\left[\begin{array}{c} \tilde{\text{V}} \\ \tilde{\text{V}} \end{array} \right] : [\tilde{\text{V}}] \Rightarrow [\tilde{\text{V}}/\tilde{\text{V}}] \Rightarrow [\tilde{\text{V}}/\tilde{\text{V}}] \Rightarrow [\tilde{\text{V}}] \dots$
- $\left[\begin{array}{c} \text{D}\% \\ \text{mV} \end{array} \right] : [\text{m}\tilde{\text{V}}] \Rightarrow [\text{m}\tilde{\text{V}}/\text{m}\tilde{\text{V}}] \Rightarrow [\text{m}\tilde{\text{V}}/\text{m}\tilde{\text{V}}] \Rightarrow [\text{D}\%] \Rightarrow [\text{m}\tilde{\text{V}}] \dots$
- $\left[\begin{array}{c} \text{Hz} \\ \text{dBm} \end{array} \text{m}\tilde{\text{V}} \right] : [\text{m}\tilde{\text{V}}/\text{Hz}] \Rightarrow [\text{dBm}/\text{Hz}] \Rightarrow [\text{Hz}/\text{m}\tilde{\text{V}}] \Rightarrow [\text{m}\tilde{\text{V}}/\text{Hz}] \dots$
- $\left[\begin{array}{c} \text{nS} \\ \Omega \end{array} \right] : [\Omega] \Rightarrow [\bullet] \Rightarrow [\text{nS}] \Rightarrow [\Omega] \Rightarrow \dots$

- $\left[\text{Temp} \right] : [\text{C}] \Leftrightarrow [\text{F}] (\text{C: } ^\circ\text{C} , \text{F: } ^\circ\text{F})$
- $\left[\begin{array}{c} \text{A} \\ \text{mA} \end{array} \right] : [\text{A}] \Leftrightarrow [\text{mA}]$
- $\left[\begin{array}{c} \text{A} \\ \text{mA} \end{array} \right] : \text{When a test lead is not connected to measuring terminal } \mathbf{A}$
 $[\text{m}\tilde{\text{A}}/\%4 \sim 20\text{mA}] \Rightarrow [\text{m}\tilde{\text{A}}/\text{m}\tilde{\text{A}}] \Rightarrow [\tilde{\text{A}}/\text{m}\tilde{\text{A}}] \Rightarrow [\text{m}\tilde{\text{A}}/\text{Hz}] \Rightarrow [\text{m}\tilde{\text{A}}/\%4 \sim 20\text{mA}] \dots$
 When a test lead is connected to terminal \mathbf{A} ,
 $[\tilde{\text{A}}] \Rightarrow [\tilde{\text{A}}/\tilde{\text{A}}] \Rightarrow [\tilde{\text{A}}/\tilde{\text{A}}] \Rightarrow [\tilde{\text{A}}/\text{Hz}] \Rightarrow [\tilde{\text{A}}] \dots$
- $\left[\begin{array}{c} \mu\text{A} \\ \text{Hz} \end{array} \right] : [\mu\tilde{\text{A}}] \Rightarrow [\mu\tilde{\text{A}}/\mu\tilde{\text{A}}] \Rightarrow [\mu\tilde{\text{A}}/\mu\tilde{\text{A}}] \Rightarrow [\mu\tilde{\text{A}}/\text{Hz}] \Rightarrow [\mu\tilde{\text{A}}] \dots$

Note:

The last selection of each function will be saved as power up default for repeat measurement convenience.

4-5 500000-count display mode

Press the **500000** (\triangle REL) button for 1 second or more to turn the 500000-count display mode on. It is available to single display DC Voltage function ranges. Measuring speed is reduced to 1.25 times per second. To turn the 500000-count display mode off, press the **500000** (\triangle REL) button for 1 sec. or more again, or press **SELECT** button to change the display mode.

4-6 Range Hold

Press the **RANGE HOLD** button to select manual-ranging, and the meter will remain in the range it was in. (**AUTO** turns off.) In the manual-ranging mode, press the button again to step through the ranges. Select an appropriate range making sure units and decimal point positions. To resume auto-ranging mode, press and hold the button for 1 second or more.

Note:

Manual ranging mode is not available in the Hz functions.

4-7 Data Hold

Press **HOLD** button to freeze present reading for later view. (**DH** indicator turns on.) Input fluctuation will not reflect on the indicated value. Press the **HOLD** button again to disable the data hold feature and go back to the normal measurement mode. (**DH** indicator turns off.)

Note:

Function changes or functional operations will cancel the data hold feature.

4-8 Beeper Control

Press the **RANGE HOLD** button while turning the meter power on to disable the beeper. Release the **RANGE HOLD** button after **•••** is turned off. (All segments of the display turn on right after power-on.) Then the meter will be ready to use. Turn the power switch OFF and then back on to resume.

Note:

The beeper for the continuity check and the plug improper connection warning will not be disabled.

4-9 PC (Personal Computer) Interface

The instrument equips with an optical isolated interface port at the meter back for data communication. KB-USB7, dedicated USB optical communication unit (separately available), and PCLink7, dedicated software, allow you to transfer real time readings and internally logged data to your PC. For more information, see the "HELP" for PCLink7 (PC linkage software).

USB Optical Communication Unit
(KB-USB7)

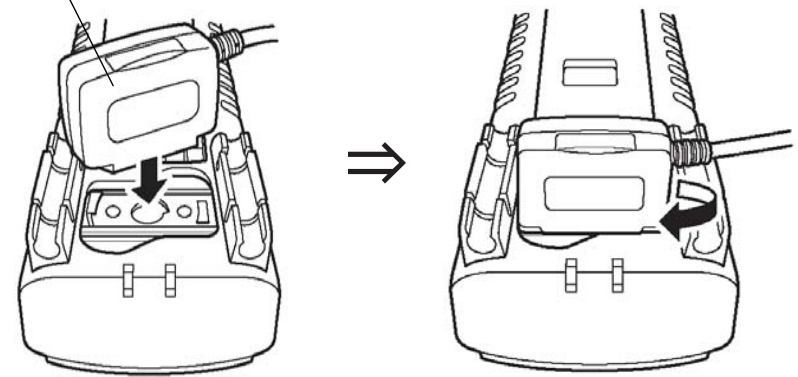

Optical Communication Unit Connection

Note:

Intense light like the direct sunlight into the optical communication unit on the back of the DMM increases the consumption current. Mount the attached light shielding magnet cap on the optical communication unit connector when not in use.

4-10 Test Leads Improper Connection Warning

The meter beeps as well as displays “InErr” to warn the user against possible damage to the meter due to test leads improper connections to the mA μ A, or A measuring jacks when other function (like voltage function) is selected. (Temperature measurement function is an exception.)

Note:

“InErr” warning may be indicated due to weak battery even if the test leads are connected properly.

4-11 Crest capture mode (Sampling time: 0.8ms)

Press the **CAPTURE** button to activate the crest (Instantaneous Peak-Hold) mode to capture voltage or current signal duration which is longer than 0.8ms. **CAPTURE** and **MAX** indicator turns on. The meter beeps when new MAX (maximum) or MIN (minimum) reading is updated. Press the button to read the MAX, MIN, and MAX-MIN (peak to peak) readings in sequence. Press the button for 1 sec. or more to exit the crest mode. Auto-ranging (up range) remains, and Auto Power Saving is disabled automatically in this mode.

4-12 MAX/MIN/AVG Recording Mode

Press the **REC** button to activate the MAX/MIN/AVG recording mode, and **REC**, **MAX**, **MIN**, and **AVG** turn on. The meter beeps when new MAX (maximum) or MIN (minimum) reading is updated. Press the button to show the MAX, MIN, MAX-MIN (peak to peak), and AVG readings in sequence. Press the button for 1 sec. or more again to exit the MAX/MIN/AVG recording mode. Auto-ranging remains, and Auto Power Saving is disabled automatically in this mode.

4-13 Relative Measurement

Press the \triangle **REL** button to activate the relative measurement mode and \triangle indicator turns on. The relative measurement mode offsets the meter to display relative values against a reference. The meter displays its readings subtracting the reading at the moment the \triangle **REL** button is pressed. Press the \triangle **REL** button again to exit the relative measurement mode. This feature is available also while the MAX/MIN/AVG recording mode.

4-14 Back Light

Press the **SELECT** button for 1 sec. or more to turn the backlight on. (Automatically turns off after approx. 15sec.) Press the **SELECT** button again for 1 sec. or more to turn the backlight off.

4-15 Terms

Analog bar graph



The analog bar graph provides a visual indication of measurement like a traditional analog meter needle.

True RMS

True RMS is a term which identifies a DMM that responds accurately to the effective RMS value regardless of the waveforms such as square, sawtooth, triangle, pulse trains, spikes, as well as distorted waveforms with the presence of harmonics. This instrument employs the True-RMS (Root-Mean-Square) detection.

Crest Factor

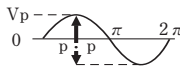
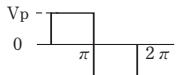
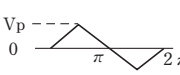
Crest Factor is the ratio of the Crest (instantaneous peak) value divided by the True RMS value. Most common waveforms such as sinusoidal wave and chopping wave have a relatively low crest factor. A low duty cycle wave form like pulse string has a high crest factor. For voltages and crest factors for typical waveforms, see the table below.

	Input Waveform	0 to PEAK V_p	Root Mean Square Value V_{rms}	Average Value V_{avg}	Crest Factor V_p/V_{rms}	Form Factor V_{rms}/V_{avg}
Sinusoidal wave		V_p	$\frac{V_p}{\sqrt{2}}$ $=0.707V_p$	$\frac{2V_p}{\pi}$ $=0.637V_p$	$\sqrt{2}$ $=1.414$	$\frac{\pi}{2\sqrt{2}}$ $=1.111$
Square wave		V_p	V_p	V_p	1	1
Chopping wave		V_p	$\frac{V_p}{\sqrt{3}}$ $=0.577V_p$	$\frac{V_p}{2}$ $=0.5V_p$	$\sqrt{3}$ $=1.732$	$\frac{2}{\sqrt{3}}$ $=1.155$
Pulse		V_p	$\sqrt{\frac{\tau}{2\pi}} \cdot V_p$	$\frac{\tau}{2\pi} \cdot V_p$	$\sqrt{\frac{2\pi}{\tau}}$	$\sqrt{\frac{2\pi}{\tau}}$

[5] Measuring procedures

5-1 Pre-operational Check

⚠ WARNING

1. Do not use the instrument if the meter or test leads look damaged.
2. Make sure the test leads and the fuse are not broken.

⚠ CAUTION

Make sure the low battery indicator is off after power-on. Replace the battery with new one if the indicator is on.

Perform pre-operational check for safety.

(Inspection using continuity check)

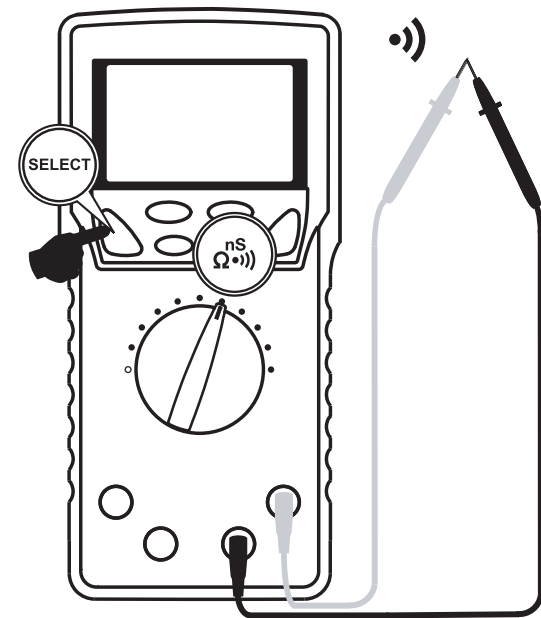

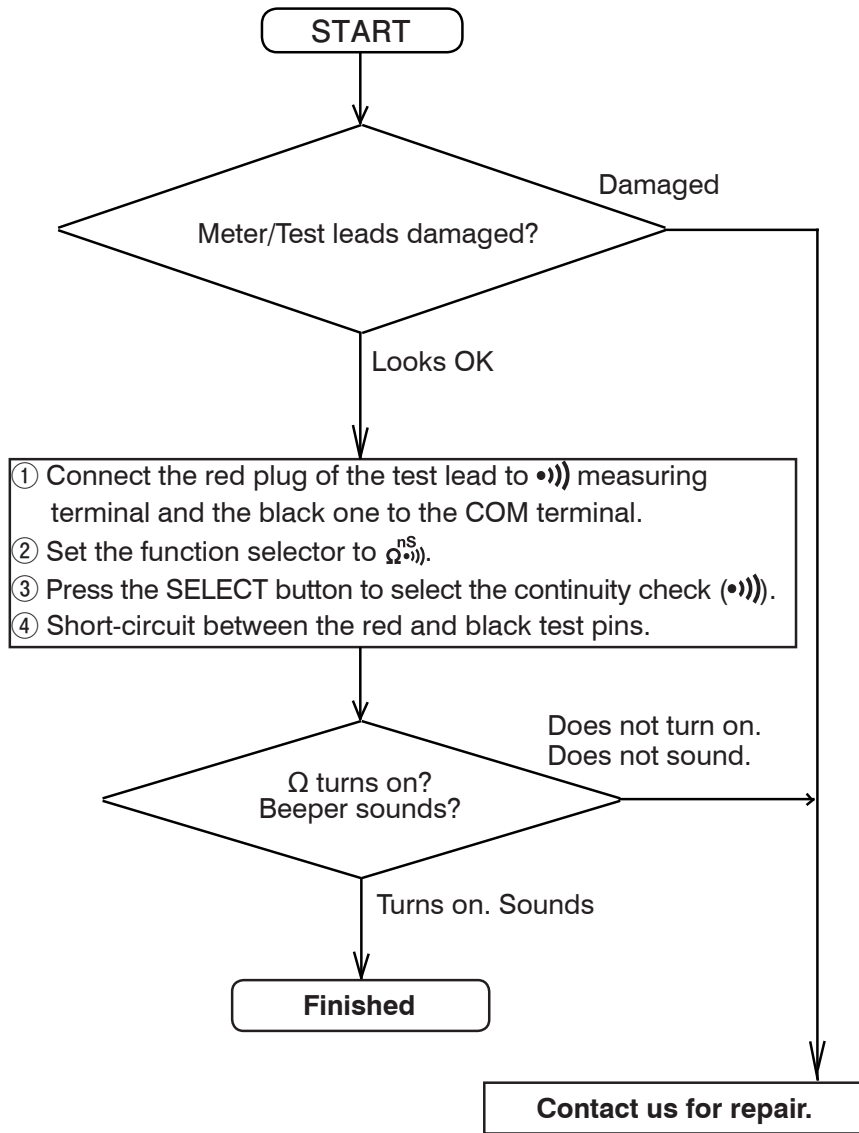

*In the case nothing is displayed, check for the battery.

5-2 $\left[\begin{matrix} \text{Hz} \\ \text{LPF} \end{matrix} \tilde{V} \right]$ (Max. rated input voltage: 1,000V dc/ac)

- AC Voltage (\tilde{V})/Frequency (Hz) simultaneous measurement for Variable Frequency Drive (VFD) through the Low-pass filter (LPF)

⚠ WARNING

1. Do not apply any input signal exceeding the max. rated input voltage.
2. Do not switch the function selector while measuring.
3. Keep your fingers behind the finger guards of the test leads while measurement.

1) What to measure

- \tilde{V} (ACV): Output voltages with a lot of harmonics from variable frequency drives (VFD) such as inverters, and sine wave voltages such as output from a wall socket.
- Hz (Frequency): Frequency on the above circuit and so on.

2) Measuring ranges

- \tilde{V} : 5.0000V, 50.000V, 500.00V and 1000.0V
- Hz: 10.00Hz to 440.0Hz (Auto ranging)

3) Measuring procedure

- ① Connect the red plug of the test lead to the **VHz** measuring terminal and the black one to the **COM** terminal.
- ② Set the function selector to $\begin{matrix} \text{Hz} \\ \text{LPF} \end{matrix} \tilde{V}$.
- ③ Press the **SELECT** button to select a display style.
- ④ Apply the test pins (Red and Black) to the object to measure.
- ⑤ Read the display.

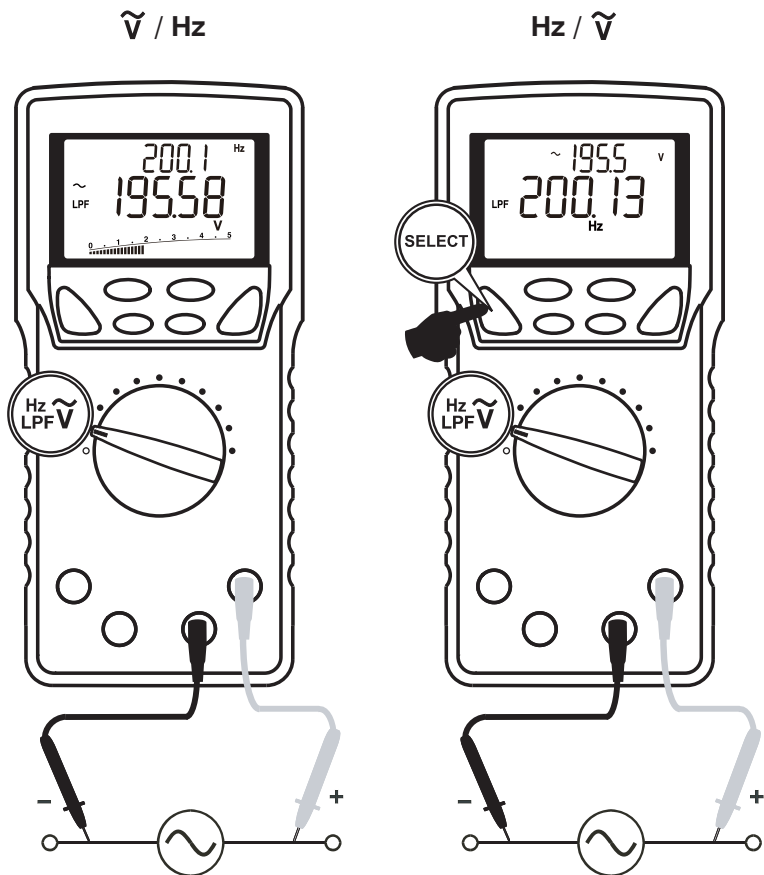

Note:

- Press the **SELECT** button to alternately change the display style.
- By default, voltage is always set at manual-range 500V to best cope with most Variable Frequency Drives (VFD) measurements. Press the **RANGE** button to select other ranges only when needed. This function has only manual-ranges.
- Hz input sensitivity varies automatically with a selected voltage range. 5.0000V range has the highest sensitivity and the 1000.0V range has the lowest sensitivity. This function normally set the most appropriate trigger level for most Variable Frequency Drives. You can also press the **RANGE HOLD** button to manually select other trigger levels (voltage range). If the Hz reading becomes unstable, select higher voltage range to avoid electrical noise. If the reading shows zero, select lower voltage range.

Range	Frequency measurement (Hz) Input sensitivity (Sine wave)	Frequency range
5.0000Vac	0.5 ~ 2V	10.00Hz ~ 440.0Hz
50.000Vac	5 ~ 20V	
500.00Vac	50 ~ 200V	10.00Hz ~ 200.0Hz
1000.0Vac	500 ~ 1000V	

- The display style of [Hz/ V~] does not show the bar graph.
- As a normal condition, non-connected test leads may cause unstable readings.

5-3 $\left[\begin{matrix} \text{Hz} \\ \text{dBm} \end{matrix} \tilde{V} \right]$ (Max. rated input voltage: 1,000V dc/ac)

- AC Voltage (\tilde{V}), Decibel (dBm) / Frequency (Hz) simultaneous measurement

⚠ WARNING

1. Do not apply any input signal exceeding the max. rated input voltage.
2. Do not switch the function selector while measuring.
3. Keep your fingers behind the finger guards of the test leads while measurement.

1) What to measure

- \tilde{V} (ACV): Sine wave voltages such as output from a low-frequency amplifier and a wall socket.
- Hz (Frequency): Frequency on the above circuit and so on.

2) Measuring ranges

- \tilde{V} : 5.0000V, 50.000V, 500.00V and 1000.0V
- Hz: Auto ranging

3) Measuring procedure

- ① Connect the red plug of the test lead to the **VHz** measuring terminal and the black one to the **COM** terminal.
- ② Set the function selector to $\begin{matrix} \text{Hz} \\ \text{dBm} \end{matrix} \tilde{V}$.
- ③ Press the **SELECT** button to select a display style.
- ④ Apply the test pins (Red and Black) to the object to measure.
- ⑤ Read the display.

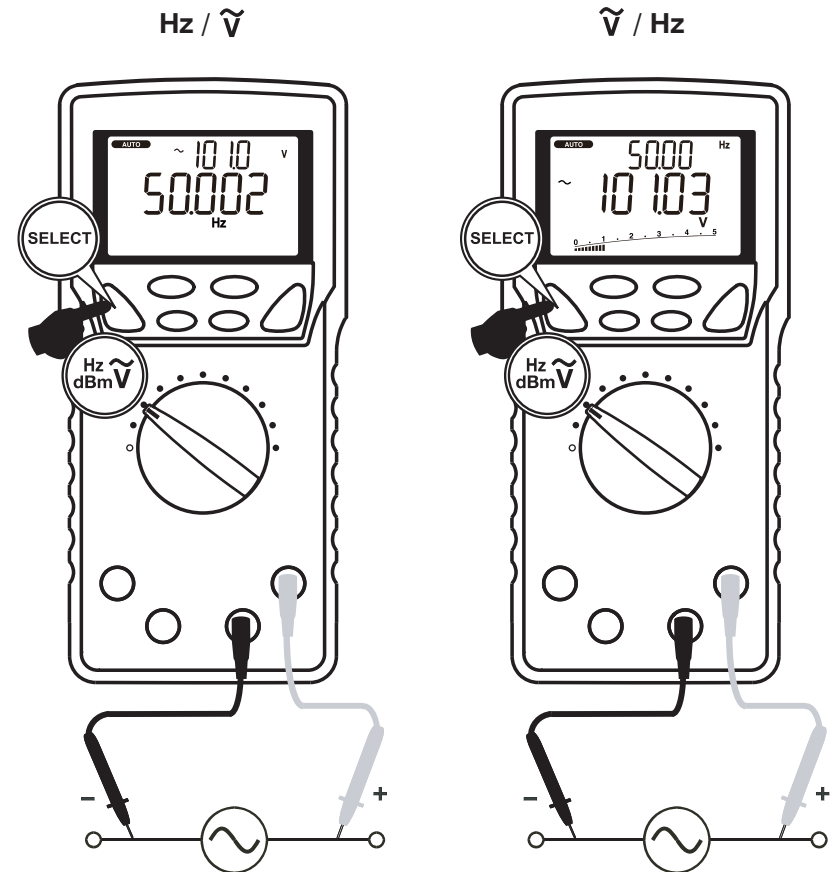

Indicaion in dBm:

After pressing the **SELECT** button to change the function to the dBm measurement from the ACV measurement, and after turning on the power of this multimeter, the latest reference impedance will be displayed before displaying the dBm readings. Press **dBm-Ω (RANGE)** button to select different reference impedance of 4, 8, 16, 32, 50, 75, 93, 110, 125, 135, 150, 200, 250, 300, 500, 600, 800, 900, 1000, up to 1200Ω.

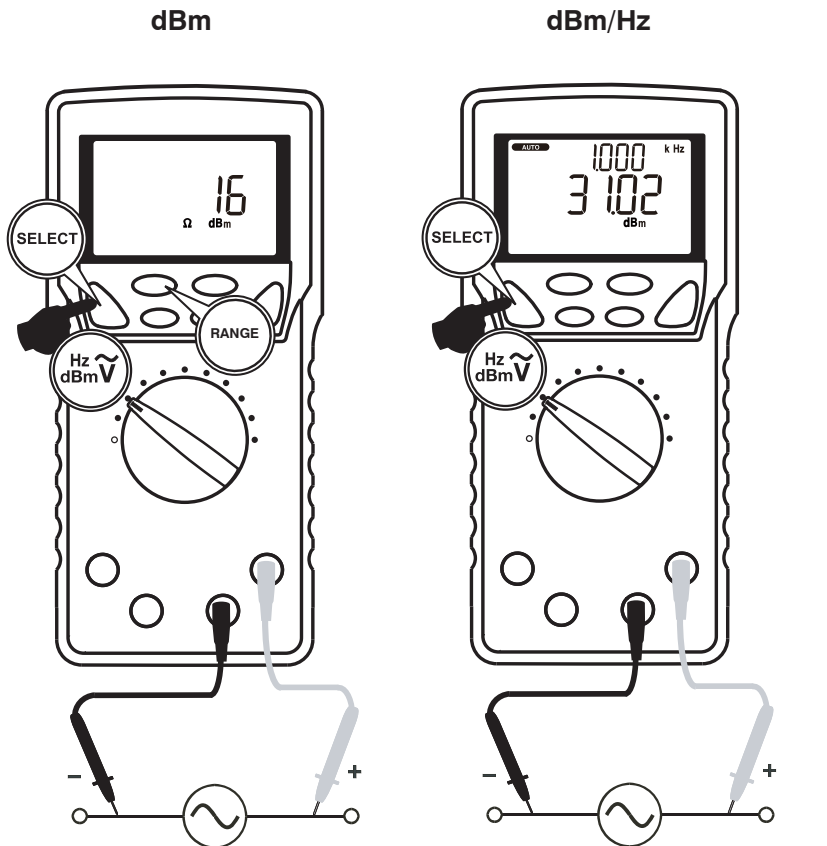

Range	Frequency measurement (Hz) Input sensitivity (Sine wave)	Frequency range
5.0000Vac	0.5V	10.00Hz ~ 200.0kHz
50.000Vac	5V	10.00Hz ~ 100.0kHz
500.00Vac	50V	
1000.0Vac	500V	10.00Hz ~ 10.00kHz

- The display style of [\tilde{V}/Hz] shows the bar graph.
- As a normal condition, non-connected test leads may cause unstable readings.
- Manual trigger level selection on Hz reading is not available in this function.

5-4 [$\overline{\tilde{V}}$] (Max. rated input voltage: 1,000V dc/ac)

- DC Voltage ($\overline{\tilde{V}}$) measurement
- DC Voltage ($\overline{\tilde{V}}$)/AC Voltage (\tilde{V}) simultaneous measurement
- DC+AC voltage ($\overline{\tilde{V}}$)/AC Voltage (\tilde{V}) simultaneous measurement

⚠ WARNING

1. Do not apply any input signal exceeding the max. rated input voltage.
2. Do not switch the function selector while measuring.
3. Keep your fingers behind the finger guards of the test leads while measurement.

1) What to measure

- $\overline{\tilde{V}}$ (DC Voltage): Batteries, DC circuit voltages, etc.
- $\overline{\tilde{V}}/\tilde{V}$ (DC voltage component/AC voltage component)
- $\overline{\tilde{V}}/\tilde{V}$ (DC/AC superimposed signal voltage/AC voltage component)

2) Measuring ranges

- $\overline{\tilde{V}}$, $\overline{\tilde{V}}/\tilde{V}$, $\overline{\tilde{V}}/\tilde{V}$:
5.0000V, 50.000V, 500.00V, 1000.0V
- $\overline{\tilde{V}}$ (in the 500000-count display mode):
5.00000V, 50.0000V, 500.000V, 1000.00V

3) Measuring procedure

- ① Connect the red plug of the test lead to the **V** measuring terminal and the black one to the **COM** terminal.
- ② Set the function selector to $\overline{\tilde{V}}$.
- ③ Press the **SELECT** button to select a function you want to perform.
- ④ Apply the test pins (Red and Black) to the object to measure.
- ⑤ Read the display.

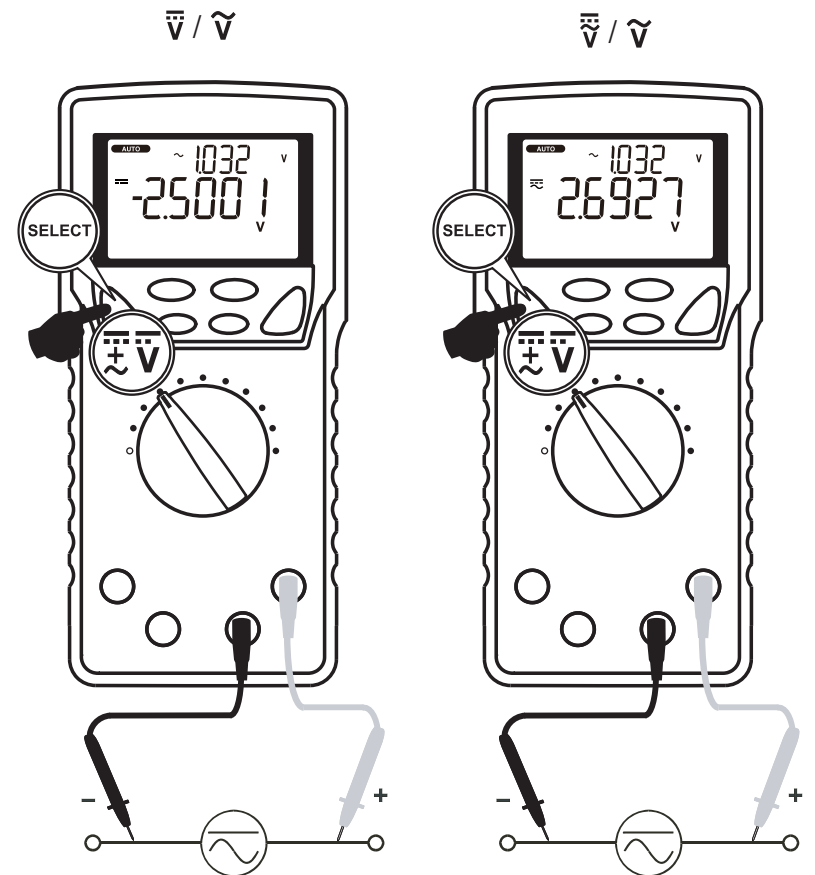
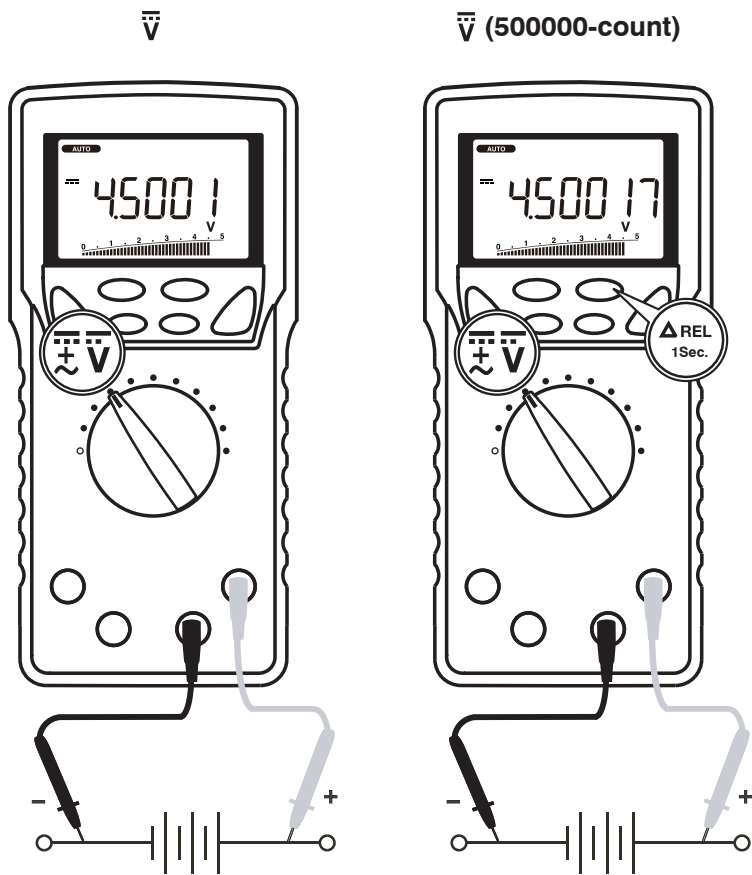

Note:

- Press the **500000** (Δ **REL**) button for 1 second or more to turn the 500000-count display mode on. It is available to single display DC Voltage function ranges. Measuring speed is reduced to 1.25 times per second. To turn the 500000-count display mode off, press the **500000** (Δ **REL**) button for 1 sec. or more again, or press **SELECT** button to change the display mode.
- The display style of [\bar{V} / \tilde{V}] or [$\bar{V} / \Delta \tilde{V}$] does not show the bar graph.

5-5 $\left[\frac{D\%}{\mu\text{Hz}} \overline{\text{mV}} \right]$ (Max. rated input voltage: 10V dc/ac)

- DC voltage (mV̄) measurement
- DC Voltage (mV̄)/AC Voltage(mV̇) simultaneous measurement
- DC+AC Voltage (mV̄V̇)/AC Voltage (mV̇) simultaneous measurement
- Logic-level frequency (μHz) measurement
- Duty cycle (μD%) measurement

⚠ WARNING

1. Do not apply any input signal exceeding the max. rated input voltage.
2. Do not switch the function selector while measuring.
3. Keep your fingers behind the finger guards of the test leads while measurement.

1) What to measure

- mV̄ (DC voltage): DC circuit voltage lower than 500mV
- mV̄ / mV̇ (DC voltage component/AC voltage component)
- mV̄V̇ / mV̇ (DC/AC superimposed signal voltage/AC voltage component)
- μHz (Logic level frequency): 3V, 5V logic circuit frequency
- μD% (Duty cycle): Logic level signal duty cycle (Square wave)

2) Measuring ranges

- mV̄, mV̄ / mV̇, mV̄V̇ / mV̇ : 500.00mV (fixed)
- mV̄ (500000-count display mode): 500.000mV (fixed)
- μHz: Auto ranging, 5.000Hz to 1.000MHz (Square wave)
- μD%: 0.1% to 199.9% (Square wave 5Hz to 500kHz)

3) Measuring procedure

- ① Connect the red plug of the test lead to the **VHz** measuring terminal and the black one to the **COM** terminal.
- ② Set the function selector to $\frac{D\%}{\mu\text{Hz}} \overline{\text{mV}}$.
- ③ Press the SELECT button to select a function you want to perform.
- ④ Apply the test pins (Red and Black) to the object to measure.
- ⑤ Read the display.

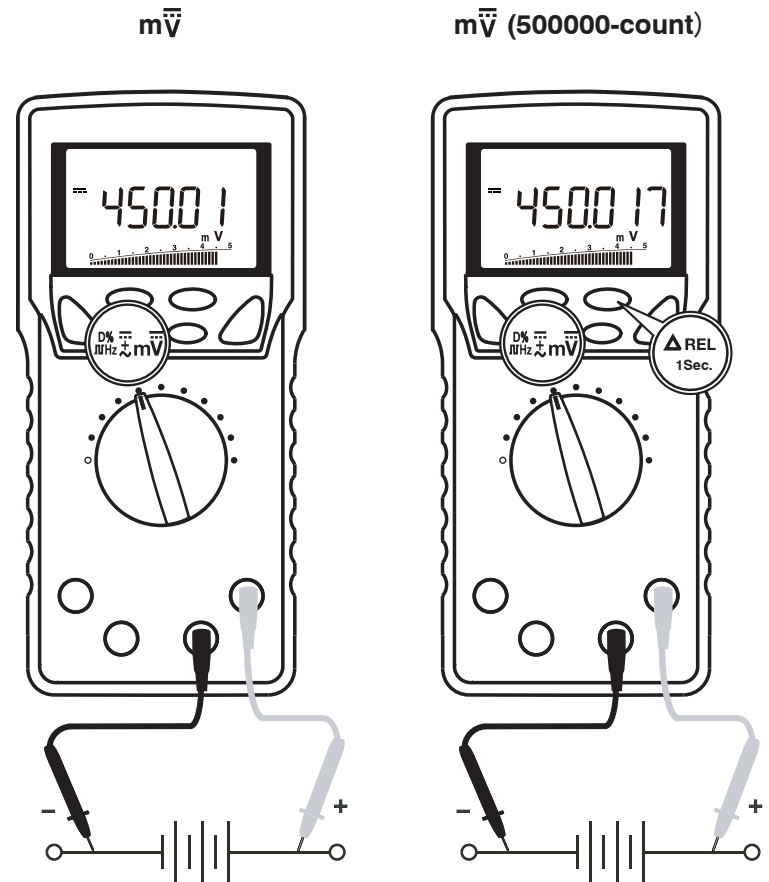

mV̄ / mV̂

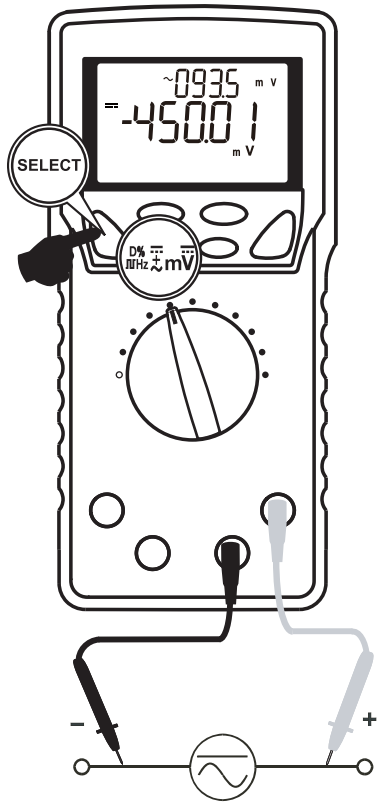

mV̄̄ / mV̂̄

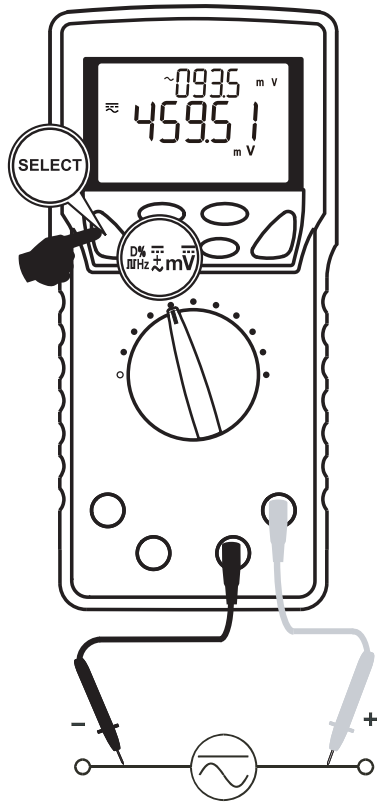

μHz

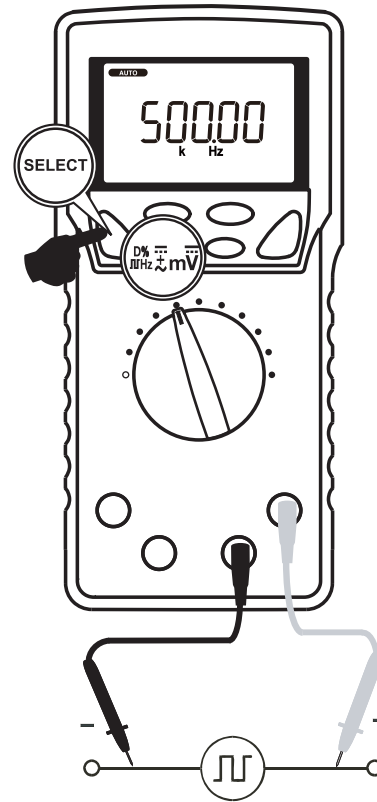

μD%

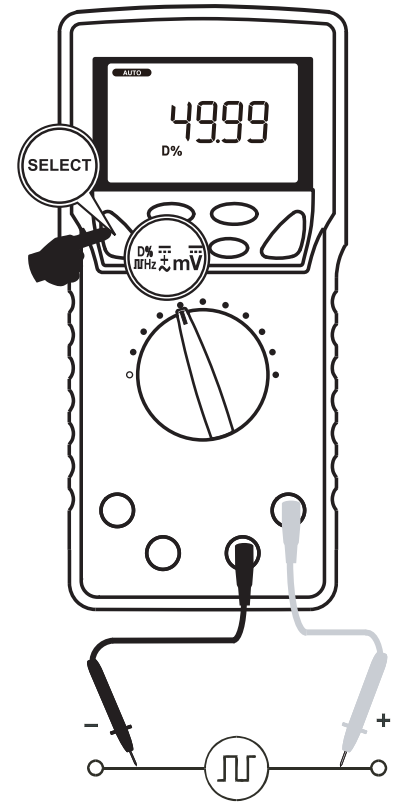

Note:

- The display style of [mV̄ / mV̂], [mV̄̄ / mV̂̄], [μHz], or [μD%] does not show the bar graph.

5-6 $\left[\frac{\text{Hz}}{\text{dBm}} \text{m}\tilde{\text{V}} \right]$ (Max. rated input voltage: 500mV dc/ac)

- AC Voltage (m $\tilde{\text{V}}$), Decibel (dBm) / Frequency (Hz) simultaneous measurement

⚠ WARNING

1. Do not apply any input signal exceeding the max. rated input voltage.
2. Do not switch the function selector while measuring.
3. Keep your fingers behind the finger guards of the test leads while measurement.

1) What to measure

- **m $\tilde{\text{V}}$** (AC voltage): Sine wave AC voltage lower than 600mV such as output from a low-frequency amplifier.
- **Hz** (Frequency): Frequency on the above circuit

2) Measuring ranges

- **m $\tilde{\text{V}}$** : 500.00mV (fixed)
- **Hz**: 10.00Hz ~ 200.0kHz (Auto ranging)

3) Measuring procedure

- ① Connect the red plug of the test lead to the **VHz** measuring terminal and the black one to the **COM** terminal.
- ② Set the function selector to $\frac{\text{Hz}}{\text{dBm}} \text{m}\tilde{\text{V}}$.
- ③ Press the **SELECT** button to select a function you want to perform.
- ④ Apply the test pins (Red and Black) to the object to measure.
- ⑤ Read the display.

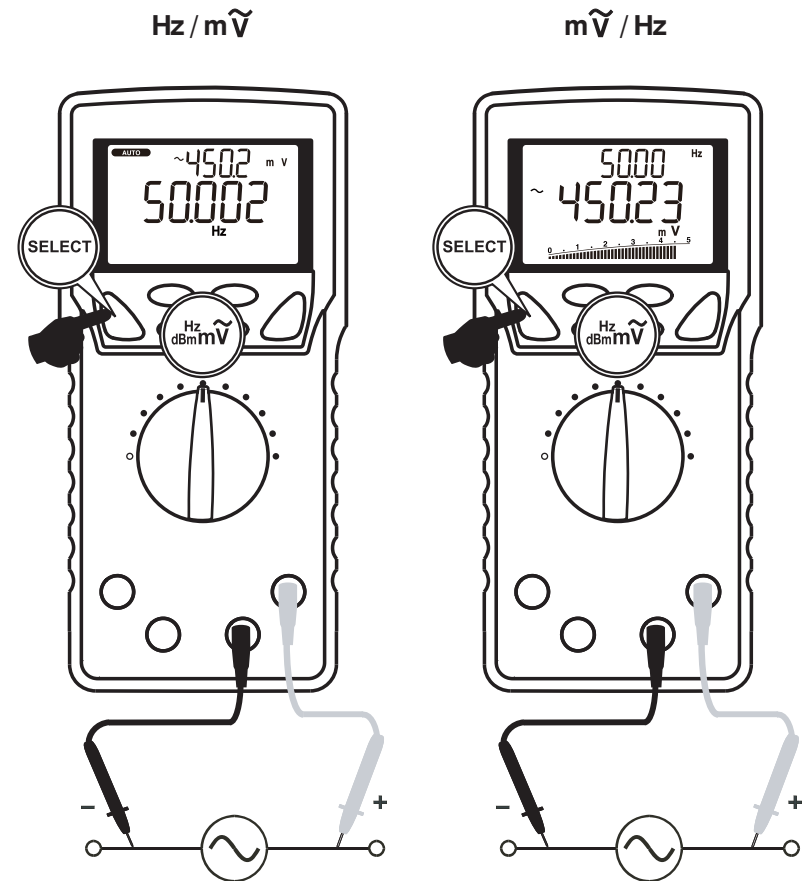

Indicaion in dBm:

After pressing the **SELECT** button to change the function to the dBm measurement from the ACV measurement, and after turning on the power of this multimeter, the latest reference impedance will be displayed before displaying the dBm readings. Press **dBm-Ω (RANGE)** button to select different reference impedance of 4, 8, 16, 32, 50, 75, 93, 110, 125, 135, 150, 200, 250, 300, 500, 600, 800, 900, 1000, up to 1200Ω.

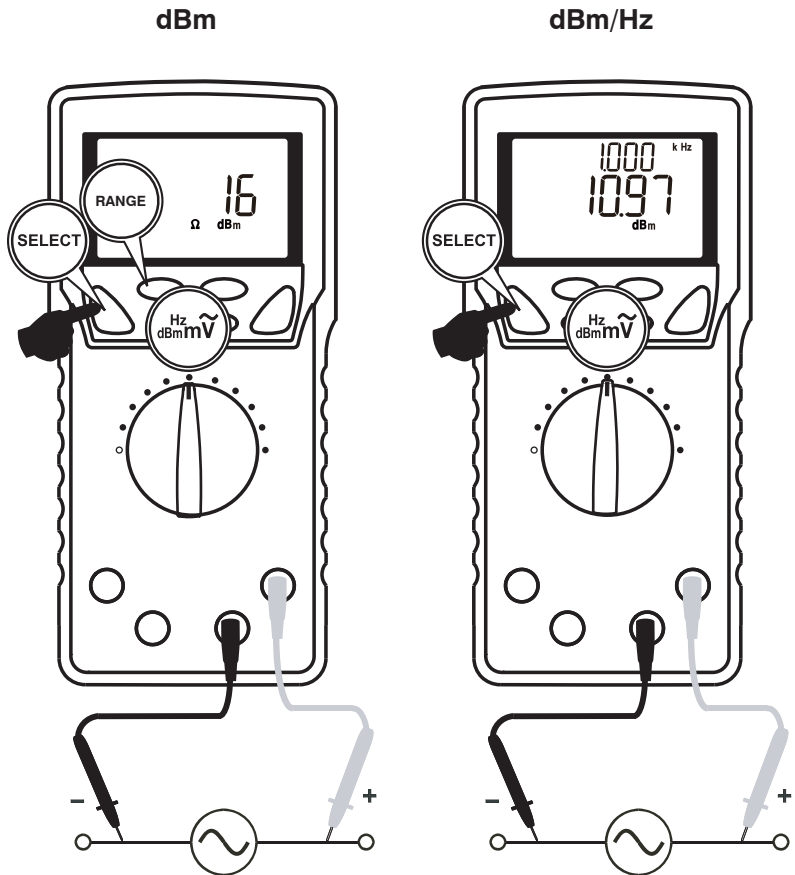

Note:

Range	Frequency measurement (Hz) Input sensitivity (Sine wave)	Frequency range
500.00mVac	100mV	10.00Hz ~ 200.0kHz

- The display style of [mV̂/Hz] shows the bar graph.
- As a normal condition, non-connected test leads may cause unstable readings.
- Manual trigger level selection on Hz reading is not available in this function.

5-7 [Ω^{nS})] (Do not apply any voltage or current.)

- **Resistance (Ω) measurement**
- **Conductance (nS) measurement**
- **Continuity check (•))]**

⚠ WARNING

Do not apply any voltage or current to the measuring terminals.

⚠ CAUTION

In the case of high resistance measurement, readings may be unstable due to external inductive influence.

1) What to measure

- Ω(Resistance): Resistor, circuit resistance, etc.
- •))](Continuity check): Wiring connections, Operation of switches, etc.
- nS(Conductance): High-value resistance of Giga-Ohms for leakage measurements

Note: Conductance is the inverse of Resistance, that is $S=1/\Omega$ or $nS=1/G\Omega$.

2) Measuring ranges

- Ω: 6 ranges; 500.00Ω, 5.0000kΩ, 50.000kΩ, 500.00kΩ, 5.0000MΩ, and 50.000MΩ
- •))]: Beeper threshold level: between 20Ω and 200Ω, Response time: <100μs
- nS : 99.99nS (Single range)

*Open circuit voltage between the measuring terminals: <1.3V dc (<3V dc for 500.00Ω range)

3) Measuring procedure

- ① Connect the red plug of the test lead to Ω measuring terminal and the black one to the **COM** terminal.
- ② Set the function selector to Ω .
- ③ Press the **SELECT** button to select a function you want to perform.
- ④ Apply the test pins (Red and Black) to the object to measure.
- ⑤ Read the display.

(•••): A continuous beep tone indicates a complete wire.)

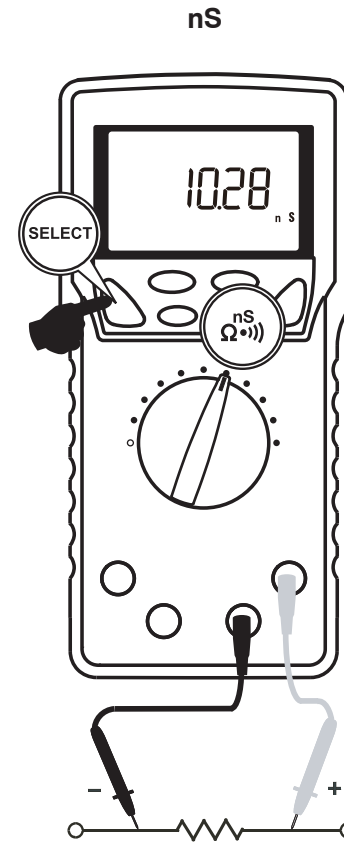
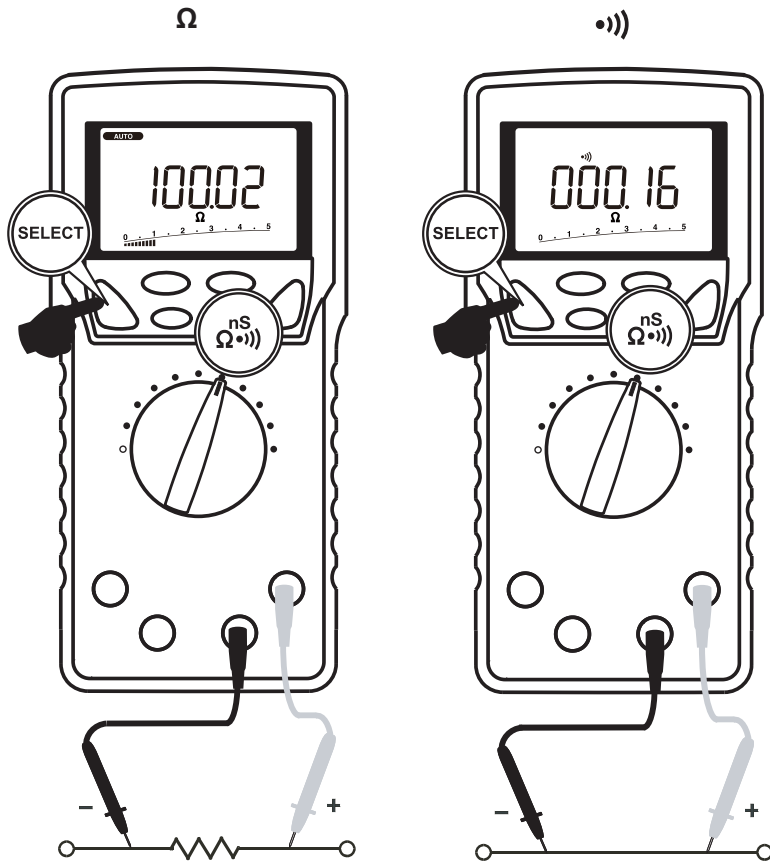

Note:

- [nS] function does not show the bar graph.
- To avoid external noise influence, shield the object to measure with COM potential. Measurements with finger-touched test pins may cause some errors being influenced by human body conductance.

5-8 [Temp] (Max. rated input voltage: 50mV dc)

- Temperature measurement (°C) or (°F)
(For K-type thermocouple)

⚠ WARNING

1. Pay attention in order to avoid risk of burn depending on the object temperature or measuring environment.
2. Do not apply exceeding 50mV to the measuring terminals.

- 1) What to measure
°C , °F (Temperature): Temperature of liquid, solids, gas, and etc.
- 2) Measuring ranges
Celsius: -50.0°C ~ 1000.0°C
Fahrenheit: -58.0°F ~ to 1832.0 °F
- 3) Measuring procedure
 - ① Connect the provided K-type thermocouple to the **Temp** measuring terminals.
 - ② Set the function selector to **Temp**.
 - ③ Press the **SELECT** button to select °C or °F.
 - ④ Apply the thermocouple to the object to measure.
 - ⑤ Read the display.

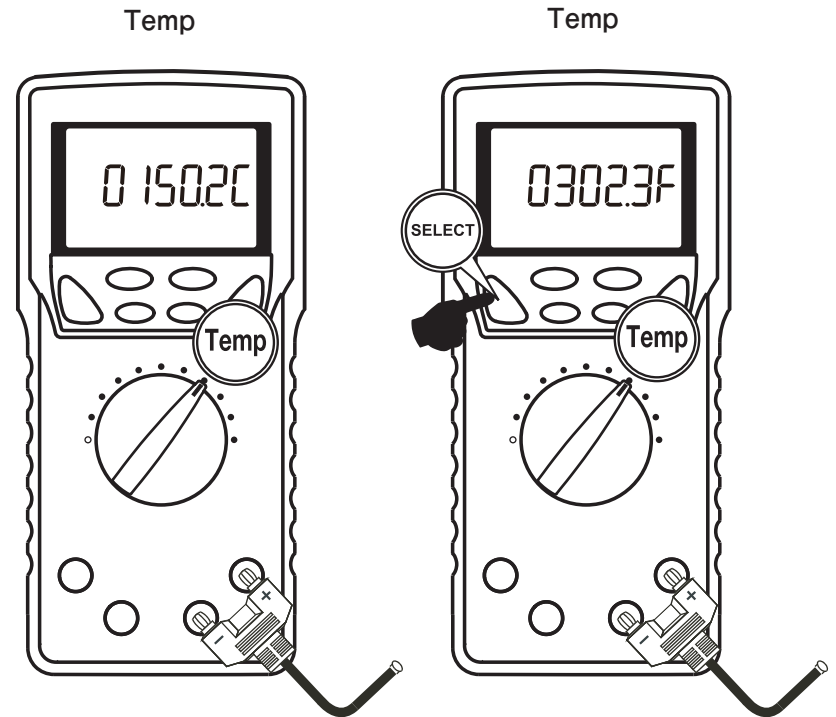

Note:

- Temperature function does not show the bar graph.
- The provided K-type thermocouple (K-250PC) is a polar device. Connect the device to the meter properly.
- The range of K-250PC is -50 °C to 250 °C .
- Separately available K-type adapter (K-AD) allows you to use other international standard mini plug thermocouples.

5-9 $\left[\begin{array}{c} \text{---} \\ | \\ \text{---} \end{array} \right] \rightarrow \left[\begin{array}{c} \text{---} \\ | \\ \text{---} \end{array} \right]$ (Do not apply any voltage or current.)

- Capacitance ($\begin{array}{c} \text{---} \\ | \\ \text{---} \end{array}$) measurement
- Diode ($\begin{array}{c} \text{---} \\ | \\ \text{---} \end{array} \rightarrow \begin{array}{c} \text{---} \\ | \\ \text{---} \end{array}$) test

\triangle WARNING

1. Do not apply any voltage or current to the measuring terminals.
2. Measuring live circuit may damage the meter.

5-9-1 Capacitance ($\begin{array}{c} \text{---} \\ | \\ \text{---} \end{array}$) measurement

\triangle CAUTION

1. Discharge the capacitor before any measurement.
2. The instrument applies the current to the capacitor to measure.
Capacitors with large leakage such as chemical capacitors cannot be measured accurately.

1) What to measure

$\begin{array}{c} \text{---} \\ | \\ \text{---} \end{array}$ (Capacitance): Capacitance of capacitors

2) Measuring ranges

$\begin{array}{c} \text{---} \\ | \\ \text{---} \end{array}$: 7 ranges; 50.00nF, 500.0nF, 5.000 μ F, 50.00 μ F, 500.0 μ F, 5.000mF, and 25.00mF

3) Measuring procedure

- ① Connect the red plug of the test lead to $\begin{array}{c} \text{---} \\ | \\ \text{---} \end{array}$ measuring terminal and the black one to the **COM** terminal.
- ② Set the function selector to $\begin{array}{c} \text{---} \\ | \\ \text{---} \end{array} \rightarrow \begin{array}{c} \text{---} \\ | \\ \text{---} \end{array}$, then press the **SELECT** button to select the capacitance measurement. (Unit "F" will be indicated.)
- ③ Apply the test pins (Red and Black) to the object to measure.
- ④ Read the display.

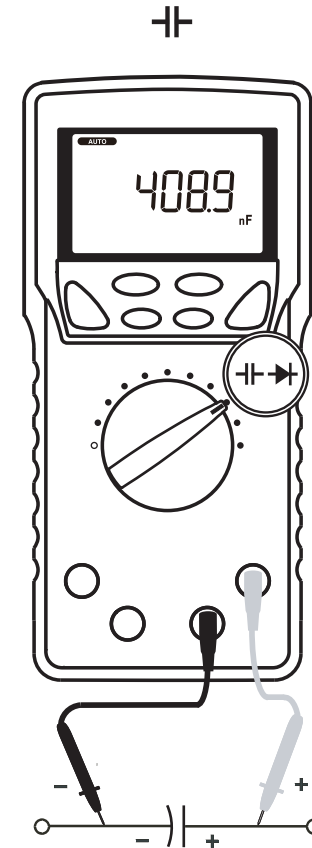

Note:

- Capacitance function does not show the bar graph.

5-9-2 Diode (→|←) test

1) What to measure

→|← (Diode test): Judging the diode (Good or defective)

2) Measuring procedure

- ① Connect the red plug of the test lead to →|← measuring terminal and the black one to the **COM** terminal.
- ② Set the function selector to →|←, then press the **SELECT** button to select the diode test.
(The sub display shows [**diode**].)
- ③ Apply the black test pin to the cathode of the diode, and the red one to the anode.
- ④ The display will show the forward voltage drop (forward biased).

*Forward biased voltage drop for a good silicon diode is between 0.400V to 0.900V. A reading higher than that indicates a defective diode. A zero (or close to) reading indicates a defective diode (shorted). An **OL** indicates a defective diode (open).

- ⑤ Apply the red test pin to the cathode of the diode, and the black one to the anode.

*A reading [**OL**] for reverse biased voltage drop indicates the diode is good. Any other readings indicate the diode is defective (resistive or shorted).

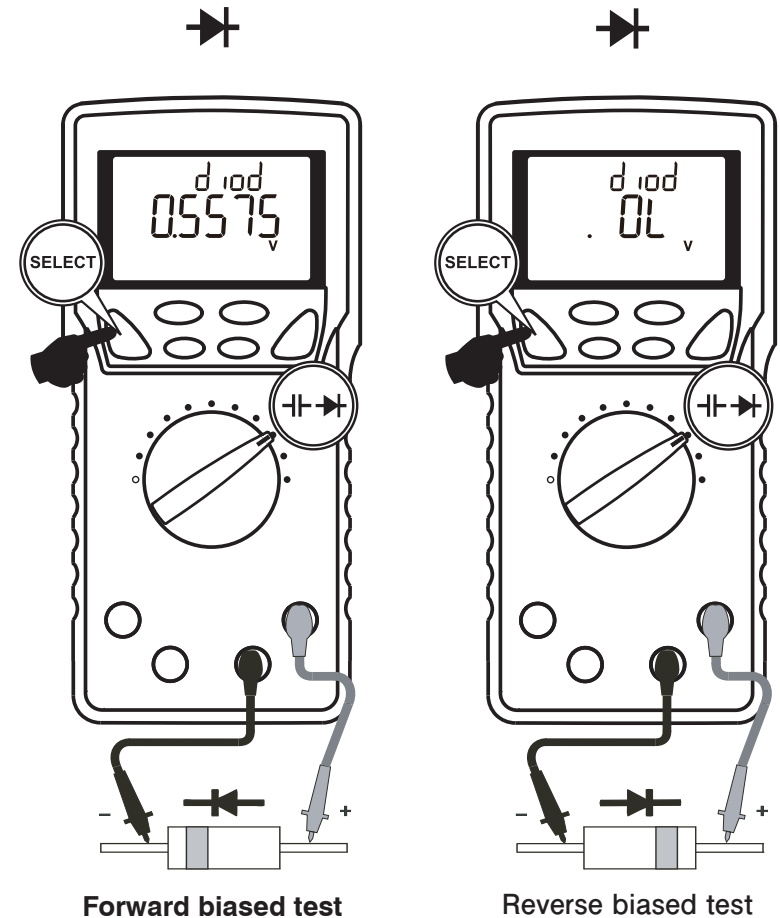

Note:

- Open circuit voltage between the measuring terminals: <3.5V dc
- Test current: 0.4mA (typical)
- Diode test function does not show the bar graph.

5-10 $\left[\frac{\%4 \sim 20\text{mA}}{\text{mA} \sim \text{Hz}} \right]$, $\left[\frac{\mu\text{A} \sim \text{Hz}}{\mu\text{A} \sim \text{Hz}} \right]$

- DC current (mA, μA, A) measurement
- AC current (mA, μA, A)/Frequency(Hz) simultaneous measurement
- DC current (mA, μA, A)/AC current (mA, μA, A) simultaneous measurement
- DC+AC current (mA, μA, A)/AC current (mA, μA, A) simultaneous measurement
- %4 ~ 20mA measurement

⚠ WARNING

1. Do not apply any voltage to the measuring terminals.
2. Be sure to connect the meter in series with the load object.
3. Do not apply any input exceeding the max. rated current.
4. First turn off the circuit to measure, then cut the part. Connect the test leads of the meter properly in series with the circuit.

Correct way

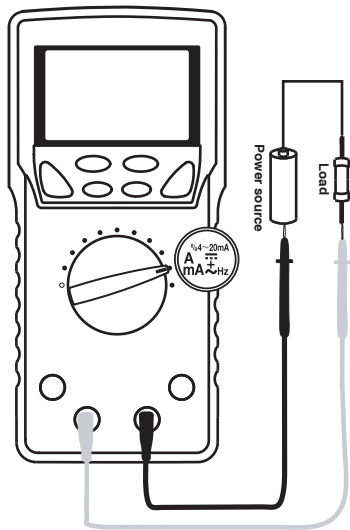

Wrong way

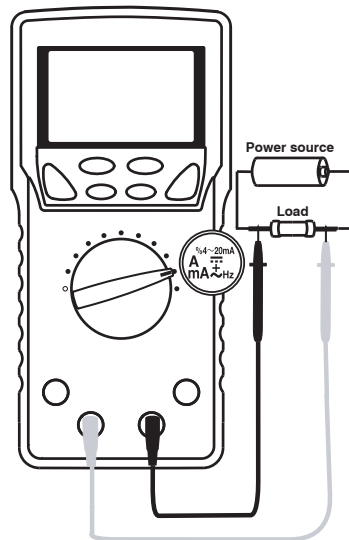

5-10-1 Current (mA/μA)/%4 ~ 20mA measurement

(mA, mĀ, mA, μA, μĀ, μA Max. rated input current 500mA dc/ac)

- 1) What to measure
 - mA/%4 ~ 20mA: Instrumentation loop current
 - mA, μA (DC current): DC circuit current
 - mĀ, μĀ (AC current): AC circuit current
 - mA/mĀ, μA/μĀ (DC current component/AC current component)
 - mA/mĀ, μA/μĀ (DC/AC superimposed signal current/AC current component)
 - Hz (Frequency): Measuring current frequency

2) Measuring ranges

mA : 50.000mA and 500.00mA
μA : 500.00μA and 5000.0μA

3) Measuring procedure

- ① Set the function selector to $\frac{\%4 \sim 20\text{mA}}{\text{mA} \sim \text{Hz}}$ or $\frac{\mu\text{A} \sim \text{Hz}}{\mu\text{A} \sim \text{Hz}}$, then press the **SELECT** button to select [mA/%4 ~ 20mA], [mA/mĀ], [mA/mĀ], [mA/Hz] for mA range, or select [μA], [μA/μĀ], [μA/μĀ], [μA/Hz] for μA range.
- ② Connect the red plug of the test lead to **mA μA** measuring terminal and the black one to the **COM** terminal.
- ③ Connect the test pins (red and black) in series with the circuit to measure.
 - mA, μA : Connect the black test pin to the lower electric potential side of the circuit to measure, and the red test pin to the higher electric potential side in series with the object.
 - mA/mĀ, μA/μĀ : Connect the test pins (red and black) in series with the circuit to measure.
- ④ Read the display.

$m\bar{A}/\%4 \sim 20mA$

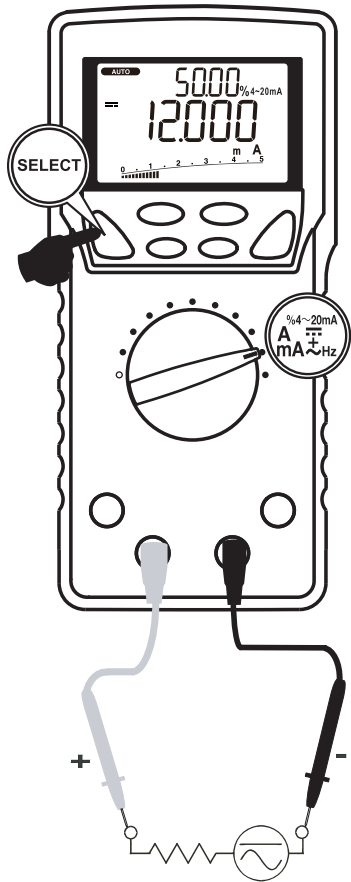

$m\bar{A} / m\tilde{A}$

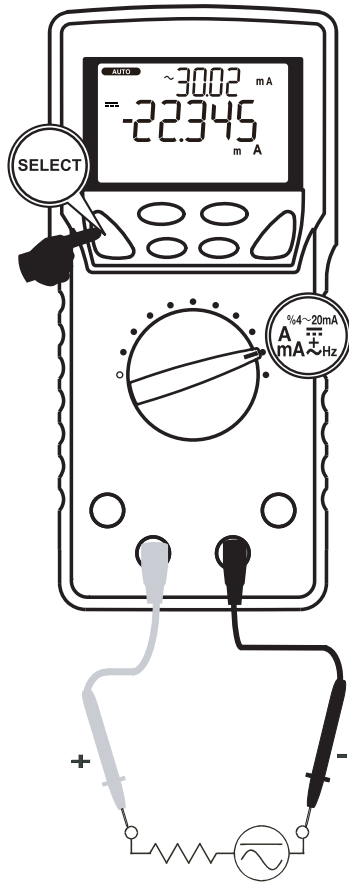

$m\tilde{A} / m\tilde{A}$

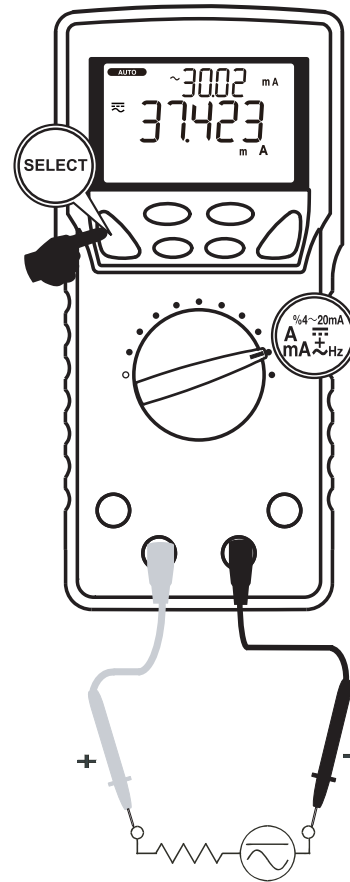

$m\tilde{A} / Hz$

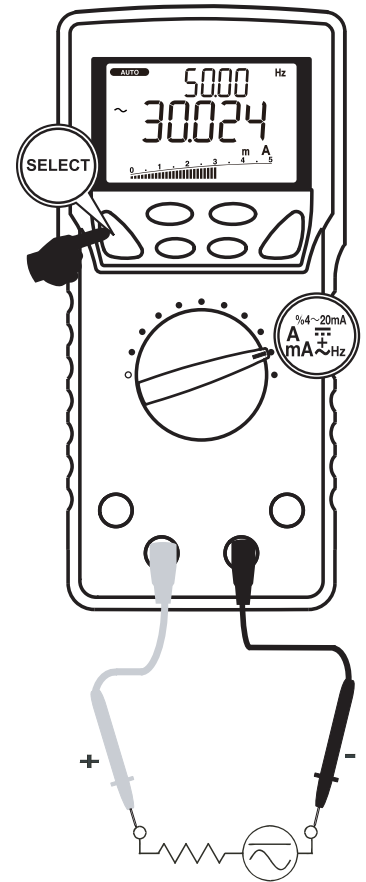

Note:

In the $\%4 \sim 20mA$ measurement, loop-current percentage is indicated, being set at $4mA=0\%$ and $20mA=100\%$.

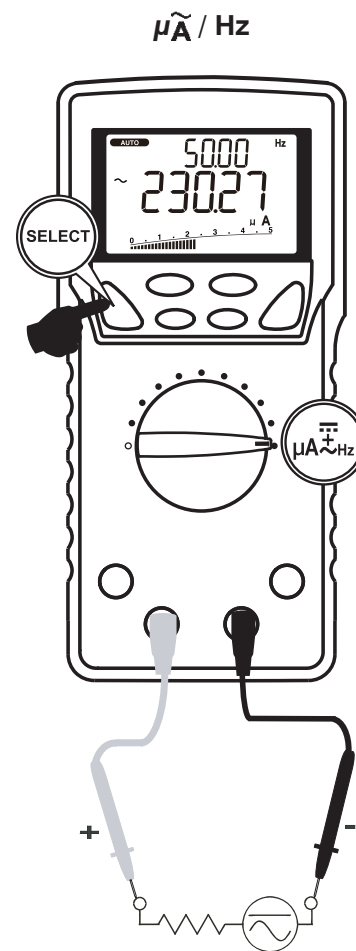
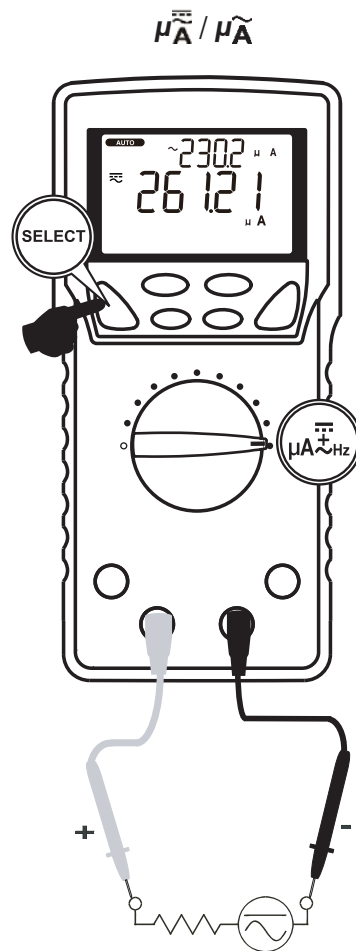
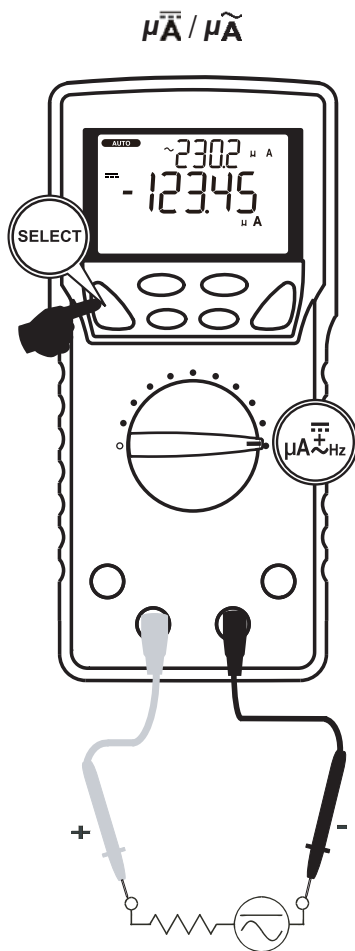
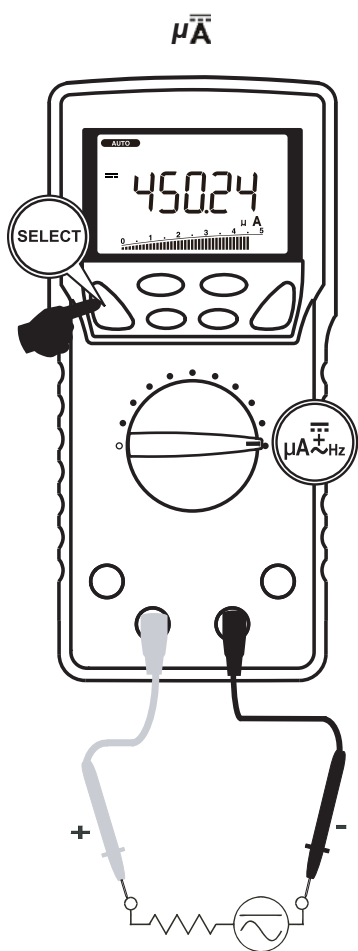

Note:

Measuring Range	Frequency (Hz) Input sensitivity(Sine wave)	Frequency range
500.00μA	50μA	10.00Hz ~ 10.00kHz
5000.0μA	500μA	
50.000mA	5mA	
500.00mA	50mA	

5-10-2 Current (A) measurement

($\overline{\overline{\text{A}}}$, $\overline{\sim\text{A}}$, $\overline{\overline{\text{A}}}$ Max. rated input current AC 10A dc/ac)

1) What to measure

- $\overline{\overline{\text{A}}}$ (DC current): DC circuit current
- $\overline{\sim\text{A}}$ (AC current): AC circuit current
- $\overline{\overline{\text{A}}}$ / $\overline{\sim\text{A}}$ (DC current component / AC current component)
- $\overline{\overline{\text{A}}}$ / $\overline{\sim\text{A}}$ (DC/AC superimposed signal current / AC current component)
- Hz (Frequency): Measuring current frequency

2) Measuring ranges

5.0000A and 10.000A

3) Measuring procedure

- ① Set the function selector to $\overline{\overline{\text{A}}}$, $\overline{\sim\text{A}}$, $\overline{\overline{\text{A}}}$ / $\overline{\sim\text{A}}$, or $\overline{\sim\text{A}}$ / Hz, and press the **SELECT** button to select a display style from [$\overline{\overline{\text{A}}}$], [$\overline{\overline{\text{A}}}$ / $\overline{\sim\text{A}}$], [$\overline{\sim\text{A}}$ / $\overline{\overline{\text{A}}}$], and [$\overline{\sim\text{A}}$ / Hz].
- ② Connect the red plug of the test lead to **A** measuring terminal and the black one to the **COM** terminal.
- ③ Connect the test pins (red and black) in series with the circuit to measure.
 - $\overline{\overline{\text{A}}}$: Connect the black test pin to the lower electric potential side of the circuit to measure, and the red test pin to the higher electric potential side in series with the object.
 - $\overline{\sim\text{A}}$, $\overline{\overline{\text{A}}}$: Connect the test pins (red and black) in series with the circuit to measure.
- ④ Read the display.

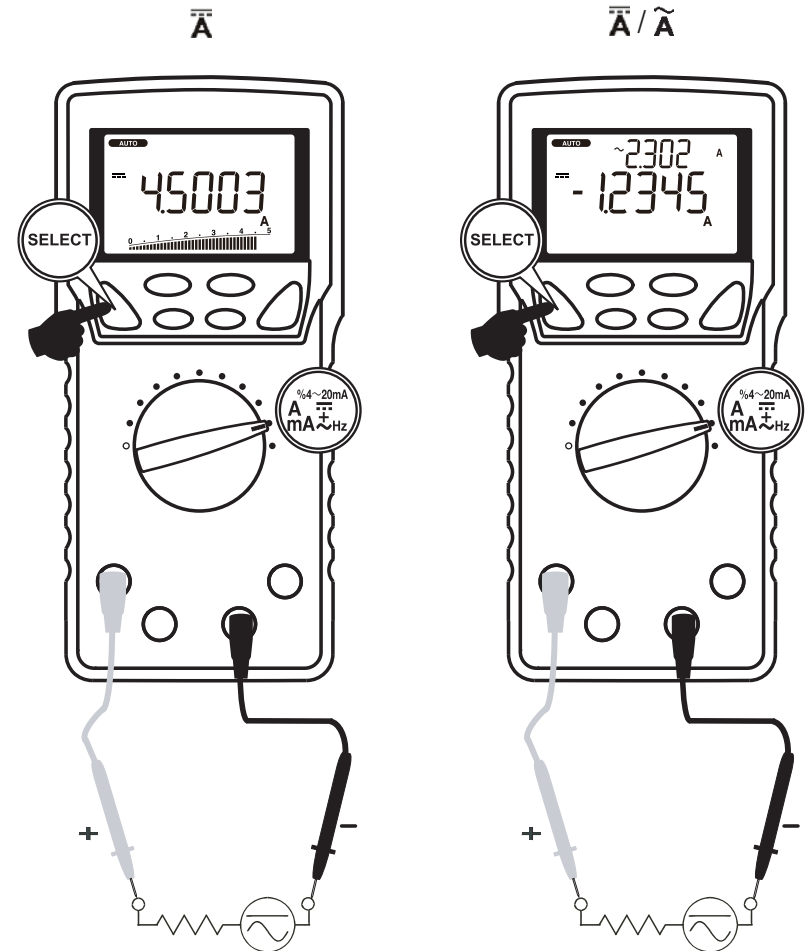

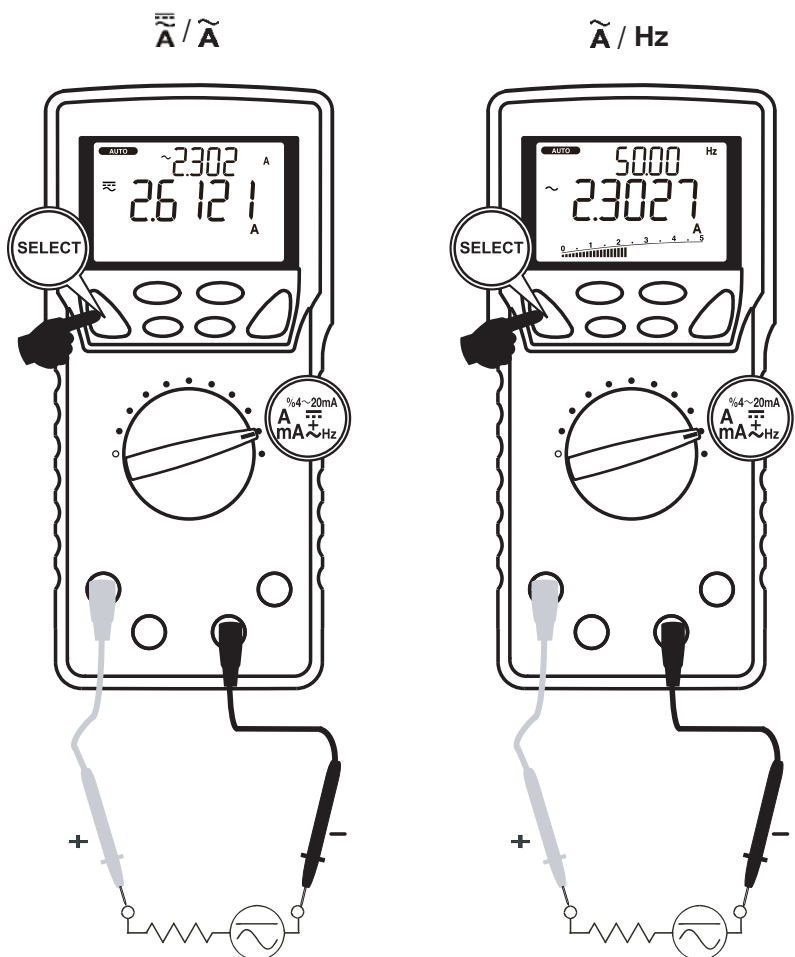

Note:

- > 6A: Cool down more than 3 minutes after measuring 1 minute.
- < 6A Continuable

Measuring range	Frequency (Hz) Input sensitivity (Sine wave)	Frequency range
5.0000A	1A	10.00Hz ~ 3.000kHz
10.000A	8A	

5-11 Measurements with Optional Products

⚠ WARNING

1. Do not apply any input exceeding max. rated input for the separately available accessories.
2. Do not switch the function selector while measuring.

⚠ CAUTION

To make measurements of consumption current for home appliances using a current probe, use a line separator as shown in the drawing below.

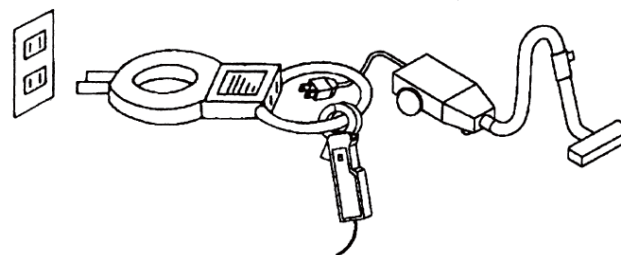

**5-11-1 Clamp probe: CL-20D
(Max. measurable current 200A ac)**

- 1) What to measure
50/60 Hz sine wave current such as consumption current of home appliances, current of power supply equipments, and etc.
- 2) Measuring ranges
20A and 200A
- 3) Measuring procedure

- ① Connect the red plug of the current probe to the **V** measuring terminal and the black one to the **COM** terminal.
- ② Set the function selector to $\overset{\text{Hz}}{\text{dBm}}\tilde{\text{V}}$, then press the **SELECT** button to select [$\tilde{\text{V}}/\text{Hz}$].
- ③ Press the **RANGE** button to set the 5.0000V range.
- ④ Set the range selector knob on the current probe to the 20A range or 200A range.
- ⑤ Open the clamp jaws of the clamp probe and clamp the wire to measure.
- ⑥ Multiply the reading by 10 for 20A range, and by 100 for 200A range.

Note:

- Current exceeding 20A or 200A cannot be measured. (Do not measure such high current even though the display works.)
- Try to put the wire to measure in the center of the clamp jaws as possible.

5-11-2 Clamp probe: CL-22AD
(Max. measurable current 200A dc/ac)

- 1) What to measure
ACA: 50/60 Hz sine wave current such as consumption current of home appliances, current of power supply equipments, and etc.
DCA: Current of automotive electric circuits, consumption current of DC equipments, etc.
- 2) Measuring ranges
20A and 200A
- 3) Measuring procedure
 - ① Connect the red plug of the current probe to the **V** measuring terminal and the black one to the **COM** terminal.
 - ② To make DC current measurement (DCA), set the function selector to $\overset{\text{D}}{\mu\text{Hz}}\overline{\text{mV}}$ and press the **SELECT** button to select

[$\overline{\text{mV}}$]. The 500.00mV range will be set.
To make AC current measurement (ACA), set the function selector to $\overset{\text{Hz}}{\text{dBm}}\tilde{\text{mV}}$ and press the **SELECT** button to select [$\text{m}\tilde{\text{V}}/\text{Hz}$]. The 500.00mV range will be set.

- ③ Set the range selector knob on the current probe to the 20A range or 200A range.
*Before making DC current measurement, turn the Center Adjuster knob to make the reading zero.
- ④ Open the clamp jaws of the clamp probe and clamp the wire to measure.
- ⑤ Multiply the reading by 0.1 for 20A range, and read the display directly for 200A range.

Note:

- Current exceeding 20A or 200A cannot be measured. (Do not measure such high current even though the display works.)
- Try to put the wire to measure in the center of the clamp jaws as possible.

5-11-3 DC Clamp probe: CL-33D
(Max. measurable current 300A dc)

- 1) What to measure
Current of automotive electric circuits, consumption current of DC equipments, etc.
- 2) Measuring ranges
30A and 300A
- 3) Measuring procedure
 - ① Connect the red plug of the current probe to the **V** measuring terminal and the black one to the **COM** terminal.
 - ② Set the function selector to $\overset{\text{D}}{\mu\text{Hz}}\overline{\text{mV}}$ and press the **SELECT** button to select [$\overline{\text{mV}}$]. The 500.00mV range will be set.

- ③ Set the range selector knob on the current probe to the 30A range or 300A range.

*Before making DC current measurement, turn the Center Adjuster knob to make the reading zero.

- ④ Open the clamp jaws of the clamp probe and clamp the wire to measure.
- ⑤ Multiply the reading by 0.1 for 30A range, and read the display directly for 300A range.

Note:

- Current exceeding 30A or 300A cannot be measured.
(Do not measure such high current even though the display works.)
- Try to put the wire to measure in the center of the clamp jaws as possible.

5-11-4 Temperature probe: T-300PC

1) What to measure

Temperature of liquid, solids, gas, and etc.

Note:

To make temperature measurement, connect the temperature probe to the **PC7000** connected to the PC on which sanwa's software PC Link7 is installed and running.

2) Measuring range

-50 ~ 300°C

DMM range: 5kΩ

3) Measuring procedure

- ① Connect the red plug of the temperature probe to Ω^{NS} measuring terminal and the black one to the **COM** terminal.
- ② Set the function selector to Ω^{NS} and press the **SELECT** button to select [Ω].
- ③ Press the **RANGE HOLD** button to set 5kΩ.
- ④ Apply the thermocouple to the object to measure.
- ⑤ Read the measurements on the information window of the PC Link7.
- ⑥ Remove the thermocouple from the object.

[6] MAINTENANCE

⚠ WARNING

1. The followings are important to safety. Read this manual thoroughly to maintain the instrument.
2. Calibrate and inspect the instrument at least once a year to ensure safety and maintain its accuracy.

6-1 Simple Examination

1) Appearance

- Check for damaged appearance by dropping down and so on.

2) Test leads

- Check for loose contacts between the measuring terminals and test lead plugs.
- Check for damaged test lead wires.
- Check for exposed core wire anywhere on the test leads.

If you find any problem on the above items, stop using immediately and ask us to repair it.

Check for the test leads without breaking wires, referring to the section 5-1.

6-2 Calibration

If self-diagnostic message “rE-O” is being displayed while powering on, the meter is re-organizing internal parameters. Do not turn off the meter, and it will be back to normal measurement shortly. However, if self-diagnostic message “C_Er” is being displayed while powering on, some meter ranges might be largely out of specifications. To avoid misleading measurements, stop using the meter and send it for re-calibration. Refer to the AFTER-SALE SERVICE section for obtaining warranty or repairing service.

For requesting calibration and inspection, contact an authorized agent/distribution service provider, listed in our website. See section 7-3.

6-3 Battery and Fuse Replacement

⚠ WARNING

1. Do not open the rear case with live measuring terminals to avoid electric shock. Also, make sure the meter power is OFF, before starting replacement.
2. Be sure to use the specified fuse. Neither use unspecified fuse nor short-circuit the fuse holder.

Pre-installed battery

Since the pre-installed battery is for monitoring, it may not be durable as typically expected.

*The purpose of the battery for monitoring is to check for the functions and performances of the product.

Replacement procedure

- ① Remove the holster and loosen the Philips-head screw fixing the battery door using appropriate screw driver.
- ② Remove the battery door and replace the battery or fuse with new one.
- ③ Re-fasten the screw and set the holster again.

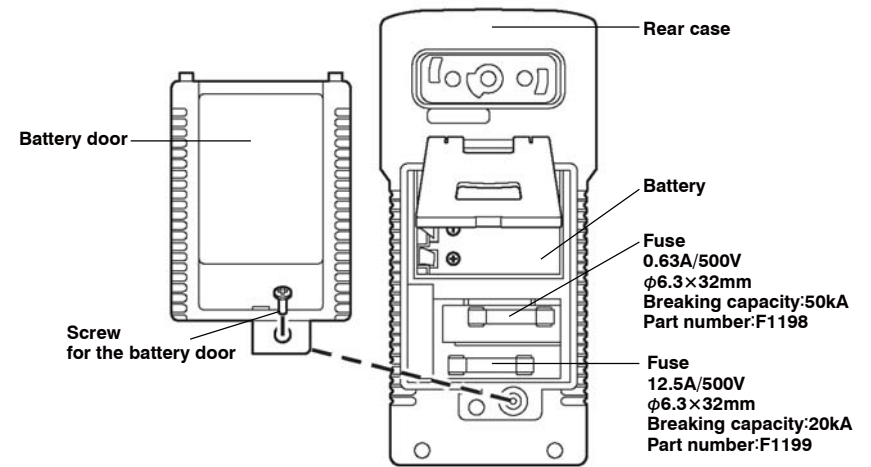

6-4 Storage

⚠ CAUTION

1. The panel and case are not resistant to volatile solvents. Do not wipe out with solvents or isopropyl alcohol. Clean the instrument up with a dry soft cloth.
2. The panel and case are not resistant to heat. Keep it away from heat-generating devices such as solder irons.
3. Do not save the instrument into vibratory places or where the instrument may fall off.
4. Do not expose the instrument to direct sunlight and do not save it into any places with extreme temperature, humid, or condensation.
5. Remove the battery for saving the instrument over a long period of time.

Save the instrument into an appropriate place, according to the precautions above.

[7] AFTER-SALE SERVICE

7-1 Warranty and Provision

Sanwa offers comprehensive warranty services to its end-users and to its product resellers. Under Sanwa's general warranty policy, each instrument is warranted to be free from defects in workmanship or material under normal use for the period of one (1) year from the date of purchase.

This warranty policy is valid within the country of purchase only, and applied only to the product purchased from Sanwa authorized agent or distributor.

Sanwa reserves the right to inspect all warranty claims to determine the extent to which the warranty policy shall apply. This warranty shall not apply to disposables batteries, or any product or parts, which have been subject to one of the following causes:

1. A failure due to improper handling or use that deviates from the instruction manual.
2. A failure due to inadequate repair or modification by people other than Sanwa service personnel.
3. A failure due to causes not attributable to this product such as fire, flood and other natural disaster.
4. Non-operation due to a discharged battery.
5. A failure or damage due to transportation, relocation or dropping after the purchase.

7-2 Repair

Customers are asked to provide the following information when requesting services:

1. Customer name, address, and contact information
2. Description of problem
3. Description of product configuration
4. Model Number
5. Product Serial Number
6. Proof of Date-of-Purchase
7. Where you purchased the product

Please contact Sanwa authorized agent / distributor / service

provider, listed in our website, in your country with above information. An instrument sent to Sanwa / agent / distributor without above information will be returned to the customer.

Note:

- 1) Prior to requesting repair, please check the following:
Capacity of the built-in battery, polarity of installation and discontinuity of the test leads.
- 2) Repair during the warranty period:
The failed meter will be repaired in accordance with the conditions stipulated in 7-1 Warranty and Provision.
- 3) Repair after the warranty period has expired:
In some cases, repair and transportation cost may become higher than the price of the product. Please contact Sanwa authorized agent / service provider in advance.
The minimum retention period of service functional parts is 6 years after the discontinuation of manufacture. This retention period is the repair warranty period. Please note, however, if such functional parts become unavailable for reasons of discontinuation of manufacture, etc., the retention period may become shorter accordingly.
- 4) Precautions when sending the product to be repaired:
To ensure the safety of the product during transportation, place the product in a box that is larger than the product 5 times or more in volume and fill cushion materials fully and then clearly mark "Repair Product Enclosed" on the box surface. The cost of sending and returning the product shall be borne by the customer.

7-3 SANWA web site

<http://www.sanwa-meter.co.jp>

E-mail: exp_sales@sanwa-meter.co.jp

[8] SPECIFICATIONS

8-1 General Specifications

Operation method	Delta-sigma modulation	
LCD display	Main display	50,000 counts: DCV, DCmV, ACV, ACmV, DCA, DCmA, DC μ A, ACA, ACmA, AC μ A, Resistance, Continuity 500,000 counts: DCV, DCmV 99,999 counts: Logic-Level Frequency (Hz) 20,000 counts: Diode 12,500 counts: Temperature (°C) 22,820 counts: Temperature(°F) 9,999 counts: nS, dBm, Duty Cycle 5,000 counts: Capacitance Bar graph: Up to 41 segments
	Sub display	5,000 counts: ACV, ACmV, ACA, ACmA, AC μ A 9,999 counts: Frequency (Hz), Loop-current %4 ~ 20mA
Over-range indication	Over-range input turns on "OL" indicator at the numeric part.	
Sampling rate	Numeric part	5 times / sec. (50,000-count mode) 1.25 times/sec. (500,000-count mode)
	Bar graph part	60 times / sec.
Low battery indication	Decreasing the internal battery voltage to approx. 7V turns the battery mark on.	
Operating conditions	Altitude: < 2,000m Pollution degree: II	
Operating temperature/humidity	5°C to 40°C : non-condensing 5°C to 31°C : 80%RH (Max.) 31°C to 40°C : decreasing 80% to 50% linearly	
Storage temperature/humidity	-10°C to 40°C : 80%RH (Max.) non-condensing (with battery removed) 40°C to 50°C : 70%RH (Max.) non-condensing (Remove the battery, if the equipment is not going to be used for a long time.)	
Temperature coefficient	0.15 x (accuracy @23±5°C) / °C @(0°C to 18°C or 28°C to 40°C)	
Power source	Single alkaline 9V battery 6LR61 (IEC6LF22, NEDA1604A)	
AC sensing method	True RMS (AC coupling)	

Auto Power Saving	Approx. 17 minutes after the last operation				
Safety Compliances	IEC61010-1:2001 IEC61010-031:2008				
		Category II for 1000V ac and dc Category III for 600V ac and dc			
	mA μ A	Category II for 500V ac and dc Category III for 300V ac and dc			
EMC	Meets EN61326-1:2006 In an RF field of 3V/m: Capacitance function is not specified Other function ranges: Total Accuracy = \pm (Specified% rdg + 1000digits) Performance above 3V/m is not specified				
	Dimensions	<table border="1"> <tr> <td>without holster</td> <td>Approx. L175mm×W80mm×H40mm</td> </tr> <tr> <td>with holster</td> <td>Approx. L184mm×W86mm×H52mm</td> </tr> </table>	without holster	Approx. L175mm×W80mm×H40mm	with holster
without holster	Approx. L175mm×W80mm×H40mm				
with holster	Approx. L184mm×W86mm×H52mm				
Weight	without holster	Approx. 360g			
	with holster	Approx. 430g			
Power consumption	Approx. 58mW / Approx. 72mW with LPF in use Approx. 0.63mW (Auto Power Saving)				
Battery life	Approx. 100hours (DCV measurement)				
Accessories	Test leads (TL-23a), Holster (H-700) with light shielding magnet cap, K-type thermocouple (K-250PC), Instruction manual				

OVERVOLTAGE CATEGORY

- Equipment of CAT I: Secondary cable runs from a power supply transformer connected to a wall socket.
- Equipment of CAT II: Primary cable runs of power-consuming equipments from a wall socket.
- Equipment of CAT III: Primary cable runs of equipments directly connected to a distribution board and cable runs from a distribution board to wall sockets.
- Equipment of CAT IV: Cable runs from an incoming line to a distribution board.

8-2 Measuring Range and Accuracy

Accuracy: $\pm(\% \text{ rdg} + \text{dgt})$

rdg: reading, dgt: least significant digit

Temperature: $23^{\circ}\text{C} \pm 5^{\circ}\text{C}$, Humidity: $<75\%$ R.H.

True RMS voltage and current accuracies are specified from 10% to 100% of each range otherwise specified.

Crest factor: $<2:1$ (at full scale), $<4:1$ (at half scale)

DC Voltage DCV

DC voltage for single display

Range	Accuracy*
500.00 mV 5.0000V	$\pm (0.03\% \text{ rdg} + 2\text{dgt})$
50.000 mV	$\pm (0.04\% \text{ rdg} + 2\text{dgt})$
500.00V	$\pm (0.05\% \text{ rdg} + 2\text{dgt})$
1000.0V	$\pm (0.15\% \text{ rdg} + 2\text{dgt})$

Input impedance: $10\text{M}\Omega$, 60pF nominal
(80pF nominal for 500.00mV range)

* Accuracy in the 50000-count display mode
Accuracy in the 500000-count display mode is as follows.
 $\pm(\text{Specified \% of rdg} + 20\text{dgt})$

DC Voltage/AC Voltage for dual display

Range	Accuracy
500.00mV 5.0000V 50.000V 500.00V 1000.0V	Main display : $\pm (0.7\% \text{ rdg} + 60\text{dgt})$

Input impedance: $10\text{M}\Omega$, 60pF nominal
(80pF nominal for 500.00mV range)

Residual reading: Less than 50 digits with test leads shorted.

AC Voltage ACV and DC+AC Voltage DC+AC V

AC voltage/ Frequency for dual display

Range	Accuracy*
45Hz ~ 65Hz	
500.00mV 5.0000V 50.000V 500.00V 1000.0V	$\pm (0.5\% \text{ rdg} + 40\text{dgt})$
65Hz ~ 500Hz	
500.00mV	$\pm (0.8\% \text{ rdg} + 40\text{dgt})$
5.0000V 50.000V 500.00V	$\pm (1.0\% \text{ rdg} + 50\text{dgt})$
1000.0V	$\pm (1.5\% \text{ rdg} + 50\text{dgt})$
500Hz ~ 1kHz	
500.00mV	$\pm (0.8\% \text{ rdg} + 40\text{dgt})$
5.0000V 50.000V 500.00V 1000.0V	$\pm (1.5\% \text{ rdg} + 60\text{dgt})$
1kHz ~ 20kHz	
500.00mV	$\pm 1\text{dB}^{**}$
5.0000V 50.000V	$\pm 2\text{dB}^{**}$
500.00V	$\pm 3\text{dB}^{**}$
1000.0V	Unspecified

Input impedance: $10\text{M}\Omega$, 60pF nominal
(80pF nominal for 500.00mV range)

Residual reading: Less than 50 digits with test leads shorted.

* From 5% to 10% of the range: $\pm(\text{Specified \% of rdg} + 80\text{dgt})$

** From 5% to 10% of the range: $\pm(\text{Specified \% of rdg} + 180\text{dgt})$
From 10% to 15% of the range: $\pm(\text{Specified \% of rdg} + 100\text{dgt})$

DC Voltage/AC Voltage, DC+AC Voltage/AC Voltage for dual display

Range	Accuracy*
DC, 45Hz ~ 65Hz	
500.00mV 5.0000V 50.000V 500.00V 1000.0V	Main display: ± (0.7% rdg + 60dgt) Sub display: ± (0.7% rdg + 6dgt)
65Hz ~ 500Hz	
500.00mV	Main display: ± (1.0% rdg + 40dgt) Sub display: ± (1.0% rdg + 4dgt)
5.0000V 50.000V 500.00V	Main display: ± (1.2% rdg + 60dgt) Sub display: ± (1.2% rdg + 6dgt)
1000.0V	Main display: ± (1.7% rdg + 60dgt) Sub display: ± (1.7% rdg + 6dgt)
500Hz ~ 1kHz	
500.00mV	Main display: ± (1.0% rdg + 40dgt) Sub display: ± (1.0% rdg + 4dgt)
5.0000V 50.000V 500.00V 1000.0V	Main display: ± (1.7% rdg + 60dgt) Sub display: ± (1.7% rdg + 6dgt)
1kHz ~ 20kHz	
500.00mV	±1dB**
5.0000V 50.000V	±2dB**
500.00V	±3dB**
1000.0V	Unspecified

Input impedance: 10MΩ, 60pF nominal

(80pF nominal for 500.00mV range)

Residual reading: Less than 50 digits with test leads shorted.

* From 5% to 10% of the range: ±(Specified % of rdg + 80dgt)

** From 5% to 10% of the range: ±(Specified % of rdg + 180dgt)
From 10% to 15% of the range: ±(Specified % of rdg + 100dgt)

AC Voltage (with low-pass filter for Variable Frequency Drive)

Range	Accuracy*
10Hz ~ 40Hz	
5.0000V 50.000V 500.00V 1000.0V	± (3.5% rdg + 80dgt)
40Hz ~ 200Hz	
5.0000V 50.000V 500.00V 1000.0V	± (2.0% rdg + 60dgt)
200Hz ~ 440Hz	
5.0000V 50.000V 500.00V 1000.0V	± (7.0% rdg + 80dgt)**

*Not specified for fundamental frequency > 440Hz

**Accuracy linearly decreases
from ±(2.5% of rdg + 60dgt) @ 200Hz
to ±(7.0% of rdg + 80dgt) @ 440Hz.

Decibel dBm

Range and accuracy are subjected to ACmV, ACV, and reference impedance selected.

Typical 600 reference impedance ranges:

ACmV: -29.83dBm ~ -3.80dBm

ACV: -9.82dBm ~ 54.25dBm

Accuracy: ±0.25dB + 2dgt (40Hz ~ 20kHz)

Input impedance: 10MΩ, 60pF nominal

Selectable reference impedance:

4, 8, 16, 32, 50, 75, 93, 110, 125, 135, 150, 200, 250, 300, 500, 600, 800, 900, 1000, 1200Ω

DC current

Range	Accuracy	Input resistance**
500.00μA	±(0.15% rdg + 20dgt)	Approx. 100Ω
5000.0μA	±(0.1% rdg + 20dgt)	
50.000mA	±(0.15% rdg + 20dgt)	Approx. 1Ω
500.00mA	±(0.15% rdg + 30dgt)	
5.0000A	±(0.8% rdg + 20dgt)	Approx. 0.01Ω
10.000A*	±(0.5% rdg + 20dgt)	

* > 6A: Cool down more than 3 minutes after measuring 1 minute.
< 6A Continuable

**Fusing resistor not included

DC loop current %4~20mA

4mA=0% (zero), 20mA=100%(span)

Resolution: 0.01%, Accuracy: ±25dgt

DC current/AC current and DC+AC current/AC current

Range	Accuracy	Input resistance**
DC, 50Hz ~ 60Hz		
500.00μA	Main display: ±(0.6% rdg + 40dgt) Sub display: ±(0.6% rdg + 4dgt)	Approx. 100Ω
5000.0μA		
50.000mA		Approx. 1Ω
500.00mA		
5.0000A	Main display: ±(1.0% rdg + 40dgt) Sub display: ±(1.0% rdg + 4dgt)	Approx. 0.01Ω
10.000A*		
40Hz ~ 1kHz		
500.00μA	Main display: ±(1.0% rdg + 50dgt) Sub display: ±(1.0% rdg + 5dgt)	Approx. 100Ω
5000.0μA		
50.000mA		Approx. 1Ω
500.00mA		
5.0000A		Approx. 0.01Ω
10.000A*		

* > 6A: Cool down more than 3 minutes after measuring 1 minute.
< 6A Continuable

**Fusing resistor not included

Resistance Ω

Range	Accuracy
500.00Ω	±(0.2% rdg + 10dgt)
5.0000kΩ	±(0.2% rdg + 6dgt)
50.000kΩ	
500.00kΩ	
5.0000MΩ	±(0.8% rdg + 6dgt)
50.000MΩ	±(2.5% rdg + 6dgt)
99.99nS*	±(1.0% rdg + 10dgt)

Open circuit voltage: <1.3Vdc (<3Vdc for 500.00Ω range)

*From 0% to 10% of the range: ±(Specified % of rdg + 30dgt)

Continuity check •••)

Threshold level: 20Ω to 200Ω

Response time: < 100μs

Diode test →

Range	Accuracy	Test current	Open circuit voltage
2.0000V	± (1.0% rdg + 10dgt)	Approx. 0.4mA	< 3.0 V

Temp (°C & °F)**

Range	Accuracy*
-50.0 °C ~ -10.0 °C	±(0.3% rdg + 30dgt)
-10.0 °C ~ 1000.0 °C	±(0.3% rdg + 20dgt)
-58.0 °F ~ 14.0 °F	±(0.3% rdg + 60dgt)
-14.0 °F ~ 1832.0 °F	±(0.3% rdg + 40dgt)

* Accuracy with K-type thermocouple.

K-type thermocouple range and accuracy not included

**Cool down more than 30 minutes after measuring DCA or ACA.

Frequency (Hz)

Range	Input sensitivity*	Frequency range***
500.00mV	100mV	10.00Hz ~ 200.0kHz
5.0000V	0.6V	10.00Hz ~ 100.0kHz
50.000V	6V	
500.00V	50V	
1000.0V	500V	10.00Hz ~ 10.00kHz
LPF 5.0000V	0.5V ~ 2V**	10.00Hz ~ 440.0Hz
LPF 50.000V	5V ~ 20V**	
LPF 500.00V	50V ~ 200V**	
LPF 1000.0V	500V ~ 1000V	10.00Hz ~ 200.0Hz
500.00μA	50μA	15.00Hz ~ 10.00kHz
5000.0μA	500μA	10.00Hz ~ 10.00kHz
50.000mA	5mA	
500.00mA	50mA	
5.0000A	1A	10.00Hz ~ 3.000kHz
10.000A	8A	

Accuracy: Sub display $\pm 0.02\%$ rdg + 4dgt
Main display $\pm 0.02\%$ rdg + 40dgt

* Specified based on sine wave RMS

** LPF sensitivity linearly decreases
from 10% of F.S. @ 200Hz
to 40% of F.S. @ 440Hz.

*** Frequency ranges on the Sub display
A Least Significant Digit will be additionally displayed on the
Main display.

Logic level frequency (\square Hz) and Duty cycle (D%)

DCmV function	Range	Accuracy*
Frequency	5.000Hz ~ 2.0000MHz	$\pm (0.002\% \text{ rdg} + 4\text{dgt})$
Duty cycle	0.1% ~ 99.99%	$\pm (3\text{dgt}/\text{kHz} + 2\text{dgt})$ **

* Sensitivity: 2.5Vp (Square wave) for 3V and 5V logic family

** Specified Frequency: 5Hz to 500kHz

Capacitance $\text{--}\text{||}\text{--}$

Range	Accuracy*
50.00nF 500.0nF	$\pm (0.8\% \text{ rdg} + 3\text{dgt})$
5.000μF	$\pm (1.5\% \text{ rdg} + 3\text{dgt})$
50.00μF	$\pm (2.5\% \text{ rdg} + 3\text{dgt})$
500.0μF**	$\pm (3.5\% \text{ rdg} + 5\text{dgt})$
5.000mF**	$\pm (5.0\% \text{ rdg} + 5\text{dgt})$
25.00mF**	$\pm (6.5\% \text{ rdg} + 5\text{dgt})$

* Accuracies with film capacitor or better

** In manual-ranging mode, measurements not specified below
45.0μF, 0.450mF and 4.5mF for 500.0μF, 5.000mF and 25.00mF
ranges respectively

Max/Min (with capture mode)

Resolution: Equivalent to 5000 counts

Accuracy: \pm (Specified % of rdg + 100dgt) in each function

Sampling time: Approx. 0.8ms

Max/Min (with recording mode)

Accuracy: Specified accuracy in each function

How to calculate an accuracy

Example) DC voltage measurement (DC mV)

Reading: 100.00 [mV]

Range accuracy: $\pm (0.03\% \text{ rdg} + 2\text{dgt})$ in the 500.00mV range

Measuring error: $\pm (100.00 \text{ [mV]} \times 0.03\% \text{ rdg} + 2\text{dgt})$

$\doteq \pm 0.05 \text{ [mV]}$

Calculation: $100.00 \text{ [mV]} \pm 0.05 \text{ [mV]}$

True value: from 99.95 [mV] to 100.05 [mV]

* 2dgt in the 500.00mV range corresponds to 0.02mV.

The product specifications and its appearance described in this manual are subject to change without prior notice for improvements or other reasons.

SANWA®

三和電気計器株式会社

本社=東京都千代田区外神田2-4-4・電波ビル
郵便番号=101-0021・電話=東京(03)3253-4871(代)
大阪営業所=大阪市浪速区恵美須西2-7-2
郵便番号=556-0003・電話=大阪(06)6631-7361(代)
SANWA ELECTRIC INSTRUMENT CO.,LTD.
Dempa Bldg, 4-4 Sotokanda2-Chome Chiyoda-Ku,Tokyo,Japan



TM

This manual employs soy ink.

02-1109 5008 6010