



EPLC9600-CHANNEL8 96 x 96 DIN 1/4 8 Channel PT-100 Scanner

- 128 x 64 Graphical LCD display
- 8 PT-100 temperature sensor inputs
- ON-OFF control
- Relay or (pnp “source”) transistor output
- Sensor error detection
- Adjustable temperature offset
- 3 Different alarm and pre-alarm types for each channel (High, Low and Band Alarms)
- User defined channel labels
- Display scan modes
- Operating with Real Time Clock (RTC)
- ModBus RTU communication protocol (RS-232, RS-485 and Ethernet communication)
- Data Logging to USB Flash Memory
- Adjustable data logging time interval
- Password protection for programming mode

ABOUT INSTRUCTION MANUAL

Instruction manual of EPLC9600-CHANNEL8 consists of two main sections. Explanation of these sections are below. Also, there are other sections which include order information and technical specifications of the device. All titles and page numbers in instruction manual are in “**CONTENTS**” section. User can reach to any title with section number.

Installation:

In this section, physical dimensions of the device, panel mounting, electrical wiring, physical and electrical installation of the device to the system are explained.

Operation and Parameters:

In this section user interface of the device, accessing to the parameters, description of the parameters are explained.

Also in these sections, there are warnings to prevent serious injury while doing the physical and electrical mounting or using the device.

Explanation of the symbols which are used in these sections are given below.



This symbol is used for safety warnings. User must pay attention to these warnings.



This symbol is used to determine the dangerous situations as a result of an electric shock. User must pay attention to these warnings definitely.



This symbol is used to determine the important notes about functions and usage of the device.

CONTENTS

1.PREFACE	Page	5
1.1 GENERAL SPECIFICATIONS		
1.2 ORDERING INFORMATION		
1.3 WARRANTY		
1.4 MAINTENANCE		
2.INSTALLATION	Page	7
2.1 GENERAL DESCRIPTION		
2.2 FRONT VIEW AND DIMENSIONS OF EPLC9600-CHANNEL8		
2.3 PANEL CUT-OUT		
2.4 ENVIRONMENTAL RATINGS		
2.5 PANEL MOUNTING		
2.6 INSTALLATION FIXING CLAMP		
2.7 REMOVING FROM THE PANEL		
3.ELECTRICAL WIRING	Page	12
3.1 TERMINAL LAYOUT AND CONNECTION INSTRUCTIONS		
3.2 ELECTRICAL WIRING DIAGRAM		
3.2.1 DEVICE WITH RELAY OUTPUTS		
3.2.2 DEVICE WITH TRANSISTOR OUTPUTS		
3.3 SUPPLY VOLTAGE INPUT CONNECTION OF THE DEVICE		
3.4 SUPPLY VOLTAGE INPUT CONNECTION OF TRANSISTOR OUTPUTS		
3.5. GALVANIC ISOLATION TEST VALUE OF EPLC9600-CHANNEL8 WITH RELAY OUTPUTS		
3.6. GALVANIC ISOLATION TEST VALUE OF EPLC9600-CHANNEL8 WITH TRANSISTOR OUTPUTS		
4. CABLE CONNECTION BETWEEN RS232 TERMINAL OF THE DEVICE AND PC	Page	19
5. CONNECTION FOR RS485 SERIAL COMMUNICATION	Page	20
6. DEFINITION OF THE FRONT PANEL AND ACCESSING TO THE PARAMETERS	Page	21
6.1 DEFINITION OF FRONT PANEL		
6.2 MAIN OPERATION SCREEN DEFINITION		
6.3 ACCESSING TO THE OPERATOR PARAMETER PAGES		
6.4 ACCESSING TO THE TECHNICIAN PARAMETER PAGES		
6.5 OPERATOR PAGES PARAMETERS DEFINITIONS		
6.6 TECHNICIAN PAGES PARAMETERS DEFINITIONS		
6.6.1 PAGE-1 PARAMETERS		
6.6.2 PAGE-2 PARAMETERS		
6.6.3 PAGE-3 AND PAGE-4 PARAMETERS		
6.6.4 RS232 SETUP PAGES PARAMETERS		
6.6.5 RS485 SETUP PAGES PARAMETERS		
6.6.6 USB SETUP PAGES PARAMETERS		
6.6.7 ETHERNET SETUP PAGES PARAMETERS		
6.6.8 REAL TIME (RTC) SETUP PAGES PARAMETERS		
7.OPERATION GRAPHICS OF ALARM AND PRE-ALARM TYPE	Page	39
8.MODBUS ADDRESS	Page	40
8.1 OUTPUT ADDRESSES		
8.2 PROCESS VALUES ADDRESSES		
9.SPECIFICATIONS	Page	41
10.OTHER INFORMATIONS	Page	41

EU DECLARATION OF CONFORMITY

Manufacturer's Name : EMKO ELEKTRONIK A.S.
Manufacturer's Address : DOSAB, Karanfil Sk., No:6,
16369 Bursa, TURKEY

The manufacturer hereby declares that the product:

Product Name : CHANNEL8 (8 Channel PT-100 Scanner)
Type Number : EPLC9600
Product Category : Electrical equipment for measurement, control and laboratory use

Conforms to the following directives :

2006 / 95 / EC The Low Voltage Directive

2004 / 108 / EC The Electromagnetic Compatibility Directive

has been designed and manufactured to the following specifications:

EN 61000-6-4:2007 EMC Generic Emission Standard for Industrial Environments

EN 61000-6-2:2005 EMC Generic Immunity Standard for Industrial Environments

EN 61010-1:2001 Safety Requirements for electrical equipment for measurement, control and laboratory use

When and Where Issued

22nd June 2011

Bursa-TURKEY

Authorized Signature

Name : Serpil YAKIN

Position : Quality Manager

1.Preface

EPLC9600-CHANNEL8 series 8 channel PT100 scanner devices are designed for measuring and logging temperature. They can be used in many applications with their PT-100 process input, alarm outputs, selectable alarm functions, RS-232 / RS-485 / Ethernet / USB communications.

Application Fields

Glass
Plastic
Petro-Chemistry
Textile
Automotive
Machine production industries
etc...

Applications

Heating
Baking Ovens
Incubators
Storages
Air Conditioning
etc..

1.1 General Specifications

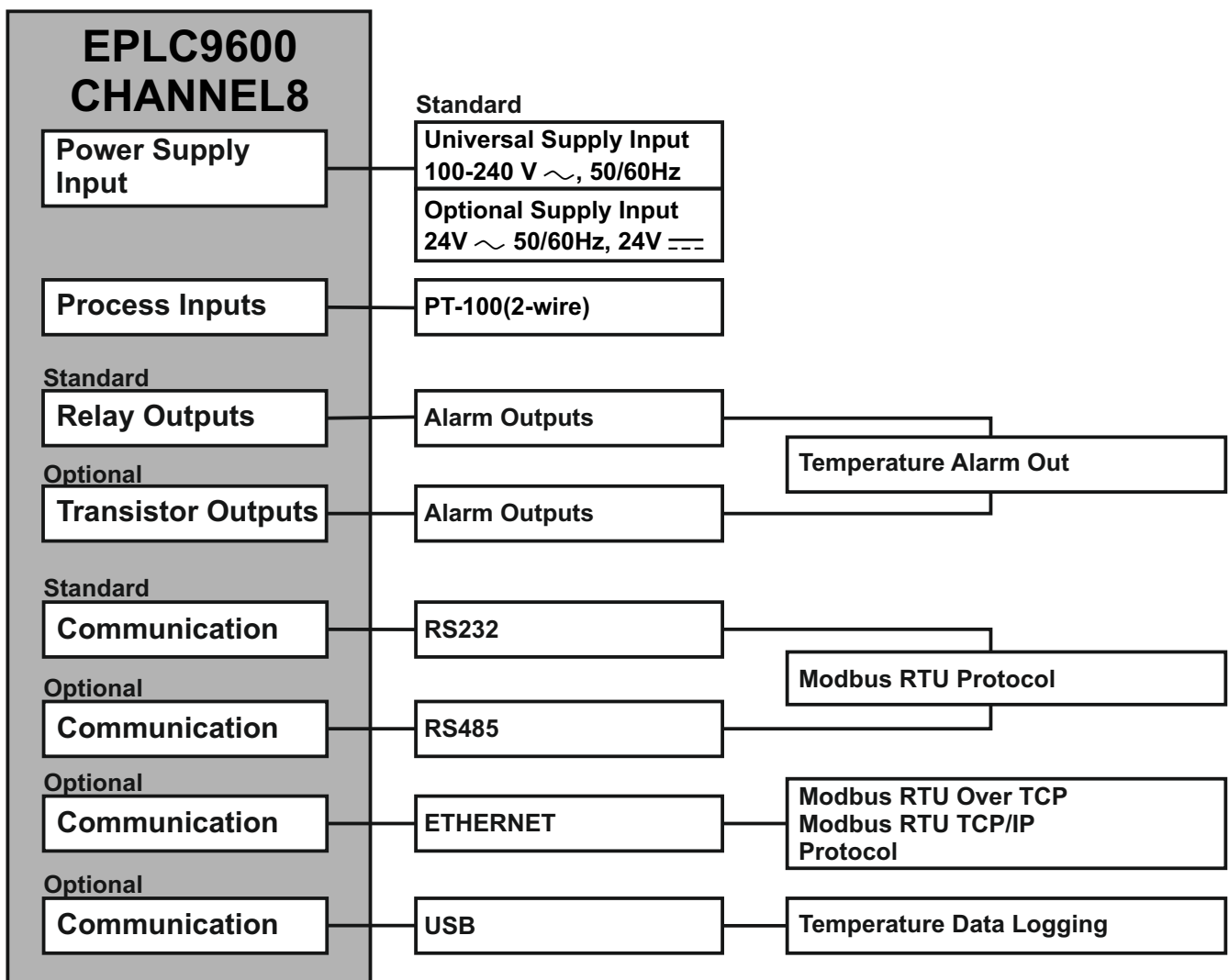

1.2 Ordering Information

EPLC9600-CHANNEL8 (96 x 96 1/4 DIN)	A	.	B	C	D	E
		.		2		

A Supply Voltage	
1	100...240V ~ (- %15;+%10) 50/60Hz
2	24V~(-%15;+%10) 50/60Hz 24V===(-%15;+%10)
9	Customer

B Outputs	
R	10 Relay outputs with 2 common for each NO contact 5A max. (5A@250V at resistive load) for each Common contact 15A max (15A@250V at resistive load)
T	10 pnp "source" Transistor outputs Output current 1A Max. for each transistor output.

C Standard Serial Communication	
2	RS-232 (up to 115200 baudrate, "No isolation")

D Optional Communication-1	
0	None
4	RS-485 (up to 115200 baudrate, "500VAC isolation")
E	ETHERNET (10Mbit/s, "1500VAC isolation")

E Optional Communication-2	
0	None
U	USB (USB2.0 "for temperature data logging")

All order information of EPLC9600-CHANNEL8 are given on the table at left. User may form appropriate device configuration from information and codes that at the table and convert it to the ordering codes.

Firstly, supply voltage then other specifications must be determined. Please fill the order code blanks according to your needs.

Please contact us, if your needs are out of the standards.

1.3 Warranty

EMKO Elektronik warrants that the equipment delivered is free from defects in material and workmanship. This warranty is provided for a period of two years. The warranty period starts from the delivery date. This warranty is in force if duty and responsibilities which are determined in warranty document and instruction manual performs by the customer completely.

1.4 Maintenance

Repairs should only be performed by trained and specialized personnel. Cut power to the device before accessing internal parts.

Do not clean the case with hydrocarbon-based solvents (Petrol, Trichlorethylene etc.). Use of these solvents can reduce the mechanical reliability of the device. Use a cloth dampened in ethyl alcohol or water to clean the external plastic case.

2. Installation



Before beginning installation of this product, please read the instruction manual and warnings below carefully.

In package ,

- One piece unit
- Two pieces mounting clamps
- One piece instruction manual

A visual inspection of this product for possible damage occurred during shipment is recommended before installation. It is your responsibility to ensure that qualified mechanical and electrical technicians install this product.

If there is danger of serious accident resulting from a failure or defect in this unit, power off the system and separate the electrical connection of the device from the system.

The unit is normally supplied without a power supply switch or a fuse. Use power switch and fuse as required.

Be sure to use the rated power supply voltage to protect the unit against damage and to prevent failure.

Keep the power off until all of the wiring is completed so that electric shock and trouble with the unit can be prevented.

Never attempt to disassemble, modify or repair this unit. Tampering with the unit may results in malfunction, electric shock or fire.

Do not use the unit in combustible or explosive gaseous atmospheres.

During the equipment is putted in hole on the metal panel while mechanical installation some metal burrs can cause injury on hands, you must be careful.

Montage of the product on a system must be done with it's fixing clamps. Do not do the montage of the device with inappropriate fixing clamp. Be sure that device will not fall while doing the montage.

It is your responsibility if this equipment is used in a manner not specified in this instruction manual.

2.1 General Description

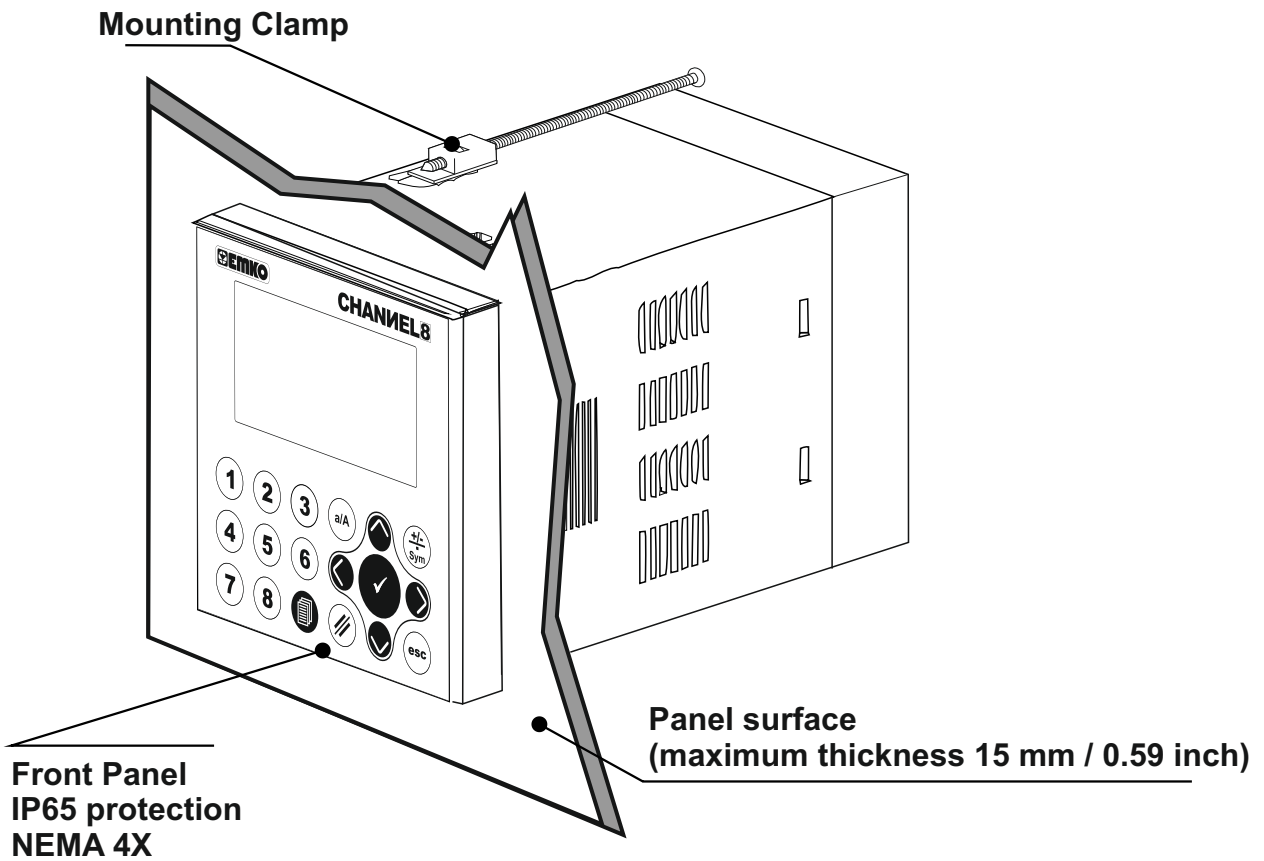

2.2 Front View and Dimensions of EPLC9600-CHANNEL8

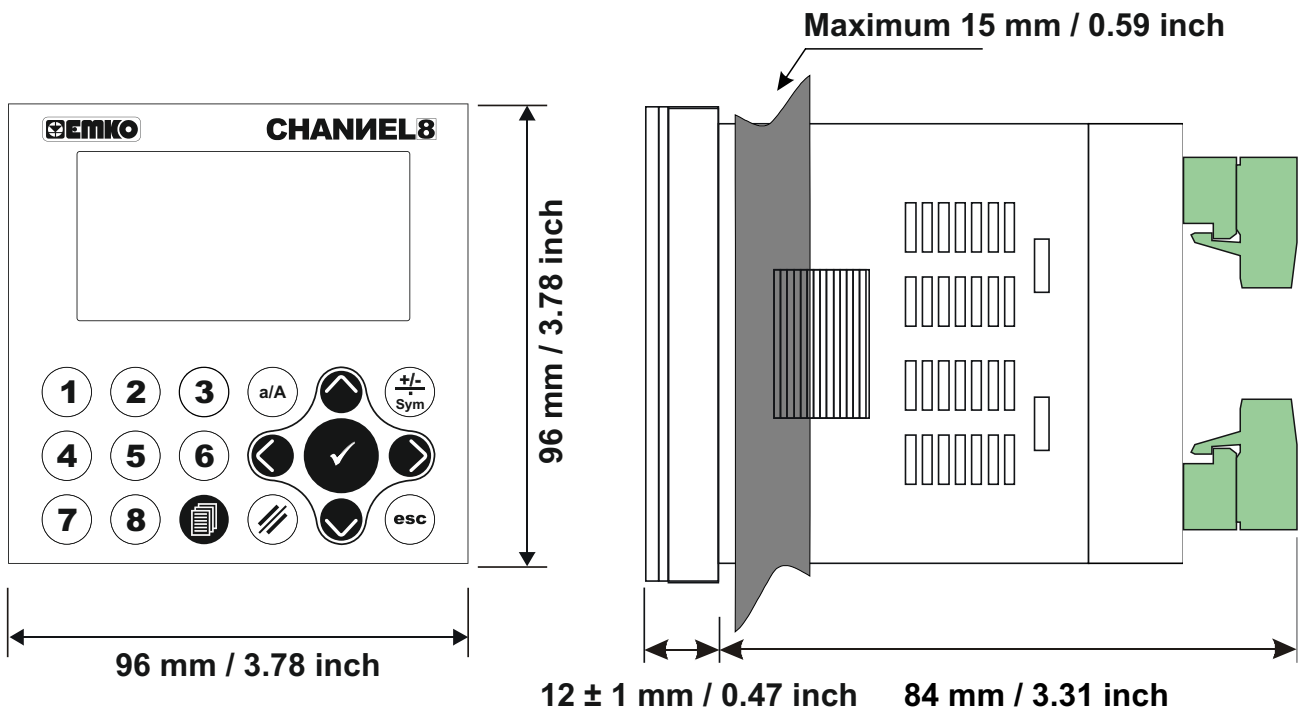

2.3 Panel Cut-out

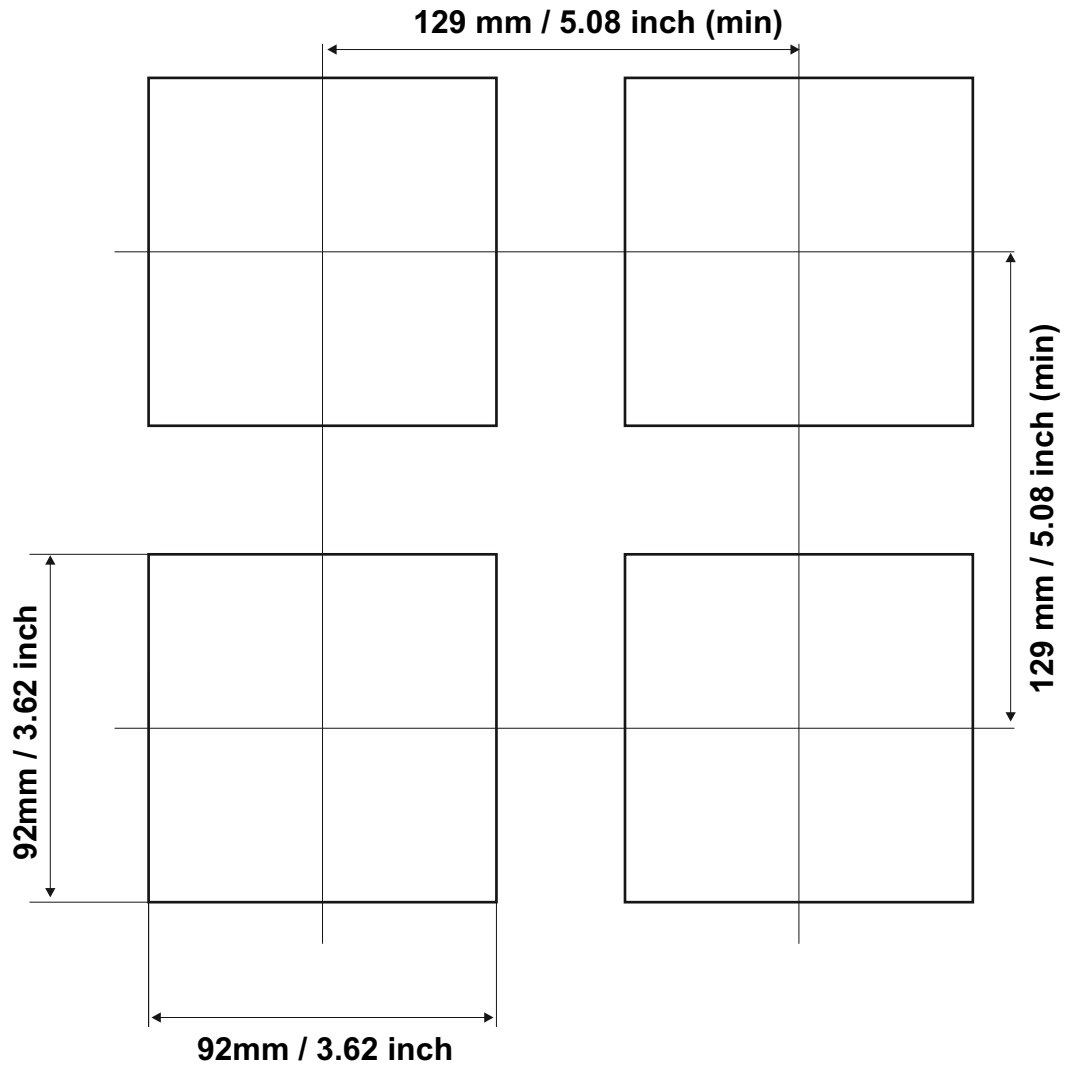

2.4 Environmental Ratings

Operating Conditions



Operating Temperature : 0 to 50 °C



Max. Operating Humidity : 90% Rh (non-condensing)



Altitude : Up to 2000m.



Forbidden Conditions:

Corrosive atmosphere

Explosive atmosphere

Home applications (The unit is only for industrial applications)

2.5 Panel Mounting

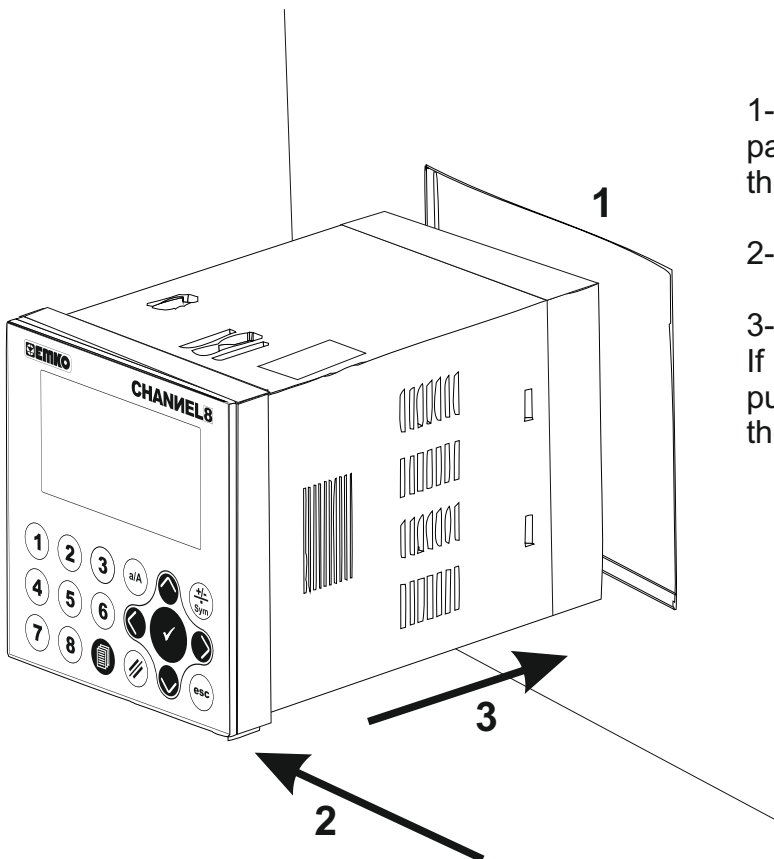

1-Before mounting the device in your panel, make sure that the cut-out is of the right size.

2-Check front panel gasket position

3-Insert the device through the cut-out. If the mounting clamps are on the unit, put out them before inserting the unit to the panel.



During installation into a metal panel, care should be taken to avoid injury from metal burrs which might be present. The equipment can loosen from vibration and become dislodged if installation parts are not properly tightened. These precautions for the safety of the person who does the panel mounting.

2.6 Installation Fixing Clamp

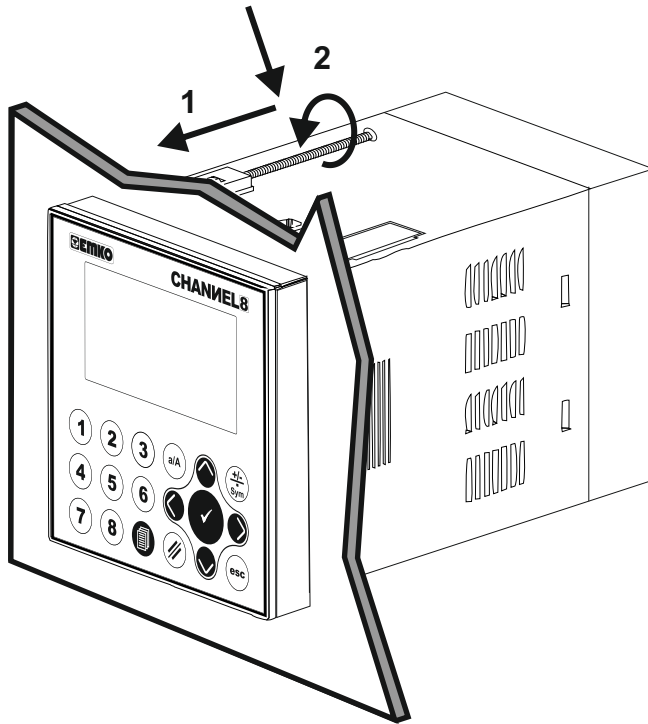

The unit is designed for panel mounting.

1-Insert the unit in the panel cut-out from the front side.

2- Insert the mounting clamps to the holes that located top and bottom sides of device and screw up the fixing screws until the unit completely immobile within the panel



Montage of the unit to a system must be done with it's own fixing clamps. Do not do the montage of the device with inappropriate fixing clamps. Be sure that device will not fall while doing the montage.

2.7 Removing from the Panel



Before starting to remove the unit from panel, power off the unit and the related system.

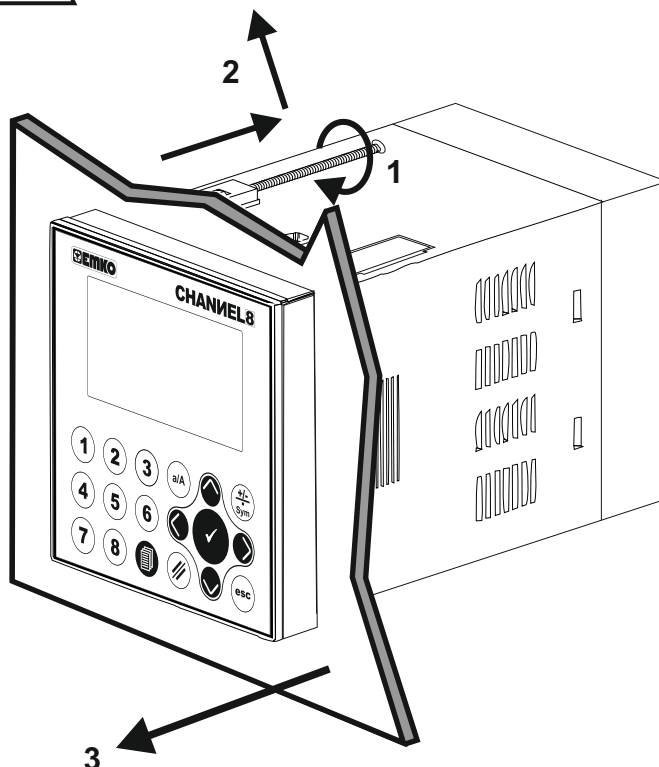

1-Loosen the screws.

2-Pull mounting clamps from top and bottom fixing sockets.

3-Pull the unit through the front side of the panel

3. Electrical Wirings



You must ensure that the device is correctly configured for your application. Incorrect configuration could result in damage to the process being controlled, and/or personal injury. It is your responsibility, as the installer, to ensure that the configuration is correct.

Device parameters has factory default values. These parameters must be set according to the system's needs.



Only qualified personnel and technicians should work on this equipment. This equipment contains internal circuits with voltage dangerous to human life. There is severe danger for human life in the case of unauthorized intervention.



Be sure to use the rated power supply voltage to protect the unit against damage and to prevent failure.



Keep the power off until all of the wiring is completed so that electric shock and trouble with the unit can be prevented.

3.1 Terminal Layout and Connection Instructions

Terminal layout for ethernet communication

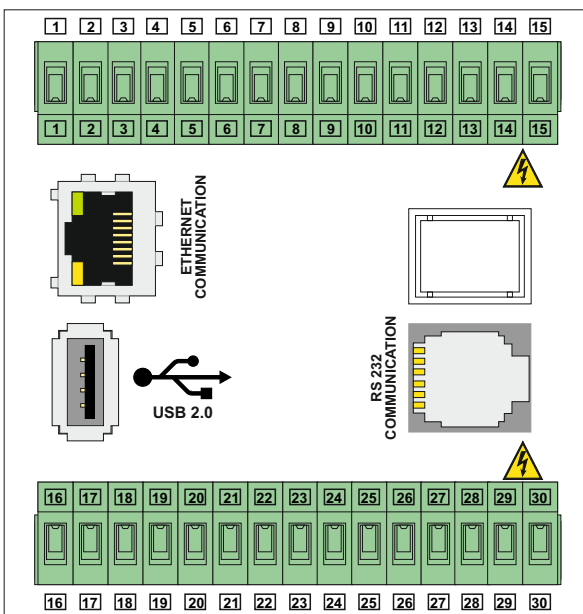

Terminal layout for RS485 communication

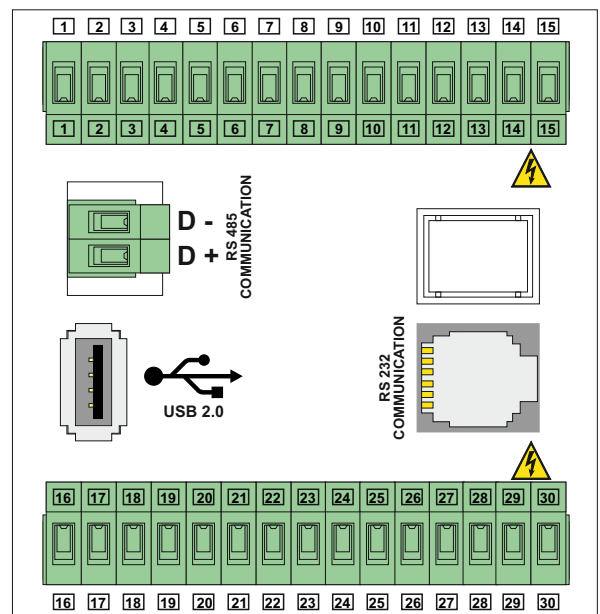

Max. 2.5mm / 0.098 inch
Wire Size:
18AWG/1mm²
Solid /Stranded

Torque
0,5Nm

Screw driver
0,8 x3mm

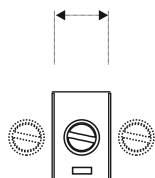

3.2 Electrical Wiring Diagram

3.2.1 Device with Relay Outputs



Electrical wiring of the device must be the same as 'Electrical Wiring Diagram' below to prevent damage to the process being controlled and personnel injury.

Power Supply Input
 100...240V ~ (-%15;+%10) 50/60Hz 7VA
 24V~(-%15;+%10) 50/60Hz 7VA
 24V---(-%15;+%10) 7W
 (It must be determined in order.)

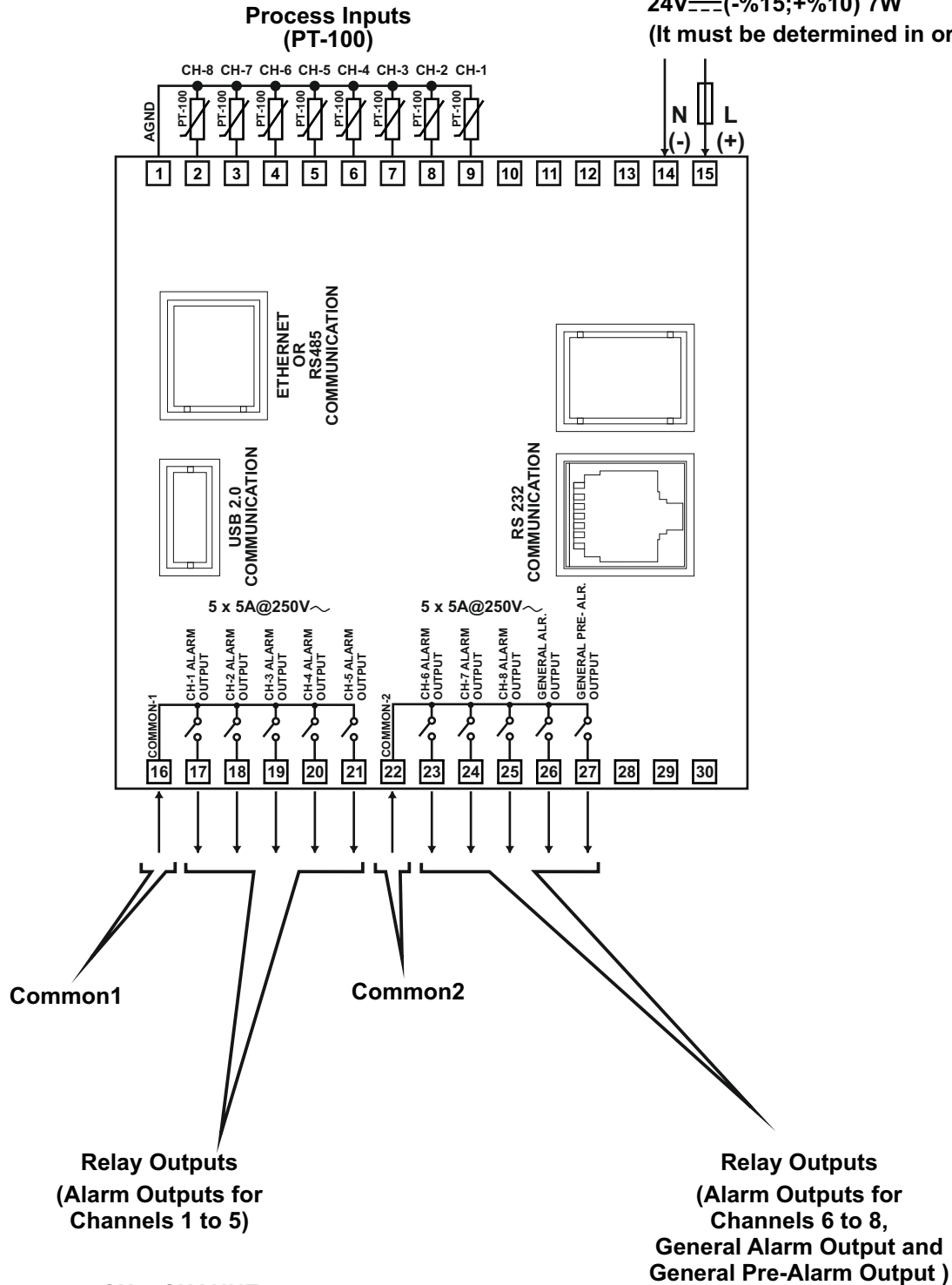

CH = CHANNEL

RS485, Ethernet and USB communications are optional

3.2.2 Device with Transistor Outputs



Electrical wiring of the device must be the same as 'Electrical Wiring Diagram' below to prevent damage to the process being controlled and personnel injury.

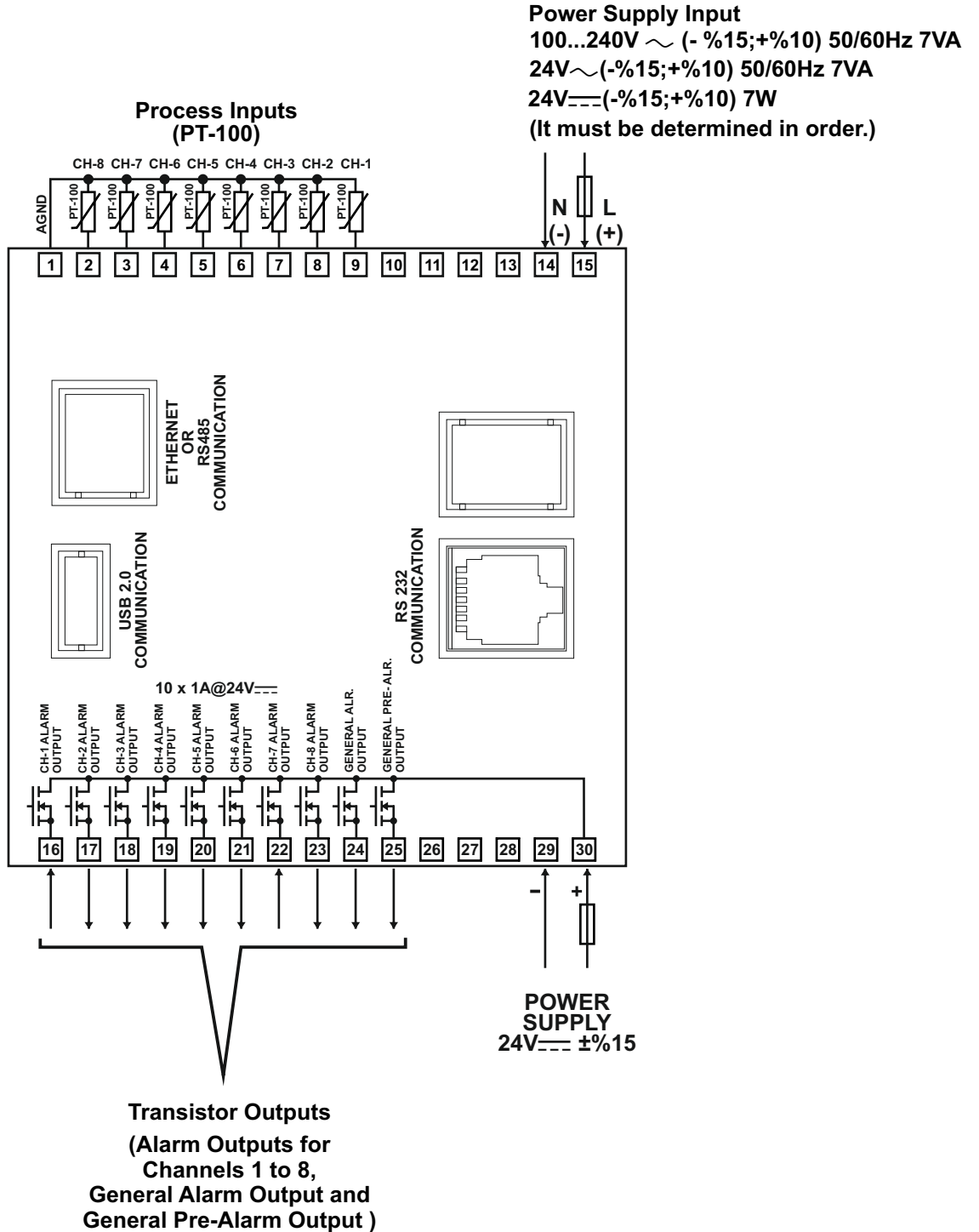

CH = CHANNEL

RS485, Ethernet and USB communications are optional

3.3 Supply Voltage Input Connection of the Device

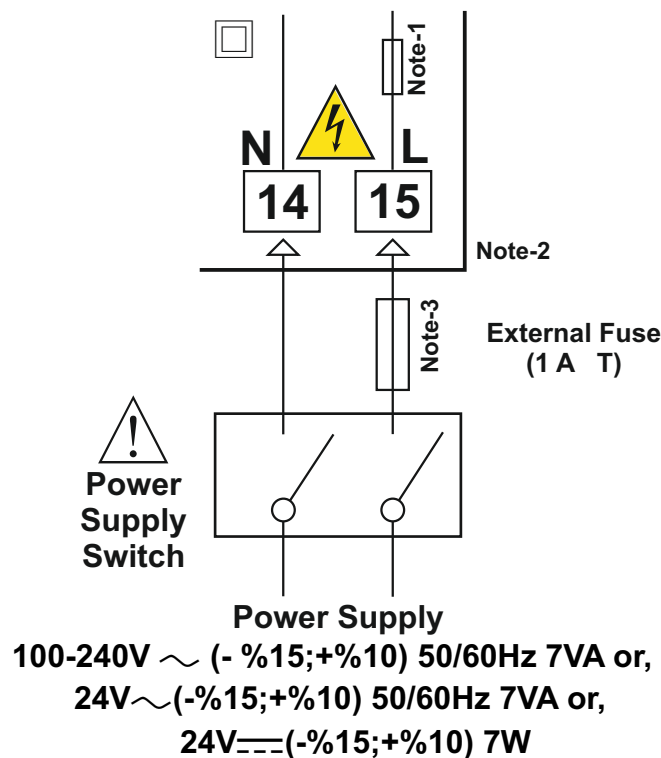

Note-1 : There is an internal 33R Ω fusible flameproof resistor in 100-240 V \sim 50/60Hz
 There is an internal 4R7 Ω fusible flameproof resistor in 24V \sim 50/60Hz

Note-2: “L” is (+), “N” is (-) for 24V $===$ Supply Voltage

Note-3: External Fuse is recommended



Make sure that the power supply voltage is same indicated on the instrument. Switch on the power supply only after that all the electrical connection have been completed.

Supply voltage range must be determined in order. While installing the unit, supply voltage range must be controlled and appropriate supply voltage must be applied to the unit. Controlling prevents damages in unit and system and possible accidents as a result of incorrect supply voltage.



There is no power supply switch or fuse on the device. So a power supply switch and a fuse must be added to the supply voltage input. Power supply switch and fuse must be put to a place where user can reach easily.

Power supply switch must be two poled for seperating phase and neutral. On/Off condition of power supply switch is very important in electrical connection. On/Off condition of power supply switch must be signed for preventing the wrong connection.

External fuse must be on phase connection in \sim supply input.

External fuse must be on (+) line connection in $===$ supply input.



The instrument is protected with an internal fuse (Please refer to Note-1 for information). In case of failure it is suggested to return the instrument to the manufacturer for repair.

3.4 Supply Voltage Input Connection of the Transistor Outputs



This power supply connection is need only when transistor type outputs are used.

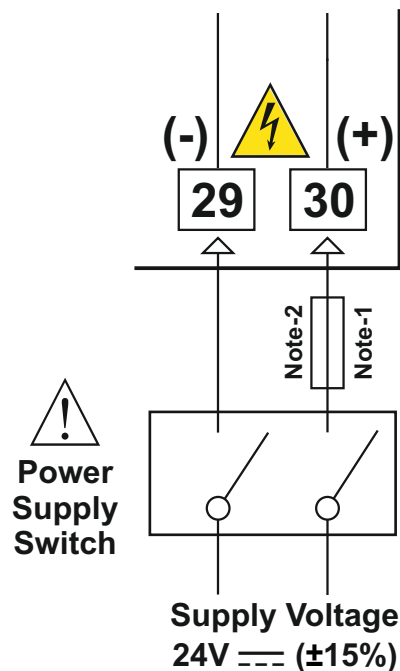

Note-1 : External fuse is recommended.

Note-2 : Fuse value must be select according to the system.



Make sure that the power supply voltage is the same indicated on the instrument.

Switch on the power supply only after that all the electrical connections have been completed.

While installing the unit, supply voltage range must be controlled and appropriate supply voltage must be applied to the unit. Controlling prevents damages in unit and system and possible accidents as a result of incorrect supply voltage.



There is no power supply switch on the device. So a power supply switch must be added to the supply voltage input. In accordance with the safety regulations, the power supply switch shall bring the identification of the relevant instrument. Power supply switch shall be easily accessible by the user.

Power switch must be two poled for seperating phase and neutral. On/Off condition of power switch is very important in electrical connection. On/Off condition of power switch must be signed for preventing the wrong connection.

If an external fuse is used, it must be on (+) line connection in ---supply input.

3.5 Galvanic Isolation Test Values of EPLC9600-CHANNEL8 with Relay Outputs

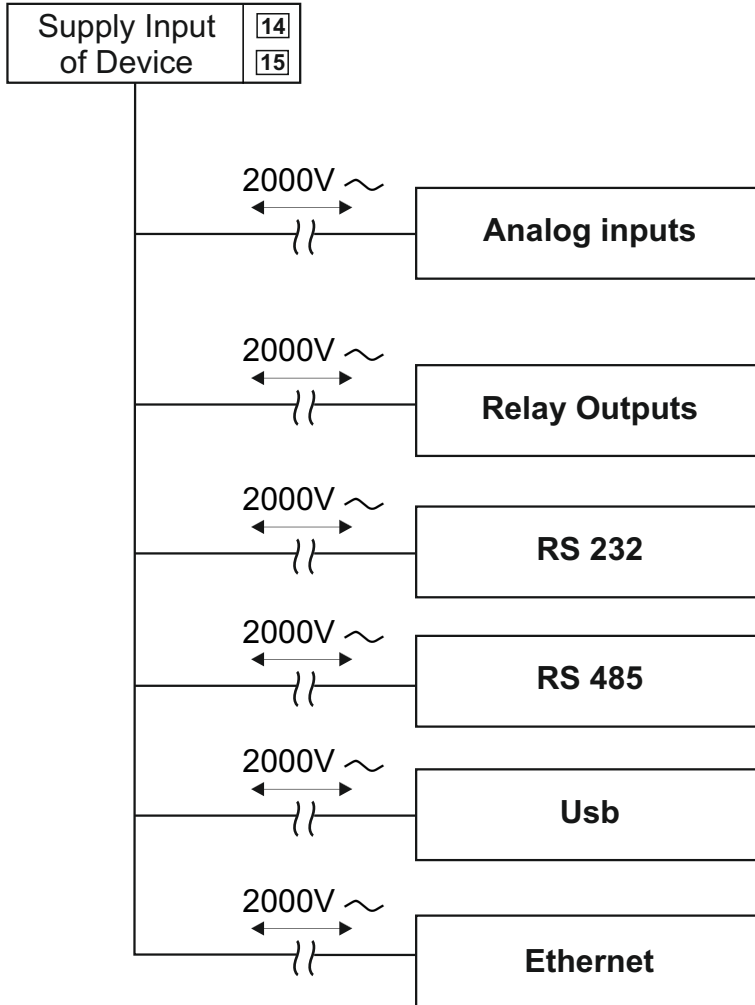

3.6 Galvanic Isolation Test Values of EPLC9600-CHANNEL8 with Transistor Outputs

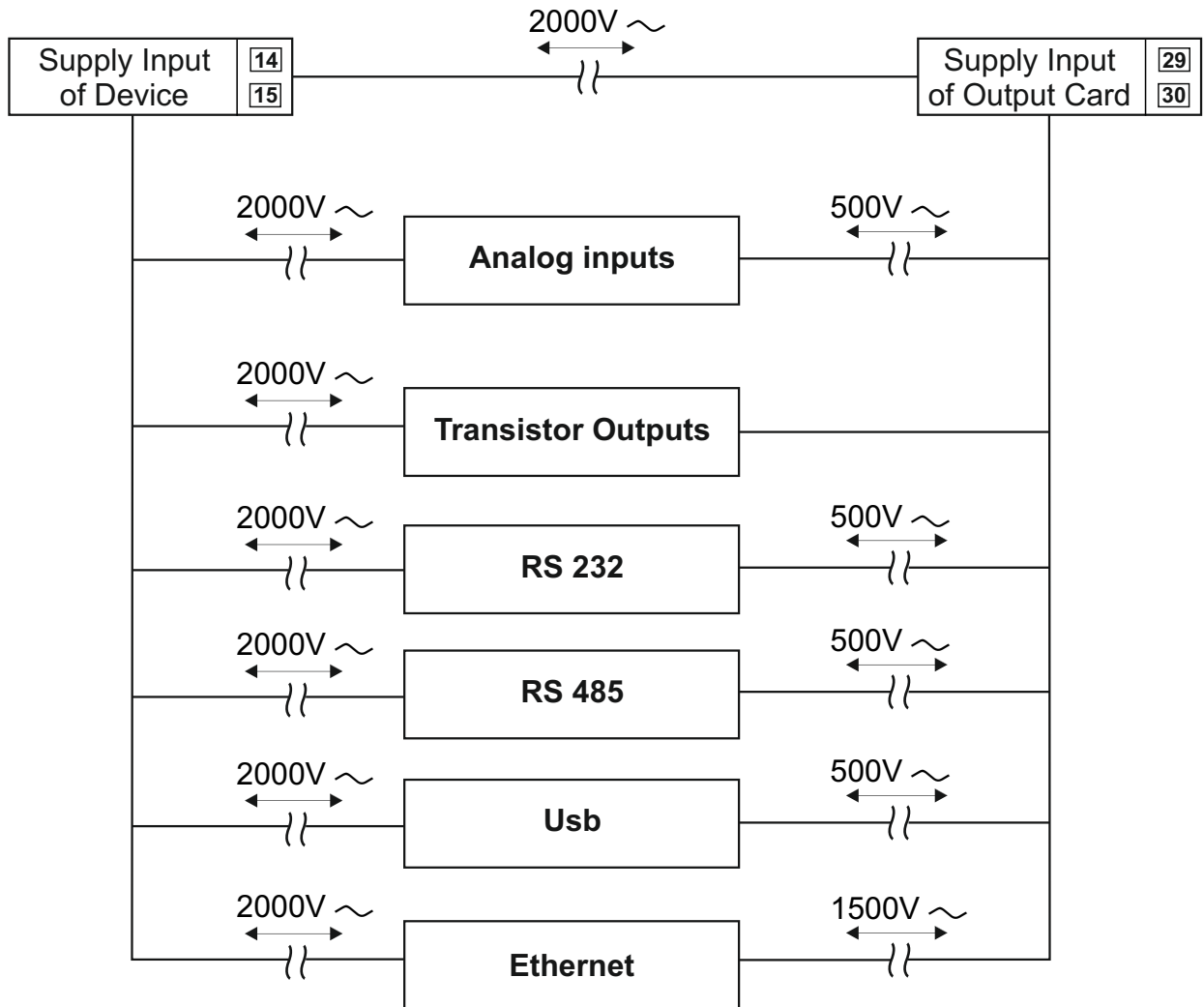

4. Cable Connection Between RS-232 Terminal of the Device and PC

PC (Personal Computer)
9 Pin DCON connection

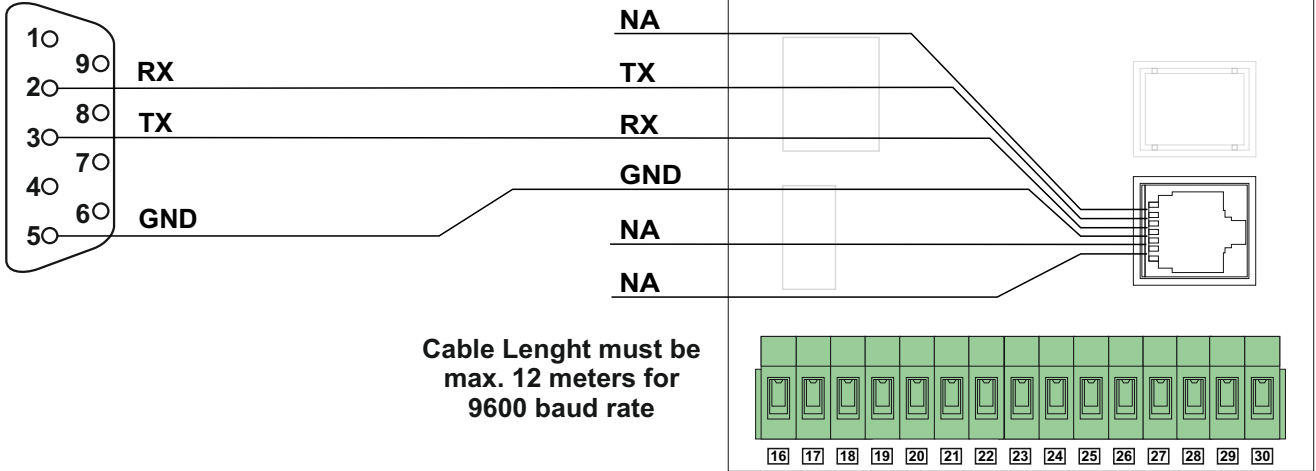

5. Connection for RS-485 Serial Communication

PC(Personal Computer)

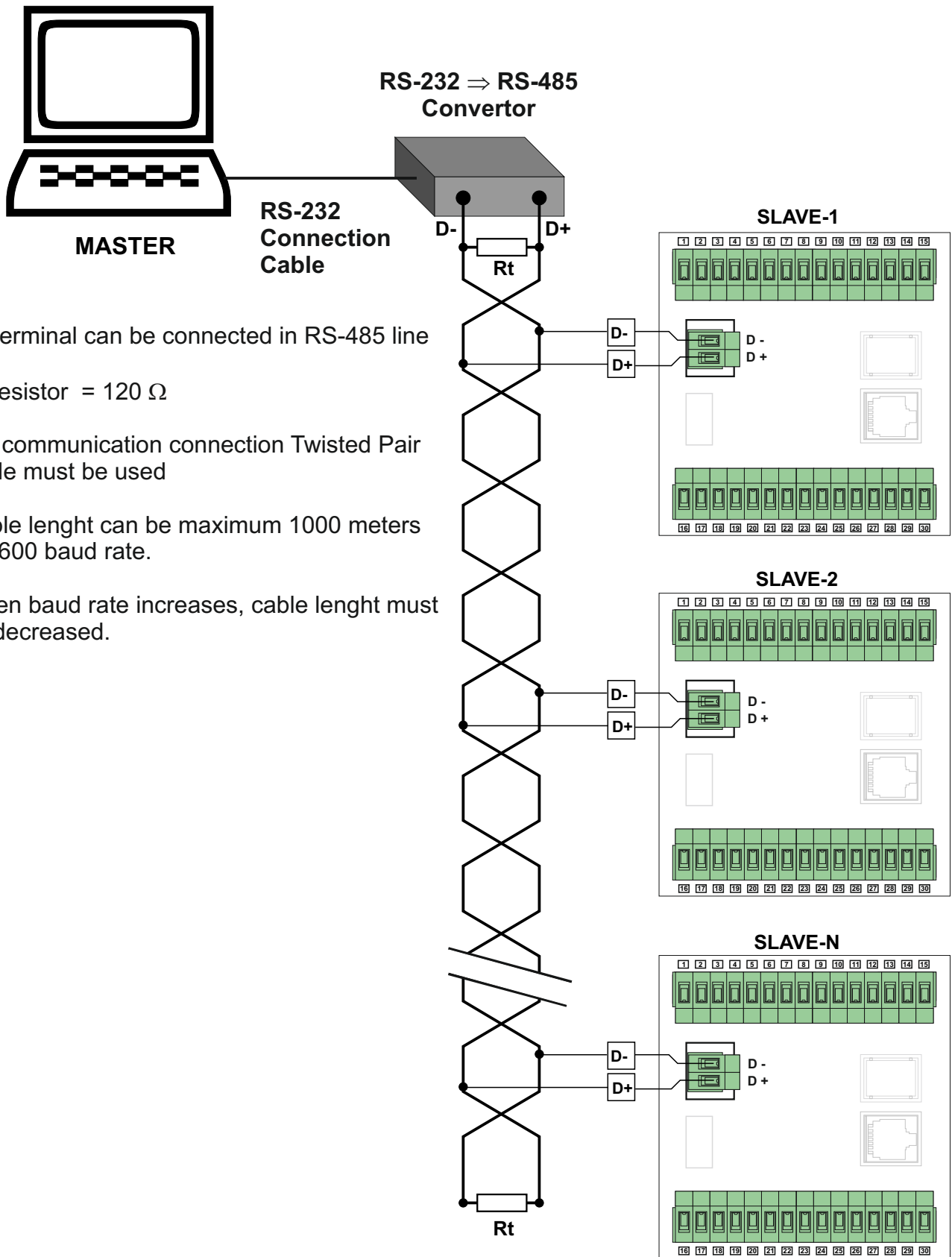

32 terminal can be connected in RS-485 line

R_t resistor = 120 Ω

For communication connection Twisted Pair cable must be used

Cable length can be maximum 1000 meters in 9600 baud rate.

When baud rate increases, cable length must be decreased.

6. Definition of the Front Panel and Accessing to the Parameters

6.1. Definition of Front Panel

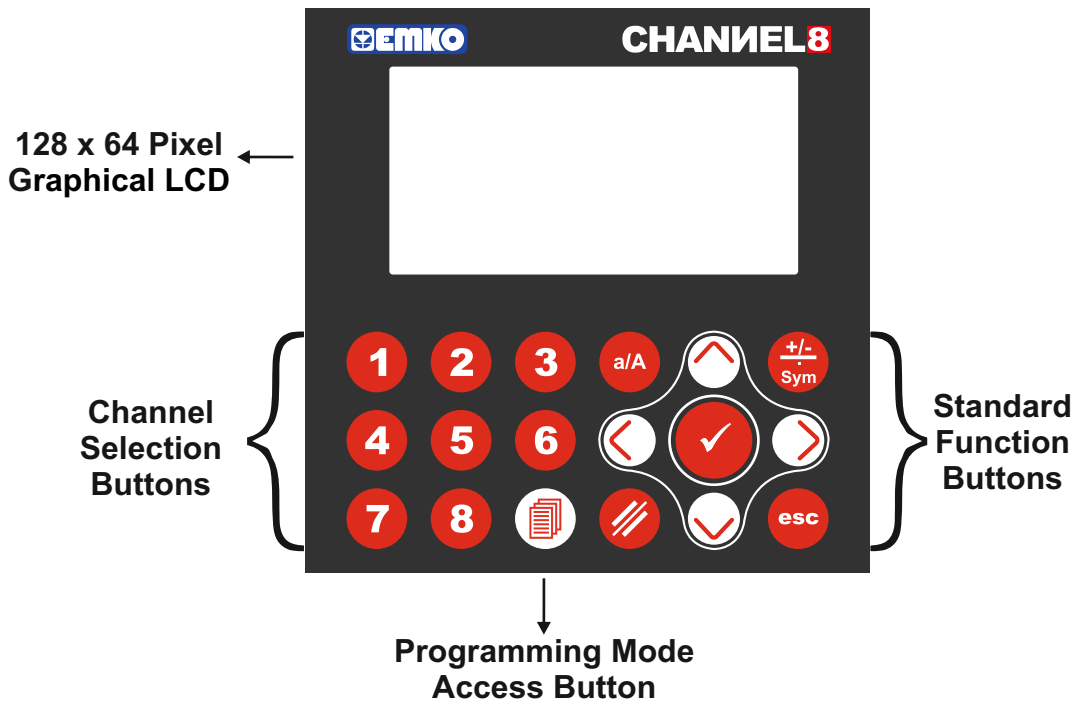

ENTER BUTTON

This button is used to confirm the variable value in variable value changing screen.



ESCAPE BUTTON

This button is used to exit from variable value changing screen to preceding visualization screen without saving variable value, and return to main operation screen.



DELETE BUTTON

This button is used to delete the last digit of the value in variable value changing screen.



CHANGE CASE BUTTON

This button is used to changing the character between uppercase and lowercase, which cursor is show for string variable in variable value changing screen.



SIGN & SYMBOL BUTTON

This button is used to changing the sign value for sign type variables, entering the dot for real type and entering the symbol character for string type variables in variable value changing screen.



DOWN BUTTON

This button is used to decrement the digit, which cursor is show of variable in variable value changing screen and used to accessing next programming page in programming mode.



UP BUTTON

This button is used to increment the digit, which cursor is show of variable in variable value changing screen and used to accessing previous programming page in programming mode.



RIGHT BUTTON

This button is used to move cursor to the right side for one digit in variable value changing screen and selecting the variable for changing in programming mode.



LEFT BUTTON

This button is used to move cursor to the left side for one digit in variable value changing screen and selecting the variable for changing in programming mode.



PROGRAMMING MODE ACCESSING BUTTON

This button is used to accessing to programming mode parameters pages.

6.2. Main Operation Screens Definition

If the display type parameter value **DSP.TYPE = 1**

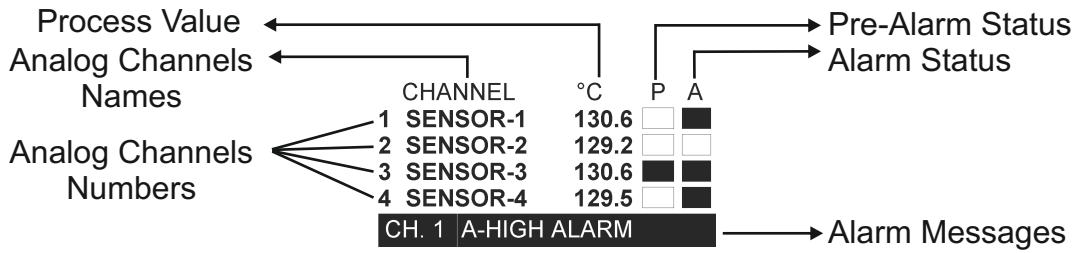

MAIN OPERATION SCREEN-1

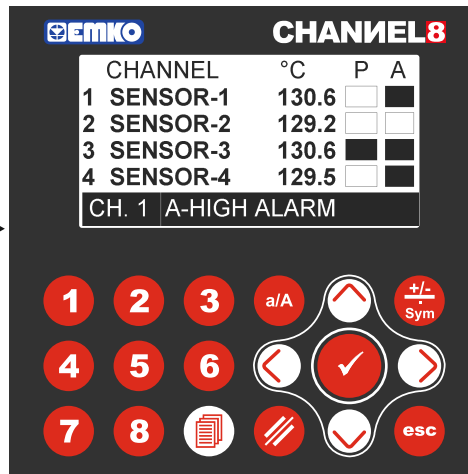

Press right button for accessing the main operation screen-2

MAIN OPERATION SCREEN-2

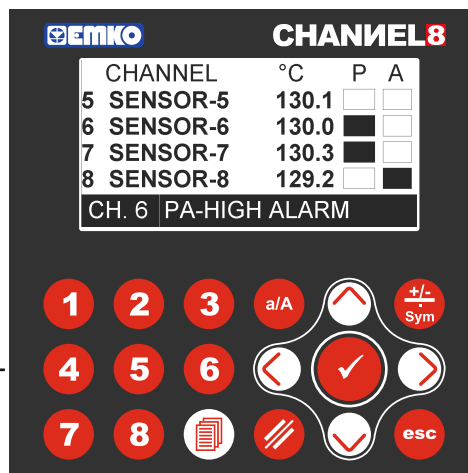

Press left button for accessing the main operation screen-1



If more than one alarm messages is present, each alarm message is showing on LCD screen during 1 second.



If the display scan parameter value **DSP.SCAN = 1**, each main operation screen is showing on LCD screen during time defined by **SCAN TIME** parameter value.

If the display type parameter value **DSP.TYPE = 2**

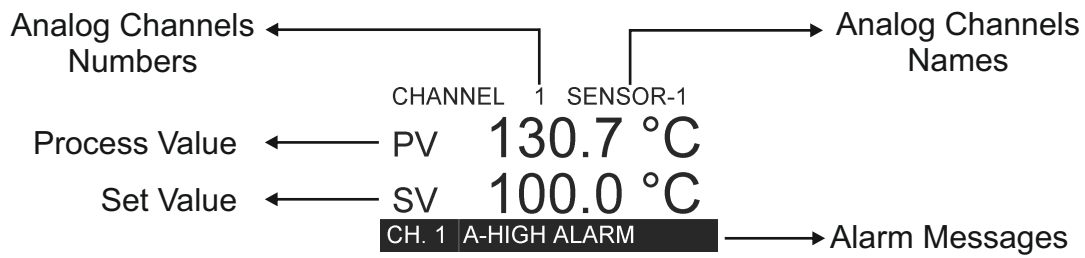

MAIN OPERATION (CHANNEL-1 SCREEN)

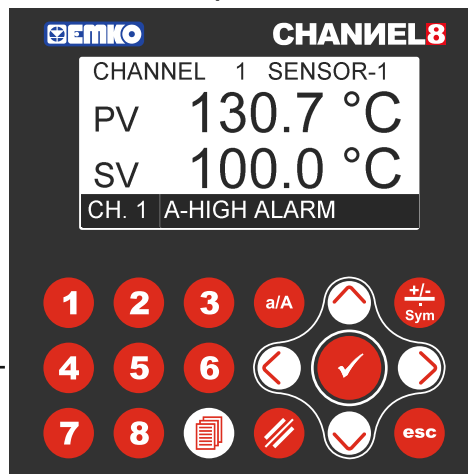

Press number (1,2,3,4,5,6,7 or 8) buttons for accessing the relevant channel screen.

MAIN OPERATION (CHANNEL-4 SCREEN)

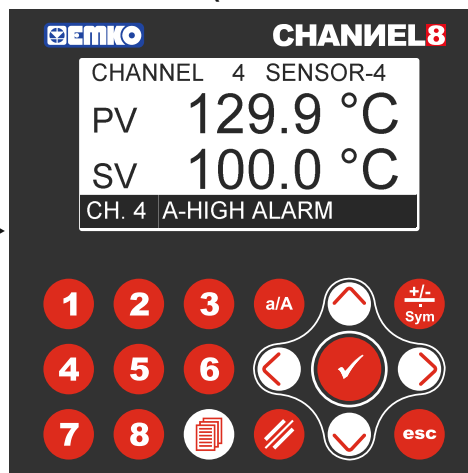

i If more than one alarm messages is present, each alarm message is showing on LCD screen during 1 second.

i If the display scan parameter value DSP.SCAN = 1, each main operation screen is showing on LCD screen during time defined by SCAN TIME parameter value.

6.3. Accessing to the Operator Parameter Pages

MAIN OPERATION SCREEN

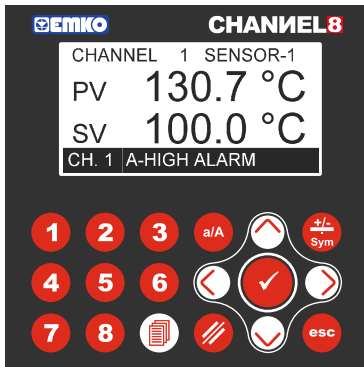

OPERATOR PARAMETERS SECTION PASSWORD SCREEN



When programming mode access button is pressed and released before 5 seconds is expire, If operator password is different from 0, operator parameter section password screen will be observed, If operator password is 0 then operator parameter screen will be observed.

Press right or left button for selecting the password parameter.

OPERATOR PARAMETERS SECTION PASSWORD SCREEN



Press enter button for accessing to password entering screen.

OPERATOR PARAMETERS SECTION PASSWORD ENTERING SCREEN



Enter the operator parameter section password with cursor (lef, right, up and down) buttons.

OPERATOR PARAMETERS SECTION PASSWORD ENTERING SCREEN



Press enter button for accessing to the operator section parameters.

OPERATOR PARAMETER SCREEN (CHANNEL-1 PARAMETERS)

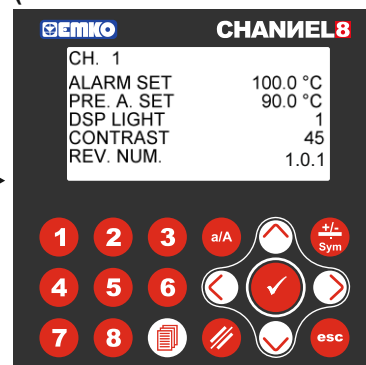

Press right or left button for selecting the parameter.



If no operation is performed for 20 seconds in operator parameters section, device turns to main operation screen automatically.

OPERATOR PARAMETER SCREEN (CHANNEL-1 PARAMETERS)

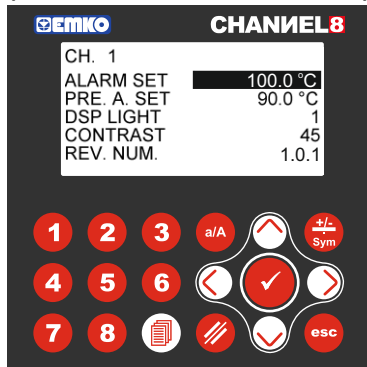

Press enter button for accessing to parameter entering screen.

PARAMETER ENTERING SCREEN



Change the parameter value with cursor (lef, right, up and down) buttons.

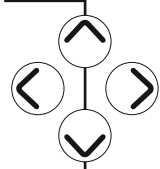

PARAMETER ENTERING SCREEN

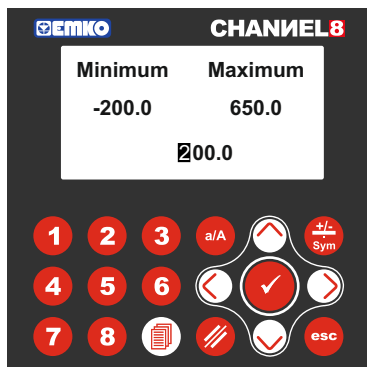

Press enter button for return parameter screen with saving parameter value, press escape button for return parameter screen without saving parameter value.

OPERATOR PARAMETER SCREEN (CHANNEL-1 PARAMETERS)

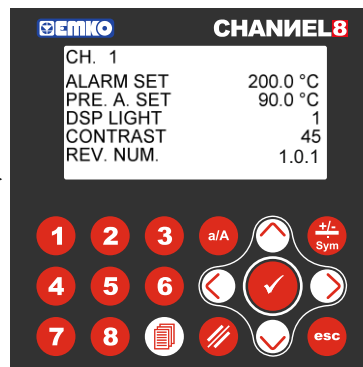

Press number (1,2,3,4,5,6,7 or 8) buttons for accessing the relevant channel's parameter screen.

OPERATOR PARAMETER SCREEN (CHANNEL-7 PARAMETERS)

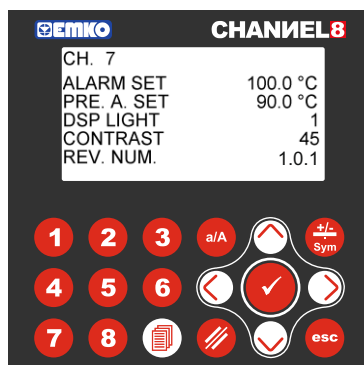

Other operator section parameters can be accessed with same method explained above, press escape button for return to main operation screen.



If no operation is performed for 20 seconds in operator parameters section, device turns to main operation screen automatically.

6.4. Accessing to the Technician Parameter Pages

MAIN OPERATION SCREEN

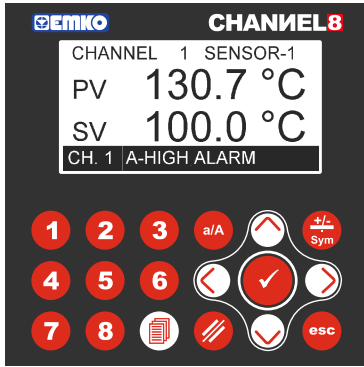

TECHNICIAN PARAMETERS SECTION PASSWORD SCREEN



When programming mode access button is pressed for 5 seconds, If technician password is different from 0, technician parameter section password screen will be observed, If technician password is 0 then technician parameter screen will be observed.

Press right or left button for selecting the password parameter.

TECHNICIAN PARAMETERS SECTION PASSWORD SCREEN



Press enter button for accessing to password entering screen.

TECHNICIAN PARAMETERS SECTION PASSWORD ENTERING SCREEN



Enter the technician parameter section password with cursor (lef, right, up and down) buttons.

TECHNICIAN PARAMETERS SECTION PASSWORD ENTERING SCREEN

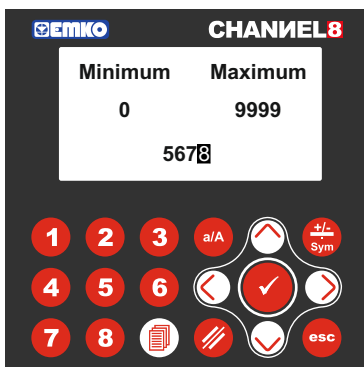

Press enter button for accessing to the technician section parameters.

TECHNICIAN PARAMETER SCREEN (PAGE - 1 "CHANNEL-1 PARAMETERS")

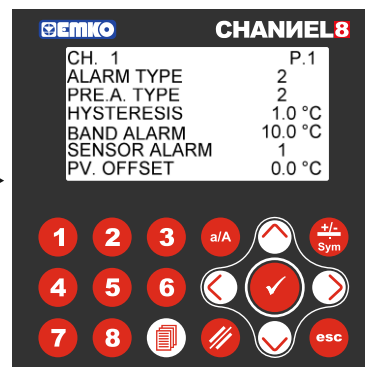

Press number (1,2,3,4,5,6,7 or 8) buttons for accessing the relevant channel's parameter screen. Press down button for accessing to next parameter page.



If no operation is performed for 20 seconds in technician parameters section, device turns to main operation screen automatically.

**TECHNICIAN PARAMETER SCREEN
(PAGE - 2)**

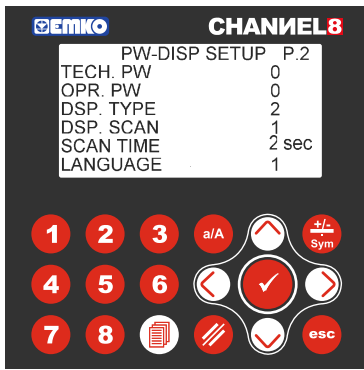

Press down button for accessing next parameter page, press up button for accessing previous parameter page.

**TECHNICIAN PARAMETER SCREEN
(PAGE - 3)**

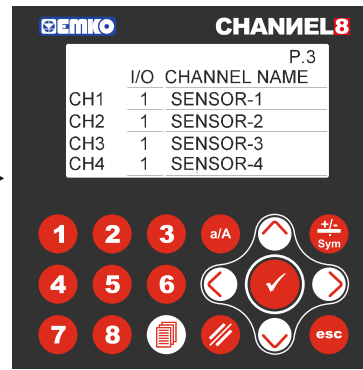

Press down button for accessing next parameter page, press up button for accessing previous parameter page.

**TECHNICIAN PARAMETER SCREEN
(PAGE - 4)**

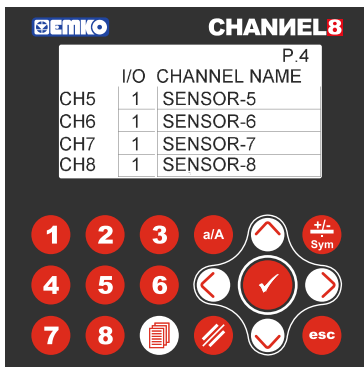

Press down button for accessing next parameter page, press up button for accessing previous parameter page.

**TECHNICIAN PARAMETER SCREEN
(PAGE - 5 "RS 232 PAGE")**



Press down button for accessing next parameter page, press up button for accessing previous parameter page.

**TECHNICIAN PARAMETER SCREEN
(PAGE - 6 "RS 485 PAGE")**



Press down button for accessing next parameter page, press up button for accessing previous parameter page.

**TECHNICIAN PARAMETER SCREEN
(PAGE - 7 "USB PAGE")**



Press down button for accessing next parameter page, press up button for accessing previous parameter page.



If the device has a optional RS485 communication then RS 485 page is observed, If the device has a optional USB communication then USB page is observed. Otherwise these pages are not observed.



If no operation is performed for 20 seconds in technician parameters section, device turns to main operation screen automatically.

TECHNICIAN PARAMETER SCREEN (PAGE - 8 "ETHERNET PAGE")

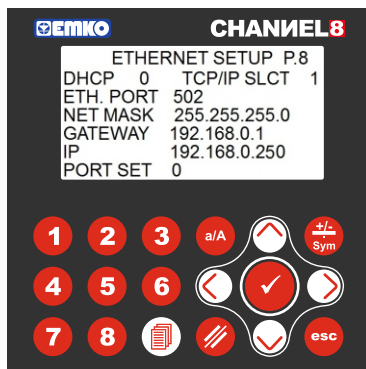

Press down button for accessing next parameter page, press up button for accessing previous parameter page.

TECHNICIAN PARAMETER SCREEN (PAGE - 9 "RTC PAGE")



Press up button for accessing previous parameter page, press escape button for return to main operation screen.



If the device has a optional ETHERNET communication then ETHERNET page is observed, otherwise this page is not observed.



If no operation is performed for 20 seconds in technician parameters section, device turns to main operation screen automatically.

6.5. Operator Pages Parameters Definitions

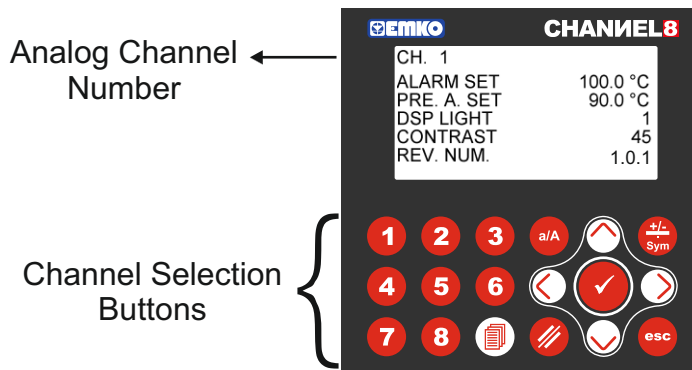

Parameter	Explanation	Unit	Min	Max	Default
ALARM SET	Alarm Set Value For Channel-X	°C	-200.0	650.0	100.0
PRE. A. SET	Pre-Alarm Set Value For Channel-X	°C	-200.0	650.0	90.0
DSP. BACKLIGHT	Display Backlight Mode	-	0	2	1
CONTRAST	Display Contrast Value	-	30	60	45

ALARM SET

Alarm set value for selected channel is can be adjusted according to this parameter.

PRE. A. SET

Pre-Alarm set value for selected channel is can be adjusted according to this parameter.

DSP LIGHT

Display backlight is can be controlled by this parameter value. If parameter value;

0 = LCD backlight is continuously OFF

1 = LCD backlight is continuously ON

2 = "power safe mode" If any button is not pressed during 30 secs. LCD backlight is automatically changed OFF mode, when any button is pressed LCD backlight is changed ON mode again.

CONTRAST

Display contrast value is can be controlled by this parameter value.

REV. NUM "Software Revision Number"

Device software revision number is can be seen by this parameter.

This parameter is can not be changed, it's only observed.

Alarm Set Parameters Modbus Addresses

Parameter Name	Modbus Address
CH-1 ALR. SET (*)	42050
CH-2 ALR. SET (*)	42054
CH-3 ALR. SET (*)	42058
CH-4 ALR. SET (*)	42062
CH-5 ALR. SET (*)	42066
CH-6 ALR. SET (*)	42070
CH-7 ALR. SET (*)	42074
CH-8 ALR. SET (*)	42078

Pre-Alarm Set Parameters Modbus Addresses

Parameter Name	Modbus Address
CH-1 P-ALR. SET (*)	42051
CH-2 P-ALR. SET (*)	42055
CH-3 P-ALR. SET (*)	42059
CH-4 P-ALR. SET (*)	42063
CH-5 P-ALR. SET (*)	42067
CH-6 P-ALR. SET (*)	42071
CH-7 P-ALR. SET (*)	42075
CH-8 P-ALR. SET (*)	42079



CH = CHANNEL

(*) These parameters are displayed on LCD screen with point, so that the parameters values are 10 times than the real values for modbus function.



Channel number is can be seen upper left side of the display and can be selected by pressing the channel selection buttons.



If no operation is performed for 20 seconds in operator parameters min, device turns to main operation screen automatically.

6.6. Technician Pages Parameters Definitions

6.6.1. Page-1 Parameters

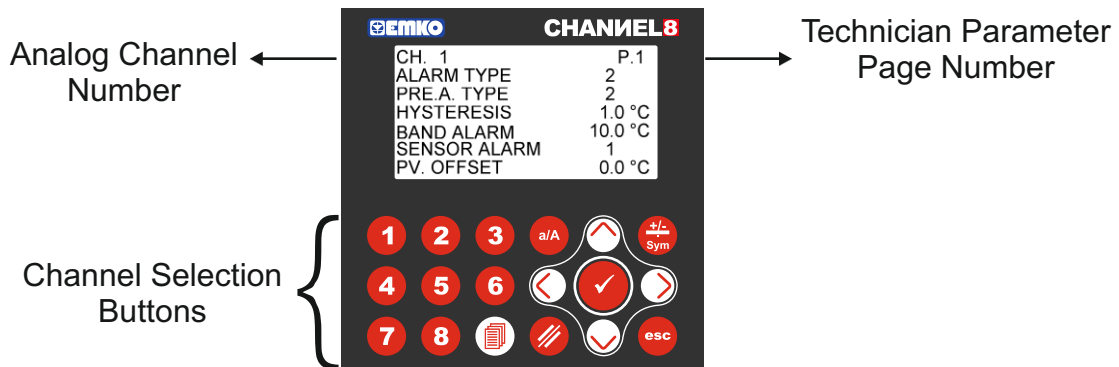

Parameter	Explanation	Unit	Min	Max	Default
ALARM TYPE	Alarm Type For Channel-X	-	1	3	2
PRE. A. TYPE	Pre-Alarm Type For Channel-X	-	1	3	2
HYSTERESIS	Hysteresis Value For Channel-X	°C	-400.0	400.0	1.0
BAND ALARM	Bandwith Value For Channel-X	°C	-400.0	400.0	10.0
SENSOR ALARM	Sensor Alarm Ena./Dis Selection For Channel-X	ENA/DIS	0	1	1
PV. OFFSET	Process Offset Value For Channel-X	°C	-50.0	50.0	0

ALARM TYPE

Alarm type for selected channel is can be adjusted according to this parameter. If parameter value,

- 1 = Low Alarm
- 2 = High Alarm
- 3 = Band Alarm is selected.

PRE. A. TYPE

Pre-Alarm type for selected channel is can be adjusted according to this parameter. If parameter value,

- 1 = Low Alarm
- 2 = High Alarm
- 3 = Band Alarm is selected.

HYSTERESIS

Hysteresis parameter value for Alarm and Pre-Alarm is can be adjusted by this parameter.

BAND ALARM

Bandwith for Band alarm is can be adjusted by this parameter value.

SENSOR ALARM

Sensor break alarm for selected channel is can be disable or enable by this parameter. If parameter value,

- 0 = Sensor break alarm disable
- 1 = Sensor break alarm enable

PV. OFFSET

Process offset value for selected channel is can be adjusted by this parameter.



Channel number is can be seen upper left side of the display and can be selected by pressing the channel selection buttons.



If no operation is performed for 20 seconds in technician parameters section, device turns to main operation screen automatically.

**Alarm Type Selection Parameters
Modbus Addresses**

Parameter Name	Modbus Address
CH-1 ALARM TYPE	42082
CH-2 ALARM TYPE	42085
CH-3 ALARM TYPE	42088
CH-4 ALARM TYPE	42091
CH-5 ALARM TYPE	42094
CH-6 ALARM TYPE	42097
CH-7 ALARM TYPE	42100
CH-8 ALARM TYPE	42103

**Pre-Alarm Type Selection Parameters
Modbus Addresses**

Parameter Name	Modbus Address
CH-1 PRE. A. TYPE	42083
CH-2 PRE. A. TYPE	42086
CH-3 PRE. A. TYPE	42089
CH-4 PRE. A. TYPE	42092
CH-5 PRE. A. TYPE	42095
CH-6 PRE. A. TYPE	42098
CH-7 PRE. A. TYPE	42101
CH-8 PRE. A. TYPE	42104

Hysteresis Parameters Modbus Addresses

Parameter Name	Modbus Address
CH-1 HYSTERESIS (*)	42052
CH-2 HYSTERESIS (*)	42056
CH-3 HYSTERESIS (*)	42060
CH-4 HYSTERESIS (*)	42064
CH-5 HYSTERESIS (*)	42068
CH-6 HYSTERESIS (*)	42072
CH-7 HYSTERESIS (*)	42176
CH-8 HYSTERESIS (*)	42180

**Band Alarm Selection Parameters
Modbus Addresses**

Parameter Name	Modbus Address
CH-1 BAND ALARM (*)	42053
CH-2 BAND ALARM (*)	42057
CH-3 BAND ALARM (*)	42061
CH-4 BAND ALARM (*)	42065
CH-5 BAND ALARM (*)	42069
CH-6 BAND ALARM (*)	42073
CH-7 BAND ALARM (*)	42177
CH-8 BAND ALARM (*)	42181

**Sensor Alarm Selection Parameters
Modbus Addresses**

Parameter Name	Modbus Address
CH-1 SENSOR ALARM	42084
CH-2 SENSOR ALARM	42087
CH-3 SENSOR ALARM	42090
CH-4 SENSOR ALARM	42093
CH-5 SENSOR ALARM	42096
CH-6 SENSOR ALARM	42099
CH-7 SENSOR ALARM	42102
CH-8 SENSOR ALARM	42105

**Process Value Offset Parameters
Modbus Addresses**

Parameter Name	Modbus Address
CH-1 PV. OFFSET (*)	42116
CH-2 PV. OFFSET (*)	42117
CH-3 PV. OFFSET (*)	42118
CH-4 PV. OFFSET (*)	42119
CH-5 PV. OFFSET (*)	42120
CH-6 PV. OFFSET (*)	42121
CH-7 PV. OFFSET (*)	42122
CH-8 PV. OFFSET (*)	42123

CH = CHANNEL



(*) These parameters are displayed on LCD screen with point, so that the parameters values are 10 times than the real values for modbus function.



If no operation is performed for 20 seconds in technician parameters section, device turns to main operation screen automatically.

6.6.2. Page-2 Parameters

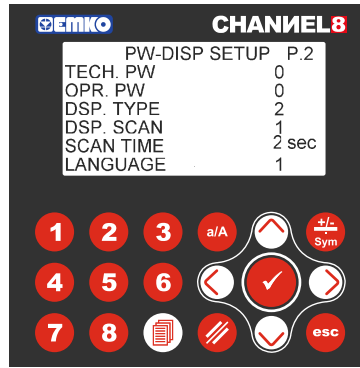

Parameter	Explanation	Unit	Min	Max	Default	Address
TECH. PW.	Technician Section Password	-	0	9000	0	42106
OPR. PW.	Operation Section Password	-	0	9000	0	42107
DSP. TYPE	Main Operation Screen Type	-	1	2	2	42128
DSP. SCAN	Display Scan ON/OFF	ON/OFF	0	1	1	42129
SCAN TIME	Display Scan Period	SEC.	1	3600	2	42130
LANGUAGE	Device Language Selection	-	0	1	1	42136

TECH. PW

Password for entering to the technician section is defined with this parameter. If it is 0, technician section accessed without entering password.

OPR. PW

Password for entering to the operator section is defined with this parameter. If it is 0, operator section accessed without entering password.

DSP. TYPE

Main operation screen type is adjusted by this parameter. If parameter value,
 1 = Multiple channel view
 2 = Single channel view is selected.

DSP. SCAN

Display channel scanner mode is adjusted by this parameter. If parameter value,
 0 = Display channel scanner mode OFF
 1 = Display channel scanner mode ON

SCAN TIME

Display scan period is adjusted by this parameter. All main operation screen is displayed during time defined by this parameter.

LANGUAGE

Device Language is selected by this parameter. If parameter value,
 0 = TÜRKÇE
 1 = ENGLISH



If no operation is performed for 20 seconds in technician parameters section, device turns to main operation screen automatically.

6.6.3. Page-3 and Page-4 Parameters

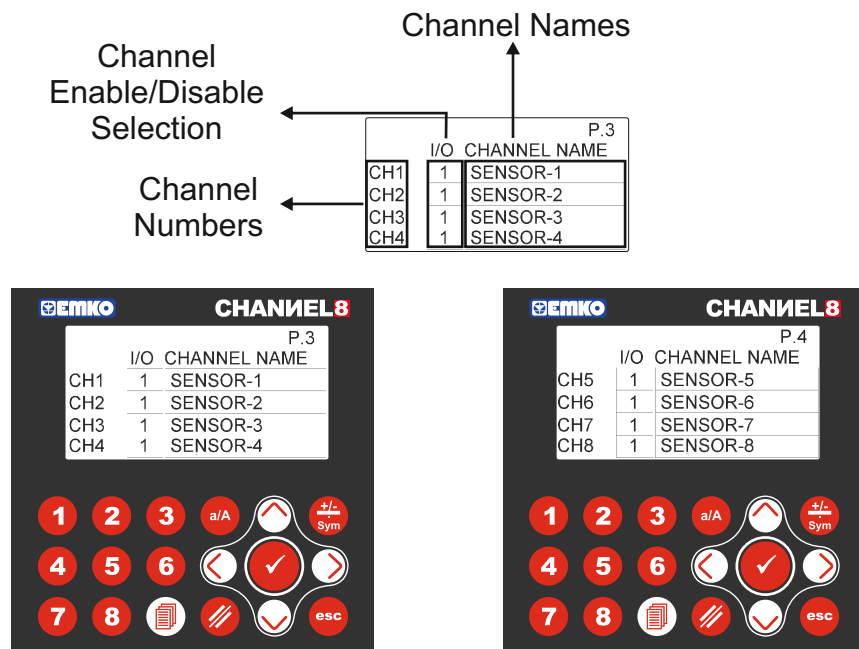

Parameter	Explantion	Unit	Min	Max	Default	Address
CH-1 NAME	Channel-1 Name	String	-	-	SENSOR-1	42000 - 42004
CH-2 NAME	Channel-2 Name	String	-	-	SENSOR-2	42005 - 42009
CH-3 NAME	Channel-3 Name	String	-	-	SENSOR-3	42010 - 42014
CH-4 NAME	Channel-4 Name	String	-	-	SENSOR-4	42015 - 42019
CH-5 NAME	Channel-5 Name	String	-	-	SENSOR-5	42020 - 42024
CH-6 NAME	Channel-6 Name	String	-	-	SENSOR-6	42025 - 42029
CH-7 NAME	Channel-7 Name	String	-	-	SENSOR-7	42030 - 42034
CH-8 NAME	Channel-8 Name	String	-	-	SENSOR-8	42035 - 42039
CH-1 I/O	Channel-1 Enable/Disable	ENA/DIS	0	1	1	42108
CH-2 I/O	Channel-2 Enable/Disable	ENA/DIS	0	1	1	42109
CH-3 I/O	Channel-3 Enable/Disable	ENA/DIS	0	1	1	42110
CH-4 I/O	Channel-4 Enable/Disable	ENA/DIS	0	1	1	42111
CH-5 I/O	Channel-5 Enable/Disable	ENA/DIS	0	1	1	42112
CH-6 I/O	Channel-6 Enable/Disable	ENA/DIS	0	1	1	42113
CH-7 I/O	Channel-7 Enable/Disable	ENA/DIS	0	1	1	42114
CH-8 I/O	Channel-8 Enable/Disable	ENA/DIS	0	1	1	42115

I/O “Channel Enable/Disable Selection Parameter”

Channel is enabled and disabled by this parameter. If channel is selected as a disabled this channel is can not be observed in main operation scren for single view mode, channel alarm is not be controlled and analogue value for this channel is can not be recording on USB file. If parameter value,

0 = Channel is disable

1 = Channel is enable

CHANNEL NAME “Channels label definition ”

All channels have their own label, is displayed in main operation screen. channel labels is can be adjusted by this parameter. Channel labels are can be adjusted maximum 10 characters.



CH = CHANNEL

If no operation is performed for 20 seconds in technician parameters section, device turns to main operation screen automatically.

6.6.4. RS232 Setup Pages Parameters



Parameter	Explanation	Unit	Min	Max	Default	Address
BAUDRATE	Baudrate For RS232 Communication	-	1	6	6	42124
PARITY	Parity For RS232 Communication	-	0	2	0	42125
STOP BIT	Stop Bit For RS232 Communication	-	1	2	1	42126
ID	ID For RS232 Communication	-	1	247	1	42127

BAUDRATE

Modbus communication baudrate for RS232 is can be adjusted by this parameter. If parameter value,

- 1 = 4800
- 2 = 9600
- 3 = 19200
- 4 = 38400
- 5 = 57600
- 6 = 115200

PARITY

Modbus communication parity bit for RS232 is can be adjusted by this parameter. If parameter value,

- 0 = No Parity
- 1 = ODD Parity
- 2 = EVEN Parity

STOP BIT

Modbus communication stop bit for RS232 is can be adjusted by this parameter. If parameter value,

- 1 = 1 Stop bit
- 2 = 2 Stop bits

ID

Modbus communication device ID for RS232 is can be adjusted by this parameter. This parameter value is can be adjusted from 1 to 247 (except 85 and 170).



If no operation is performed for 20 seconds in technician parameters section, device turns to main operation screen automatically.

6.6.5. RS485 Setup Pages Parameters



Parameter	Explanation	Unit	Min	Max	Default	Address
BAUDRATE	Baudrate For RS485 Communication	-	1	6	2	42132
PARITY	Parity For RS485 Communication	-	0	2	0	42133
STOP BIT	Stop Bit For RS485 Communication	-	1	2	1	42134
ID	ID For RS485 Communication	-	1	247	1	42135

BAUDRATE

Modbus communication baudrate for RS485 is can be adjusted by this parameter. If parameter value,

- 1 = 4800
- 2 = 9600
- 3 = 19200
- 4 = 38400
- 5 = 57600
- 6 = 115200

PARITY

Modbus communication parity bit for RS485 is can be adjusted by this parameter. If parameter value,

- 0 = No Parity
- 1 = ODD Parity
- 2 = EVEN Parity

STOP BIT

Modbus communication stop bit for RS485 is can be adjusted by this parameter. If parameter value,

- 1 = 1 Stop bit
- 2 = 2 Stop bits

ID

Modbus communication device ID for RS485 is can be adjusted by this parameter.



If the device has an optional RS485 communication then RS 485 page is observed, Otherwise these page is not observed.



If no operation is performed for 20 seconds in technician parameters section, device turns to main operation screen automatically.

6.6.6. USB Setup Page Parameters



Parameter	Explanation	Unit	Min	Max	Default	Address
FILE NAME	USB File Name	String	-	-	CHAN8.txt	42040 - 42044
LABEL	USB Label	String	-	-	SAMPLE	42045 - 42049
SAVE TIME	USB Time Record ENA/DIS	-	0	1	1	42137
SAMP. TIME	USB Record Time Interval	Sec.	0	3600	1	42138

FILE NAME

USB file name for recording analogue values is can be adjusted by this parameter. File name can be adjusted maximum 10 characters. Recording file on usb is “csv” format and all data is seperated each other with tab. Example file format is explained below.

LABEL

When the analogue values are recorded on USB file, user can be defined label for this recording. Label can be adjusted maximum 10 characters. Label are recorded at the end of every lines of file.

SAVE TIME

When the analogue values are recorded on USB file, user can be save the recording time on the file. Recording time is recorded at the beginning of every lines of file.

- 0 = Real time is not recorded on USB file
- 1 = Real time is recorded on USB file for every sample

SAMPLE TIME

Record time interval is can be adjusted by this parameter. Analogue values are recorded on USB file with this time interval. If this parameter value is 0 usb recording is disabled.

FLASH MEM. PLUGGED “USB Flash Memory Stick Detected Test”

When the usb flash memory stick is plugged to the device FLASH MEM.PLUGGED led is light on. This parameter is can not be changed, it’s used to inform the user whether USB is plugged.

USB Recording File Example

2011-06-23-17:26:08	130.6	129.1	130.5	129.5	130.0	129.9	130.3	129.1	SAMPLE
2011-06-23-17:26:09	130.6	129.1	130.5	129.5	130.0	129.9	130.3	129.1	SAMPLE
2011-06-23-17:26:10	130.6	129.1	130.5	129.5	130.0	129.9	130.3	129.1	SAMPLE
2011-06-23-17:26:12	130.6	129.1	130.5	129.5	130.0	129.9	130.3	129.1	SAMPLE
2011-06-23-17:26:13	130.6	129.1	130.5	129.5	130.0	129.9	130.3	129.1	SAMPLE
Recording Time	CH-1 Value	CH-2 Value	CH-3 Value	CH-4 Value	CH-5 Value	CH-6 Value	CH-7 Value	CH-8 Value	Label

CH = CHANNEL



If the device has a optional USB communication then USB page is observed. Otherwise these page is not observed.



If no operation is performed for 20 seconds in technician parameters section, device turns to main operation screen automatically.

6.6.7. ETHERNET Setup Page Parameters

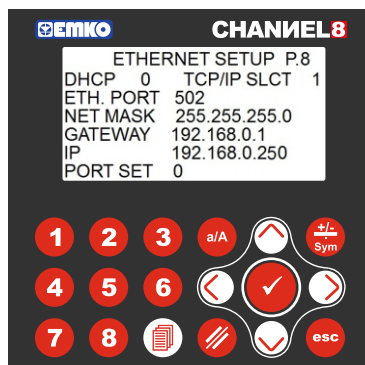

Parameter	Explanation	Unit	Min	Max	Default	Address
DHCP	DHCP Enable /Disable (**)	ENA/DIS	0	1	0	42150
ETH. PORT	ETHERNET Port No (**)	-	1	65535	502	42151
ETH. IP NO	Ethernet IP No (**)	-	-	-	192.168.0.250	42152 - 42153
ETH. NETMASK	Ethernet Netmask (**)	-	-	-	255.255.255.0	42154 - 42155
ETH. GATEWAY	Ethernet Gateway (**)	-	-	-	192.168.0.1	42156 - 42157
ETH. TCP/IP SLCT	TCP/IP Select (**)	-	0	1	0	-
DEVICE MAC ADR.	Device MAC Address (**)	-	-	-	-	42158 - 42160

DHCP

DHCP is an automatic configuration protocol used on IP networks, If DHCP is enable, device is adjust our ethernet communication configuration parameters (IP, Netmask, Gateway) dynamicaly for your network system. If DHCP is disable, you must adjust ethernet configuration parameters (IP, Netmask, Gateway) for your network system. If parameter value,

0 = DHCP DISABLE

1 = DHCP ENABLE

ETH.PORT

Ethernet port number is can be adjusted by this parameter.

NET MASK

Subnet mask for ethernet communication is can be adjusted by this parameter. If DHCP is selected as a enable there is no need to adjust to this parameter, if DHCP is selected as a disable then user must adjust this parameter according to the their own network system.

GATEWAY

Gateway for ethernet communication is can be adjusted by this parameter. If DHCP is selected as a enable there is no need to adjust to this parameter, if DHCP is selected as a disable then user must adjust this parameter according to the their own network system.

IP

IP address for ethernet communication is can be adjusted by this parameter. If DHCP is selected as a enable there is no need to adjust to this parameter, if DHCP is selected as a disable then user must adjust this parameter.

PORT SET

Ethernet port configuration is setting by this parameter, After the all parameter adjusted according to system needs, this parameter value is must be adjusted to 1 for ethernet port setting, after ethernet port setting is completed this parameter value is turn to zero automatically.

TCP/IP SLCT

TCP/IP protocol is selected by this parameter. **0 = Modbus RTU Over TCP/IP** **1 = Modbus RTU TCP/IP**



(**) These parameters are only read for modbus function.



If the device has a optional ETHERNET communication then ETHERNET pages is observed. Otherwise these pages are not observed.



If no operation is performed for 20 seconds in technician parameters section, device turns to main operation screen automatically.

6.6.8. REAL TIME (RTC) Setup Page Parameters



Press and hold on 3 seconds Enter button for setting the RTC time value.

Parameter	Explanation	Unit	Min	Max	Default
YEAR	Year Value For RTC Time	-	2010	3000	-
MONTH	Month Value For RTC Time	-	1	12	-
DAY	Day Value For RTC Time	-	1	31	-
HOUR	Hour Value For RTC Time	-	0	23	-
MINUTE	Minute Value For RTC Time	-	0	59	-
SECOND	Second Value For RTC Time	-	0	59	-

YEAR

Year value for RTC time is adjusted by this parameter.

MONTH

Month value for RTC time is adjusted by this parameter.

DAY

Day value for RTC time is adjusted by this parameter.

HOUR

Hour value for RTC time is adjusted by this parameter.

MINUTE

Minute value for RTC time is adjusted by this parameter.

SECOND

Second value for RTC time is adjusted by this parameter.



If no operation is performed for 20 seconds in technician parameters section, device turns to main operation screen automatically.

7. Operation Graphics of Alarm and Pre-Alarm Types

High Alarm

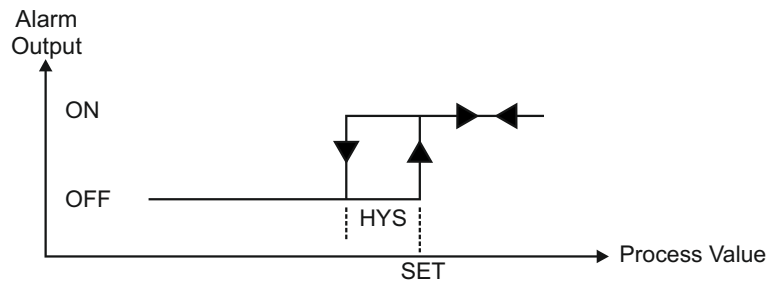

Low Alarm

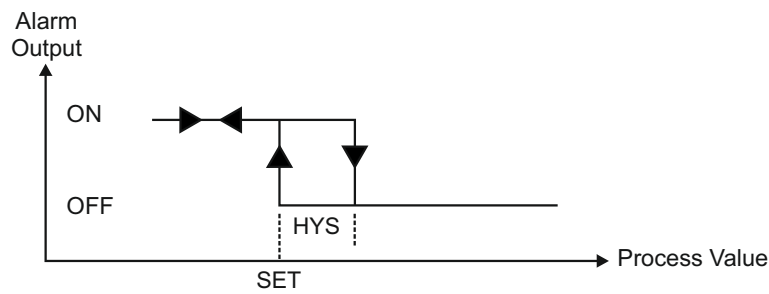

Band Alarm

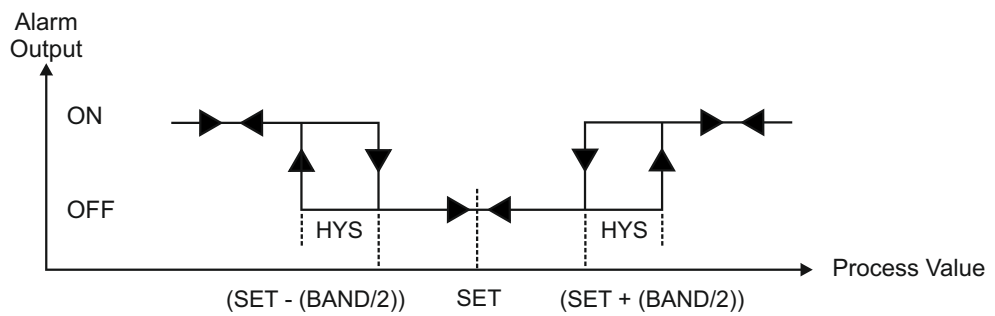

SET = Alarm or Pre-Alarm Set value
HYS = Hysteresis value for Alarm and Pre-Alarm output
BAND = Bandwidth for Band Alarm.

8. Modbus Addresses

8.1. Output Addresses

OUTPUT ADDRESSES		Unit	Min	Max	Default	Address
CH-1 ALARM OUT	Channel-1 Alarm Output Status	-	-	-	-	00001
CH-2 ALARM OUT	Channel-2 Alarm Output Status	-	-	-	-	00002
CH-3 ALARM OUT	Channel-3 Alarm Output Status	-	-	-	-	00003
CH-4 ALARM OUT	Channel-4 Alarm Output Status	-	-	-	-	00004
CH-5 ALARM OUT	Channel-5 Alarm Output Status	-	-	-	-	00005
CH-6 ALARM OUT	Channel-6 Alarm Output Status	-	-	-	-	00006
CH-7 ALARM OUT	Channel-7 Alarm Output Status	-	-	-	-	00007
CH-8 ALARM OUT	Channel-8 Alarm Output Status	-	-	-	-	00008
GEN. ALR. OUT	General Alarm Output Status	-	-	-	-	00009
GEN.PREALR.OUT	General Pre-Alarm Output Status	-	-	-	-	00010

Note-1: Outputs status are can be readed with modbus function-1 (read coils). Device's response for modbus function-1 is always 2 byte data although the modbus function request less than 9 outputs port.

8.2. Process Values Addresses

PROCESS VALUES ADDRESSES		Unit	Min	Max	Default	Address
CH-1 P. VALUE	Channel-1 Process Value	°C	-	-	-	30001
CH-2 P. VALUE	Channel-2 Process Value	°C	-	-	-	30002
CH-3 P. VALUE	Channel-3 Process Value	°C	-	-	-	30003
CH-4 P. VALUE	Channel-4 Process Value	°C	-	-	-	30004
CH-5 P. VALUE	Channel-5 Process Value	°C	-	-	-	30005
CH-6 P. VALUE	Channel-6 Process Value	°C	-	-	-	30006
CH-7 P. VALUE	Channel-7 Process Value	°C	-	-	-	30007
CH-8 P. VALUE	Channel-8 Process Value	°C	-	-	-	30008

Note-2: Process values are can be readed with modbus function-4 (read input register). Because of the process values are displayed on LCD screen with point, the reading values from modbus is 10 times than the real values.

9. Specifications

Device Type	: 8 Channel PT-100 Scanner
Housing & Mounting	: 96mm x 96mm x 87.5mm 1/4 DIN 43700 plastic housing for panel mounting. Panel cut-out is 92 x 92mm.
Protection Class	: NEMA 4X (IP65 at front, IP20 at rear)
Weight	: Approximately 0.4Kg.
Environmental Ratings with none	: Standard, indoor at an altitude of less than 2000 meters condensing humidity
Storage / Operating Temperature:	-20 °C to +70 °C / 0 °C to +50 °C
Storage / Operating Humidity	: 90 % max. (None condensing)
Installation	: Fixed installation
Overvoltage Category	: II
Pollution Degree	: II. office or workplace, none conductive pollution
Operating Conditions	: Continuous
Device Supply Voltage and Power	: 100 - 240 V ~ (-%15 / +%10) 50/60 Hz. 7VA 24 V ~ (-%15 / +%10) 50/60 Hz. 7VA 24 V === (-%15 / +%10) 7W
Output Card Supply Voltage and Power	: 24 V===(±15%) - 5W (for Transistor output type)
Analogue Inputs	: PT 100 (IEC751) (ITS90)
Accuracy	: ± 0,25% of full scale
Line Compensation	: Maximum 10 Ω
Sensor Break Protection	: Upscale
Sampling Time	: 400msecs.
Input Resistance	: > 10MΩ
Digital Output	: Transistor or relay outputs
Transistor Output	: PNP(source) type transistor output (Max. 1A@24V===)
Relay Output	: Resistive Load 5A@250V~ (Electrical Life : 100.000 operation (Full Load))
Standard Communication	: RS-232 Communication (For Modbus RTU)
Optional Communication	: RS-485 (For Modbus RTU) "500V~ isolated" 10Mbits/s Ethernet (For Modbus RTU Over TCP - Modbus RTU TCP/IP selectable) "1500V~ isolated" USB 2.0 (Data logging over Flash Stick Memory)
Display	: 128 x 64 pixel graphical LCD
Approvals	: GOST-R, CE

10. Other Informations

Manufacturer Information:

Emko Elektronik Sanayi ve Ticaret A.Ş.

Demirtaş Organize Sanayi Bölgesi Karanfil Sk. No:6 16369

BURSA/TURKEY Phone : +90 224 261 1900 Fax : +90 224 261 1912

Repair and Maintenance Service Information:

Emko Elektronik Sanayi ve Ticaret A.Ş.

Demirtaş Organize Sanayi Bölgesi Karanfil Sk. No:6 16369

BURSA/TURKEY Phone : +90 224 261 1900 Fax : +90 224 261 1912



Thank you very much for your preference to use Emko Elektronik Products.

www.emkoelektronik.com.tr